

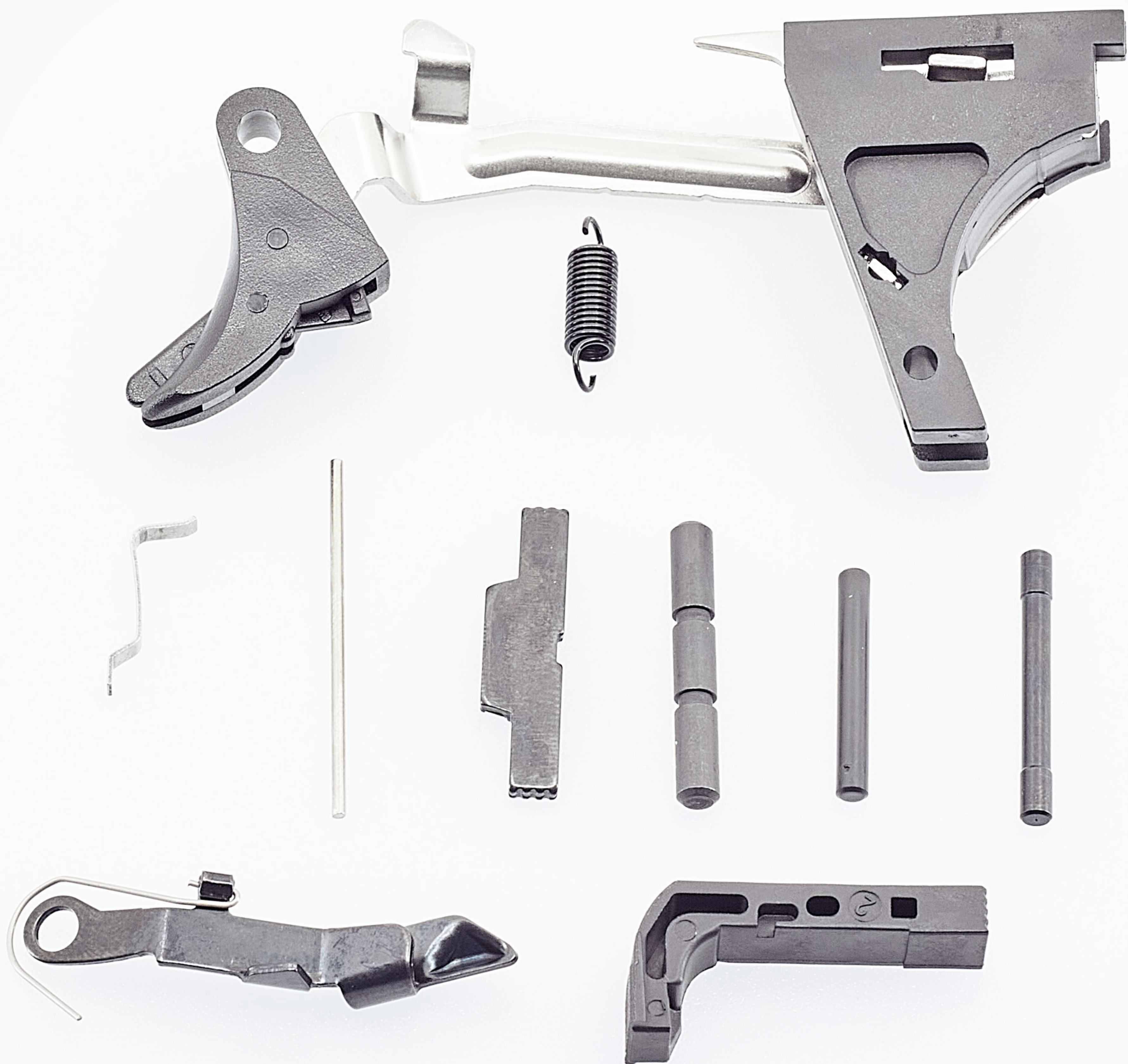

**JE MACHINE TECH**

**TS-LPKG17**



# GLOCK 17 LOWER PARTS KIT GEN 1-3

Compatible w/full sized polymer 80% frames (PF940v2) & Glock 17 Connector 5lb.

- ✔ Slide Stop Release with Spring
- ✔ Locking Block Pin
- ✔ Magazine Release
- ✔ Magazine Release Spring
- ✔ Slide Lock
- ✔ Slide Lock Spring
- ✔ Trigger Housing Pin
- ✔ Trigger Housing with 336 Ejector
- ✔ Trigger Pin
- ✔ Trigger Spring
- ✔ Trigger with Trigger Bar

Trigger with Trigger Bar and Trigger Housing are bagged individually and they need to be assembled by users

(909) 972 6545

www.jemachinetech.us

8885 White Oak Ave #103, Rancho Cucamonga CA 91730



**JE MACHINE TECH**

**TS-LPKG19**

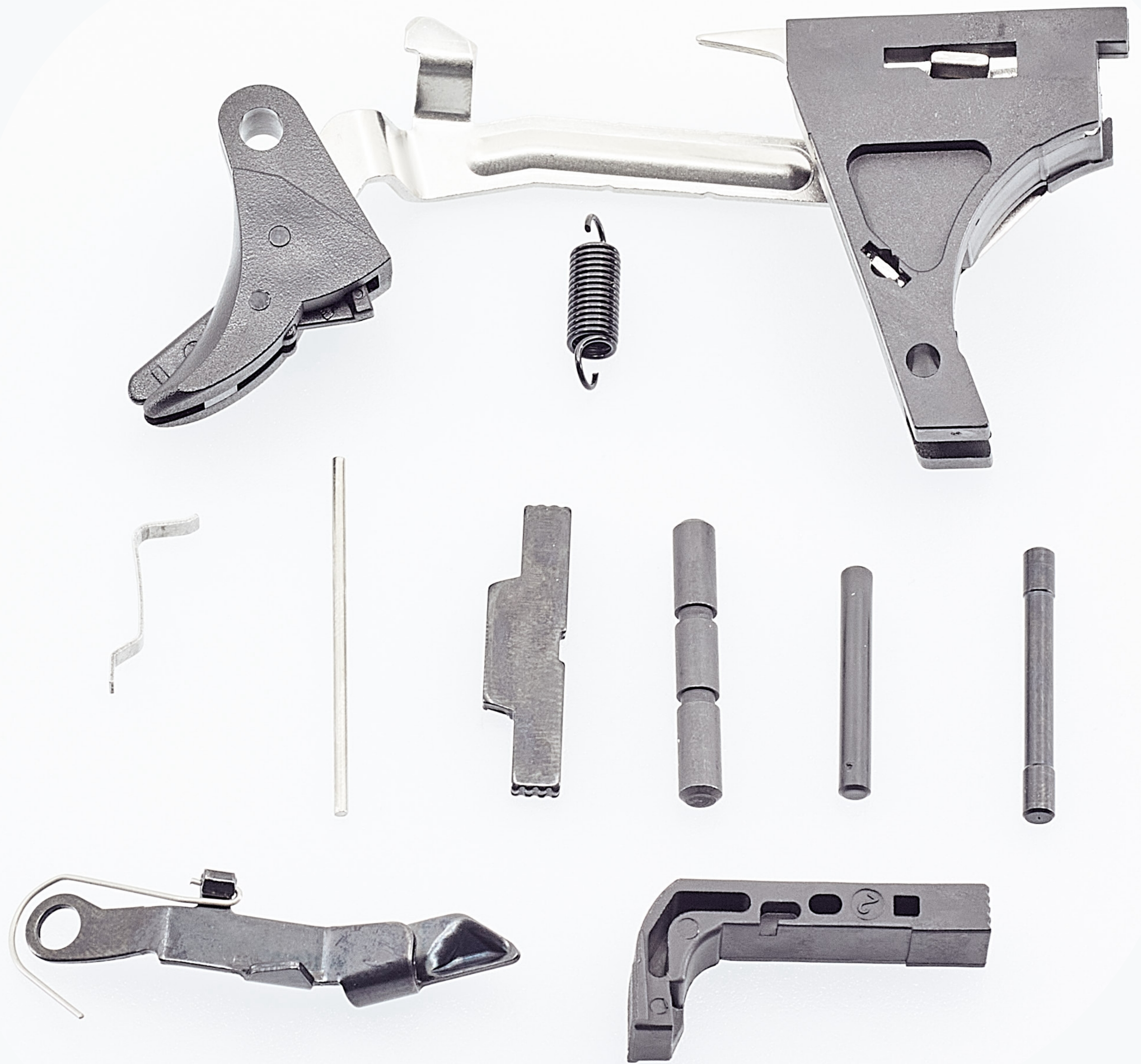

# GLOCK 19 LOWER PARTS KIT GEN 1-3

Lower Parts Kit trigger assembly fits and compatible fits and compatible for Glock 19/23.

- ✓ Mag Catch Spring
- ✓ Mag Release
- ✓ Slide Lock
- ✓ Slide Lock Spring
- ✓ Trigger Housing with Ejector
- ✓ 5lb Connector
- ✓ Trigger Spring
- ✓ Trigger with Trigger Bar
- ✓ Trigger Pin

Trigger with Trigger Bar and Trigger Housing are bagged individually and they need to be assembled by users

(909) 972 6545

www.jemachinetech.us

8885 White Oak Ave #103, Rancho Cucamonga CA 91730



**JE MACHINE TECH**

**TS-LPKG43**

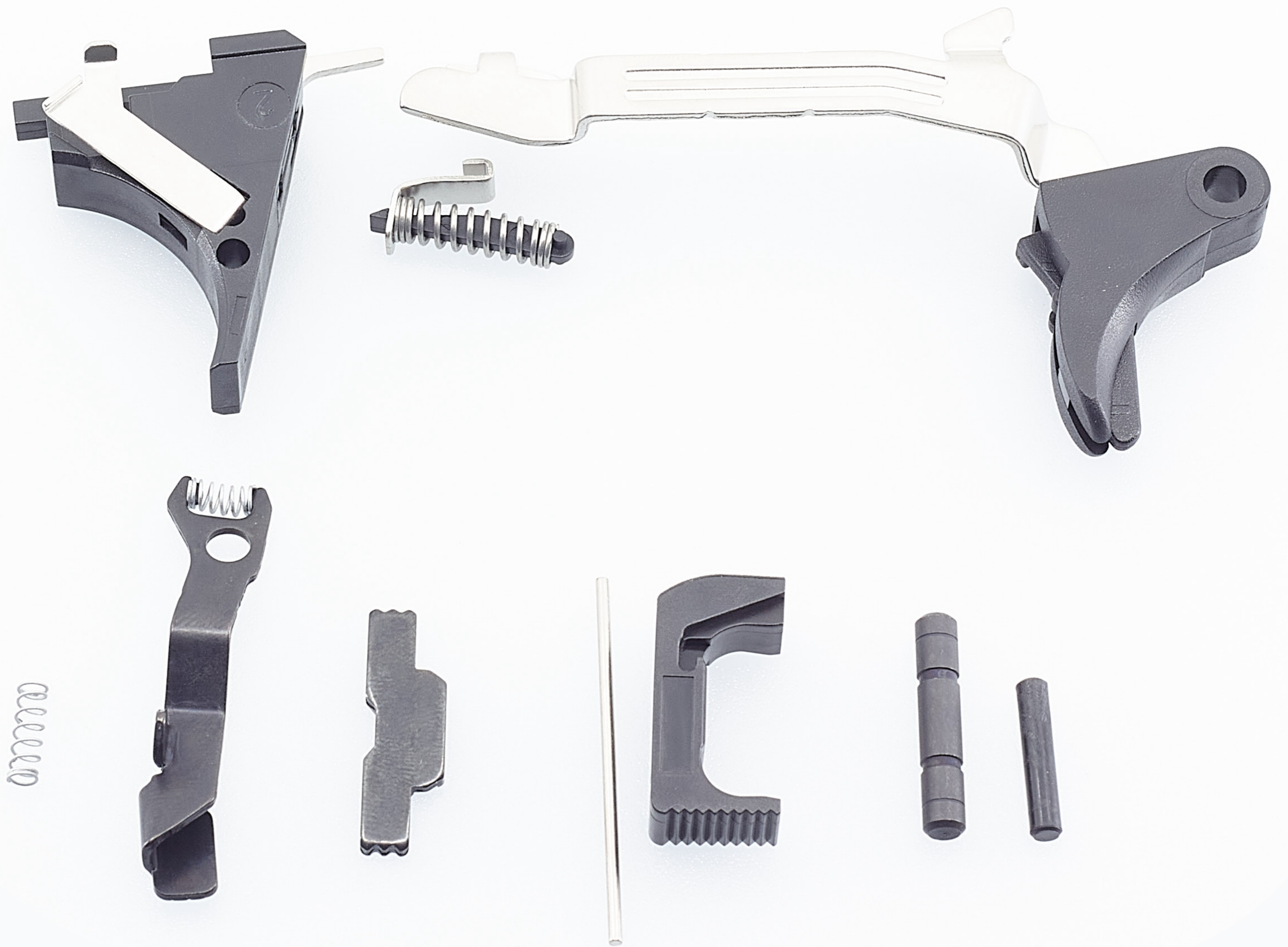

# GLOCK 43 9MM COMPLETE LOWER PARTS KIT

Complete Glock 43 lower part kit includes the following components:

- ✔ Slide lock
- ✔ Slide stop lever
- ✔ Trigger housing pin
- ✔ Trigger pin
- ✔ Slide lock spring
- ✔ Mag catch
- ✔ Mag catch spring
- ✔ Trigger & trigger bar
- ✔ Trigger housing

(909) 972 6545

[www.jemachinetech.us](http://www.jemachinetech.us)

8885 White Oak Ave #103, Rancho Cucamonga CA 91730



**JE MACHINE TECH**

**PS-BFSC4**



# GEN.3 223 SILENT RECOIL SPRING BUFFER SPRING SYSTEM

The JE Machine AR-15 Silent Recoil Buffer Spring System is a drop-in replacement for the traditional buffer spring and buffer for the AR platform. This revolutionary patented one-piece design guide rod eliminates the risk of breaking as compared to other cap screwed recoil spring systems.

The revolutionary anti-vibration and anti-friction design results in a much smoother cycling rifle with none of the cheese grading sound that is typical of the standard buffer components.



- ✔ Self-contained & drop-in design for easy installation
- ✔ Reduce felt recoil
- ✔ Type III hard-coat anodized 6061-T6 aluminum guide rod for durability



- ✔ No cap screw in the front compared to other recoil spring systems to prevent breaking and improve reliability
- ✔ For carbine buffer tube only, not compatible with rifle buffer tube

(909) 972 6545

www.jemachinetech.us

8885 White Oak Ave #103, Rancho Cucamonga CA 91730



**JE MACHINE TECH**

**PS-BTM2**



Available Colors



# AR-15/AR-10 MIL-SPEC 6 POSITION SLOTTED BUFFER TUBE

This JE Machine AR-15/AR-10 skeletonized 6 position buffer tube gives your rifle a customized aesthetic look. The slotted design reduces the overall weight of your rifle while the detent lock prevents the tube from rotating when firing.



✔ Unique slot design pattern for weight deduction and a more aesthetic look

✔ Type III hard-coat anodized 6061-T6 aluminum

✔ 6 positions Mil-Spec diameter buffer tube



✔ Detent-lock prevents tube rotation

✔ Accepts all Mil-Spec dimension stocks

✔ AR-15 & AR-10 compatible

✔ Available colors: Black/Tan/  
OD Green/Red/Blue

(909) 972 6545

www.jemachinetech.us

8885 White Oak Ave #103, Rancho Cucamonga CA 91730



**JE MACHINE TECH**

**PS-BTM3**



Available Colors



# AR-15/AR-10 MIL-SPEC 6 POSITION ARROW BUFFER TUBE

This JE Machine AR-15/AR-10 skeletonized 6 position buffer tube gives your rifle a customized aesthetic look. The arrow design reduces the overall weight of your rifle.

The detent lock prevents the tube from rotating when firing.



- ✔ Unique arrow design pattern for weight deduction and a more aesthetic look
- ✔ Type III hard-coat anodized 6061-T6 aluminum
- ✔ 6 position Mil-Spec diameter buffer tube



- ✔ Detent-lock prevents tube rotation
- ✔ Accepts all Mil-Spec dimension stocks
- ✔ AR-15 & AR-10 compatible
- ✔ Available colors: Black/Tan/  
OD Green/Red/Blue

(909) 972 6545

www.jemachinetech.us

8885 White Oak Ave #103, Rancho Cucamonga CA 91730



**JE MACHINE TECH**

**PS-MZ8**



# SIDEWINDER BLAST DIFFUSER FOR .556/.223

The JE Machine sidewinder blast diffuser is engineered to divert the concussion and side blast forward of the weapon system instead of venting to the side as seen with the traditional devices.

Additionally, the Sidewinder aids in minimizing dust when firing from a prone position that would traditionally be seen when firing with a standard flash hider or muzzle brake.



- ✔ Directs concussion and muzzle blast forward
- ✔ Improves comfort and safety for the shooter and those nearby the firing line
- ✔ Limits any dust while firing
- ✔ No restrictions associated with silencers



- ✔ 1/2-28 thread for .223 / 5.56 only
- ✔ Black nitride finished
- ✔ Fluted design

(909) 972 6545

www.jemachinetech.us

8885 White Oak Ave #103, Rancho Cucamonga CA 91730



**JE MACHINE TECH**

**PS-223MLK15G**



Sizes (")	Weight(oz)
7	11.10
10	14.05
12	14.95
15	17.20
Available Colors	

# AR-15 M-LOK FREE FLOAT SLANT VERSATILE QUAD RAIL HANDGUARD

This JE Machine AR-15 handguard eliminates the top center rail for better grip and weight reduction. This innovative handguard also includes integrated anti-rotation tabs keeping the handguard secure and stable.

The clamp-on system provides easy installation. 2 built-in quick disconnect sling sockets are located at 3 and 9 o'clock positions.



- ✔ Clamp on system, no timing required for easy installation
- ✔ Type III hard-coat anodized 6061-T6 aluminum
- ✔ Full Picatinny rail on top and fixed Picatinny rails at 3,6,9 o'clock positions near front
- ✔ M-Lok compatible



- ✔ Smooth middle for ergonomic grip
- ✔ 2 built-in QD sockets
- ✔ Anti-rotation tabs
- ✔ Steel barrel nut and all mounting hardware included
- ✔ 1.357" ID
- ✔ Available in 7"/10"/12"/15"

(909) 972 6545

www.jemachinetech.us

8885 White Oak Ave #103, Rancho Cucamonga CA 91730





**JE MACHINE TECH**

**PS-223MLK15HBLK**



Sizes (")	Weight(oz)
15	21.50
Available Colors	
<input type="radio"/>	

# AR-15 M-LOK COMBAT FREE FLOAT QUAD RAIL HANDGUARD

This JE Machine AR-15 handguard eliminates the top center rail for better grip and weight reduction, while the clamp-on system provides easy installation.

This innovative handguard also includes integrated anti-rotation tabs keeping the handguard secure and stable.



- ✔ Clamp-on system, no timing required for easy installation
- ✔ Type III hard-coat anodized 6061-T6 aluminum
- ✔ Full Picatinny rail on top and fixed Picatinny rails at 3,6,9 o'clock positions near front
- ✔ Anti-slip screws at 3,6 o'clock positions



- ✔ Smooth middle for ergonomic grip
- ✔ Steel barrel nut and all mounting hardware included
- ✔ 1.315" ID
- ✔ Available in 15"

(909) 972 6545

www.jemachinetech.us

8885 White Oak Ave #103, Rancho Cucamonga CA 91730



**JE MACHINE TECH**

**PS-223MLK4E**



Sizes (")	Weight(oz)
4	6.05
7	7.90
9	9.25
12	11.15
15	12.90
Available Colors	

# AR-15 M-LOK SUPER SLIM FREE FLOAT HANDGUARD

This JE Machine AR-15 handguard is designed to be free float. The minimalist design gives your AR-15 a slick and streamlined appearance. We have removed excess weight while retaining structural integrity.

This innovative handguard also includes an integrated anti-rotation tabs keeping the handguard secure and stable.



- Free float and lightweight design
- Fastened by 6 head screws
- Type III hard-coat anodized 6061-T6 aluminum
- Full picatinny rail on top
- M-Lok Compatible



- Steel barrel nut and all mounting hardware included
- 1.315" ID
- Anti-rotation tabs
- Available in 4"/7"/9"/12"/15"

(909) 972 6545

www.jemachinetechn.com

8885 White Oak Ave #103, Rancho Cucamonga CA 91730



**JE MACHINE TECH**

**PS-BTM4**



Available Colors

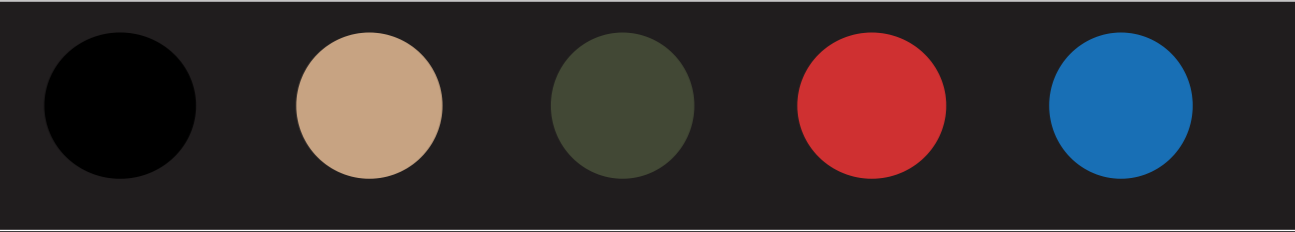

# AR-15/AR-10 6 POSITION DOTTED BUFFER TUBE

This JE Machine AR-15/AR-10 skeletonized 6 position buffer tube provides your rifle with a customized aesthetic look. The dotted design reduces the overall weight of your rifle.

The detent lock prevents the tube from rotating when firing.



- ✔ Unique dot design pattern for weight deduction and a more aesthetic look
- ✔ Type III hard-coat anodized 6061-T6 aluminum
- ✔ 6 position Mil-Spec diameter buffer tube



- ✔ Detent-lock prevents tube rotation
- ✔ Accepts all Mil-Spec dimension stocks
- ✔ AR-15 & AR-10 compatible
- ✔ Available colors: Black/Tan/  
OD Green/Red/Blue

(909) 972 6545

www.jemachinetech.us

8885 White Oak Ave #103, Rancho Cucamonga CA 91730



**JE MACHINE TECH**

**PS-BTMS2**



Available Colors



# AR15/AR-10 MIL SPEC 8 POSITION ANTI-FRICTION BUFFER TUBE

The JE Machine AR-15/AR-10 8 position buffer tube gives your rifle a customized aesthetic look. The recessed design not only reduces weight, it also decreases friction with tight-fitting stocks, while ensuring integrity in critically stressed areas.

The detent lock prevents the tube from rotating when firing.



- ✔ Recessed pockets for weight deduction and a more aesthetic look
- ✔ 3 drain holes for marine environments
- ✔ Type III hard-coat anodized 6061-T6 aluminum
- ✔ 8 position Mil-Spec diameter buffer tube



- ✔ Detent-lock prevents tube rotation
- ✔ Accepts all Mil-Spec dimension stocks
- ✔ AR-15 & AR-10 compatible

(909) 972 6545

www.jemachinetech.us

8885 White Oak Ave #103, Rancho Cucamonga CA 91730



**JE MACHINE TECH**

**PS-BTMS5**

(909) 972 6545

www.jemachinetech.us

8885 White Oak Ave #103, Rancho Cucamonga CA 91730



Available Colors



# AR15/AR-10 MIL-SPEC 6 POSITION FLUTED BUFFER TUBE

The JE Machine AR-15/AR-10 6 position buffer tube gives your rifle a customized aesthetic look. The fluted design reduces weight and decreases friction with tight-fitting stocks while ensuring integrity in critically stressed areas.

The detent lock prevents the tube from rotating when firing.



- ✔ Deep Fluting for weight deduction and a more aesthetic look
- ✔ 3 drain holes for marine environments
- ✔ Type III hard-coat anodized 6061-T6 aluminum
- ✔ 6 position Mil-Spec diameter buffer tube



- ✔ Detent-lock prevents tube rotation
- ✔ Accepts all Mil-Spec dimension stocks
- ✔ AR-15 & AR-10 compatible
- ✔ Available colors: Black/Tan/OD Green /Red/Blue



**JE MACHINE TECH**

**PS-ST2B**



Available Colors



# JE MACHINE M4 COLLAPSIBLE AR-15 BUTTSTOCK

This JE Machine AR-15 buttstock is made of impact-resistant, high-strength polymer material.



- ✔ High quality injected molded polymer
- ✔ Fits Mil-Spec carbine buffer tubes



- ✔ CA compliant edition available
- ✔ Available colors: Black/Tan

(909) 972 6545

www.jemachinetechnology.com

8885 White Oak Ave #103, Rancho Cucamonga CA 91730



**JE MACHINE TECH**

**PS-223MLK7E**



Sizes (")	Weight(oz)
4	6.05
7	7.90
9	9.25
12	11.15
15	12.90
Available Colors	

# AR-15 M-LOK SUPER SLIM FREE FLOAT HANDGUARD

This JE Machine AR-15 handguard is designed to be free float. The minimalist design gives your AR-15 a slick, streamlined appearance. We have removed excess weight while retaining structural integrity.

This innovative handguard also includes an integrated anti-rotation tabs keeping the handguard secure and stable.



- ✔ Free float and lightweight design
- ✔ Fastened by 6 head screws
- ✔ Type III hard-coat anodized 6061-T6 aluminum
- ✔ Full picatinny rail on top
- ✔ M-Lok Compatible



- ✔ Steel barrel nut and all mounting hardware included
- ✔ 1.315" ID
- ✔ Anti-rotation tabs
- ✔ Available in 4"/7"/9"/12"/15"

(909) 972 6545

www.jemachinetechn.com

8885 White Oak Ave #103, Rancho Cucamonga CA 91730



**JE MACHINE TECH**

**PS-223MLK9E**



Sizes (")	Weight(oz)
4	6.05
7	7.90
9	9.25
12	11.15
15	12.90
Available Colors	

# AR-15 M-LOK SUPER SLIM FREE FLOAT HANDGUARD

This JE Machine AR-15 handguard is designed to be free float. The minimalist design gives your AR-15 a slick, streamlined appearance. We have removed excess weight while retaining structural integrity.

This innovative handguard also includes an integrated anti-rotation tabs keeping the handguard secure and stable.



- Free float and lightweight design
- Fastened by 6 head screws
- Type III hard-coat anodized 6061-T6 aluminum
- Full picatinny rail on top
- M-Lok Compatible



- Steel barrel nut and all mounting hardware included
- 1.315" ID
- Anti-rotation tabs
- Available in 4"/7"/9"/12"/15"

(909) 972 6545

www.jemachinetechn.com

8885 White Oak Ave #103, Rancho Cucamonga CA 91730





**JE MACHINE TECH**



**PS-223MLK12E**



Sizes (")	Weight(oz)
4	6.05
7	7.90
9	9.25
12	11.15
15	12.90
Available Colors	

# AR-15 M-LOK SUPER SLIM FREE FLOAT HANDGUARD

This JE Machine AR-15 handguard is designed to be free float. The minimalist design gives your AR-15 a slick, streamlined appearance. We have removed excess weight while retaining structural integrity.

This innovative handguard also includes an integrated anti-rotation tabs keeping the handguard secure and stable.



- Free float and lightweight design
- Fastened by 6 head screws
- Type III hard-coat anodized 6061-T6 aluminum
- Full picatinny rail on top
- M-Lok Compatible



- Steel barrel nut and all mounting hardware included
- 1.315" ID
- Anti-rotation tabs
- Available in 4"/7"/9"/12"/15"

(909) 972 6545

www.jemachinetechn.com

8885 White Oak Ave #103, Rancho Cucamonga CA 91730



**JE MACHINE TECH**



**PS-223MLK15E**



Sizes (")	Weight(oz)
4	6.05
7	7.90
9	9.25
12	11.15
15	12.90
Available Colors	

# AR-15 M-LOK SUPER SLIM FREE FLOAT HANDGUARD

This JE Machine AR-15 handguard is designed to be free float. The minimalist design gives your AR-15 a slick, streamlined appearance. We have removed excess weight while retaining structural integrity.

This innovative handguard also includes an integrated anti-rotation tabs keeping the handguard secure and stable.



- ✔ Free float and lightweight design
- ✔ Fastened by 6 head screws
- ✔ Type III hard-coat anodized 6061-T6 aluminum
- ✔ Full picatinny rail on top
- ✔ M-Lok Compatible



- ✔ Steel barrel nut and all mounting hardware included
- ✔ 1.315" ID
- ✔ Anti-rotation tabs
- ✔ Available in 4"/7"/9"/12"/15"

(909) 972 6545

www.jemachinetechn.com

8885 White Oak Ave #103, Rancho Cucamonga CA 91730



**JE MACHINE TECH**

**PS-ST27B**



Available Colors



# SKELETONIZED PISTOL STABILIZER BLADE

The JE Machine AR-15 ultra-lightweight Skeletonized Pistol Stabilizer Blade is manufactured to exacting tolerance and fits pistol buffer tube. The stabilizer improves your marksmanship by providing additional support for your pistol when you operate your AR pistol with one hand.

The design incorporates a vertical fin, which you stabilize against the inside of your forearm when in the firing position. Install within minutes, just slip it on and tighten the large set screw for a rock-solid installation.



- ✔ Ultra-lightweight. Weighs a scant 4.8 oz
- ✔ Sloping cheek weld provides a contact surface for user comfort and stabilizing
- ✔ Securely lock it in place with a set screw



- ✔ Designed to fit any pistol buffer tube with a diameter up to 1.25"
- ✔ Forearm strap slots
- ✔ Impact-resistant, high-strength polymer
- ✔ Available colors: Black/Tan

(909) 972 6545

www.jemachinetech.us

8885 White Oak Ave #103, Rancho Cucamonga CA 91730



**JE MACHINE TECH**

**PS-ST7B**



Available Colors



# JE MACHINE AR-15 SOPMOD STOCK

The AR-15 SOPMOD stock was originally designed by the NSWC CRANE for the battlefield. This JE Machine SOPMOD stock provides excellent cheek comfort while allowing you to maintain optimum shooting position.

The rubber buttpad provides a no-slip surface against chest rigs and body armor while preventing the gun from moving. The built-in watertight battery storage allows you to store CR123A 3V lithium batteries or other small items such as earplugs.



- ✔ Sloping cheek weld provides a wide contact surface for user comfort
- ✔ Integrated quick detach sling swivel sockets on both sides
- ✔ Watertight battery storage for CR123A 3V lithium batteries



- ✔ Impact-resistant, high-strength polymer
- ✔ Fits Mil-Spec carbine buffer tubes
- ✔ CA compliant edition available

(909) 972 6545

www.jemachinetech.us

8885 White Oak Ave #103, Rancho Cucamonga CA 91730



**JE MACHINE TECH**

**PS-BTMCOMBO**



# BUFFER TUBE COMBO KIT

The JE Machine buffer tube combo kit includes the following components:



- ✓ Mil-Spec 6 position buffer tube
- ✓ 3 oz. buffer
- ✓ Carbine length buffer spring



- ✓ Regular end plate
- ✓ Castle nut

(909) 972 6545

www.jemachinetech.us

8885 White Oak Ave #103, Rancho Cucamonga CA 91730



**JE MACHINE TECH**

**PS-ST2B+PS-BTMCOMBO**



# JE MACHINE M4 STOCK BUFFER TUBE COMBO KIT

The JE Machine AR-15 buttstock and buffer tube combo includes the following components:



- ✓ M4 Collapsible Stock
- ✓ Mil-Spec 6 position buffer tube
- ✓ 3 oz. buffer



- ✓ Carbine length buffer spring
- ✓ Regular end plate
- ✓ Castle nut

(909) 972 6545

www.jemachinetech.us

8885 White Oak Ave #103, Rancho Cucamonga CA 91730



**JE MACHINE TECH**

**PS-223MLK7G**



Sizes (")	Weight(oz)
7	11.10
10	14.05
12	14.95
15	17.20
Available Colors	

# AR-15 M-LOK FREE FLOAT SLANT VERSATILE QUAD RAIL HANDGUARD

This JE Machine AR-15 handguard eliminates the top center rail for better grip and weight reduction. This innovative handguard also includes an integrated anti-rotation tabs keeping the handguard secure and stable.

The clamp-on system provides easy installation. 2 built-in quick disconnect sling sockets at the 3 and 9 o'clock positions



- ✔ Clamp on system, no timing required for easy installation
- ✔ Type III hard-coat anodized 6061-T6 aluminum
- ✔ Full Picatinny rail on top and fixed Picatinny rails at 3,6,9 o'clock positions near front
- ✔ M-Lok compatible



- ✔ Smooth middle for ergonomic grip
- ✔ 2 built-in QD sockets
- ✔ Anti-rotation tabs
- ✔ Steel barrel nut and all mounting hardware included
- ✔ 1.357" ID
- ✔ Available in 7"/10"/12"/15"

(909) 972 6545

www.jemachinetech.us

8885 White Oak Ave #103, Rancho Cucamonga CA 91730



**JE MACHINE TECH**

**PS-223MLK10G**



Sizes (")	Weight(oz)
7	11.10
10	14.05
12	14.95
15	17.20
Available Colors	

# AR-15 M-LOK FREE FLOAT SLANT VERSATILE QUAD RAIL HANDGUARD

This JE Machine AR-15 handguard eliminates the top center rail for better grip and weight reduction. This innovative handguard also includes an integrated anti-rotation tabs keeping the handguard secure and stable.

The clamp-on system provides easy installation. 2 built-in quick disconnect sling sockets at the 3 and 9 o'clock positions



- ✔ Clamp on system, no timing required for easy installation
- ✔ Type III hard-coat anodized 6061-T6 aluminum
- ✔ Full Picatinny rail on top and fixed Picatinny rails at 3,6,9 o'clock positions near front
- ✔ M-Lok compatible



- ✔ Smooth middle for ergonomic grip
- ✔ 2 built-in QD sockets
- ✔ Anti-rotation tabs
- ✔ Steel barrel nut and all mounting hardware included
- ✔ 1.357" ID
- ✔ Available in 7"/10"/12"/15"

(909) 972 6545

www.jemachinetech.us

8885 White Oak Ave #103, Rancho Cucamonga CA 91730





**JE MACHINE TECH**

**PS-223MLK12G**

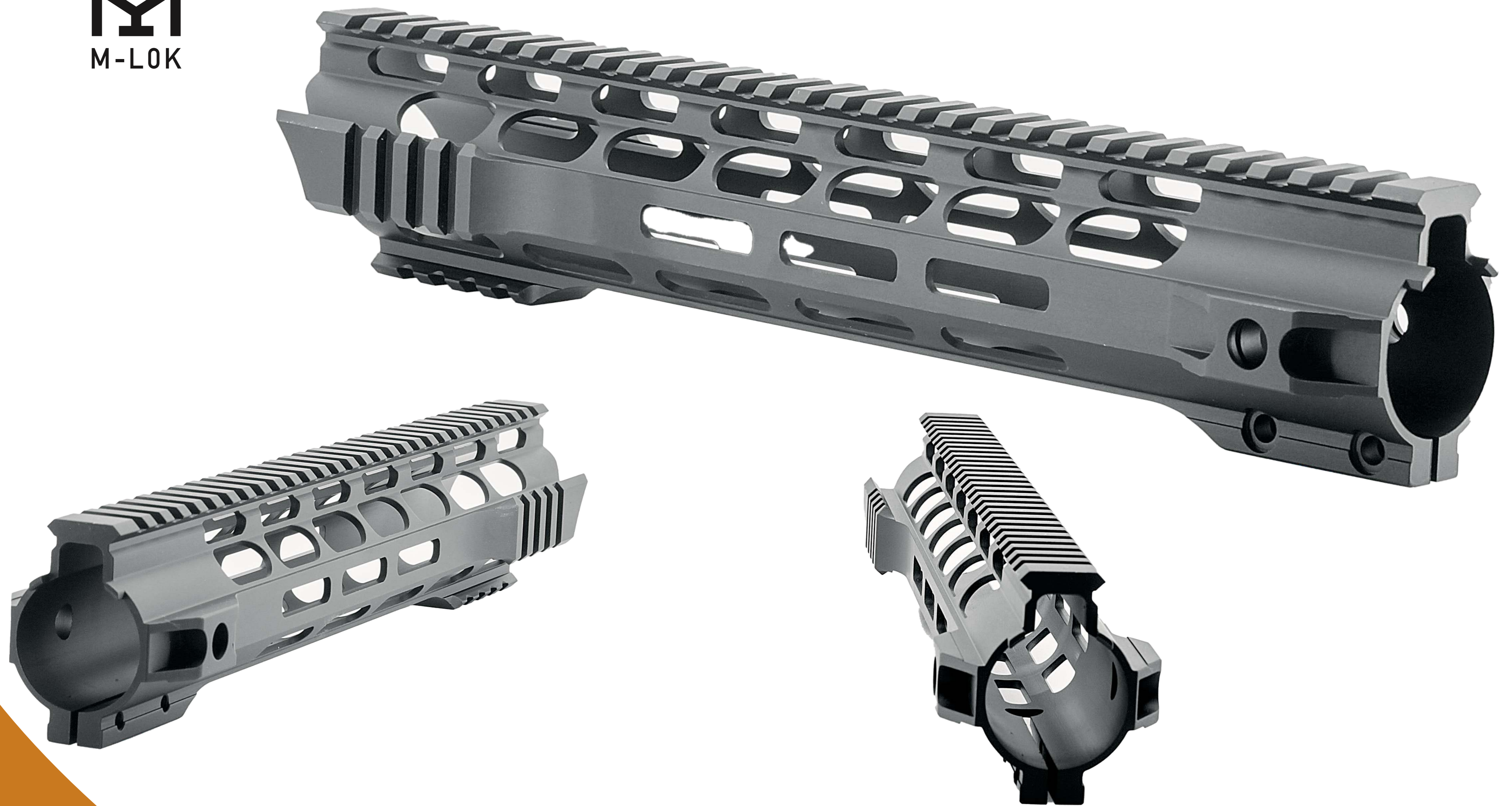

Sizes (")	Weight(oz)
7	11.10
10	14.05
12	14.95
15	17.20
Available Colors	

# AR-15 M-LOK FREE FLOAT SLANT VERSATILE QUAD RAIL HANDGUARD

This JE Machine AR-15 handguard eliminates the top center rail for better grip and weight reduction. This innovative handguard also includes an integrated anti-rotation tabs keeping the handguard secure and stable.

The clamp-on system provides easy installation. 2 built-in quick disconnect sling sockets at the 3 and 9 o'clock positions



- ✔ Clamp on system, no timing required for easy installation
- ✔ Type III hard-coat anodized 6061-T6 aluminum
- ✔ Full Picatinny rail on top and fixed Picatinny rails at 3,6,9 o'clock positions near front
- ✔ M-Lok compatible



- ✔ Smooth middle for ergonomic grip
- ✔ 2 built-in QD sockets
- ✔ Anti-rotation tabs
- ✔ Steel barrel nut and all mounting hardware included
- ✔ 1.357" ID
- ✔ Available in 7"/10"/12"/15"

(909) 972 6545

www.jemachinetech.us

8885 White Oak Ave #103, Rancho Cucamonga CA 91730



**JE MACHINE TECH**

**PS-ST7B+PS-BTMCOMBO**



# JE MACHINE SOPMOD STOCK BUFFER TUBE COMBO KIT

The JE Machine AR-15 buttstock and buffer tube combo includes the following:



- ✔ SOPMOD Collapsible Stock
- ✔ Mil-Spec 6 position buffer tube
- ✔ 3 oz. buffer



- ✔ Carbine length buffer spring
- ✔ Regular end plate
- ✔ Castle nut

(909) 972 6545

www.jemachinetech.us

8885 White Oak Ave #103, Rancho Cucamonga CA 91730



**JE MACHINE TECH**

**TS-ST28B**

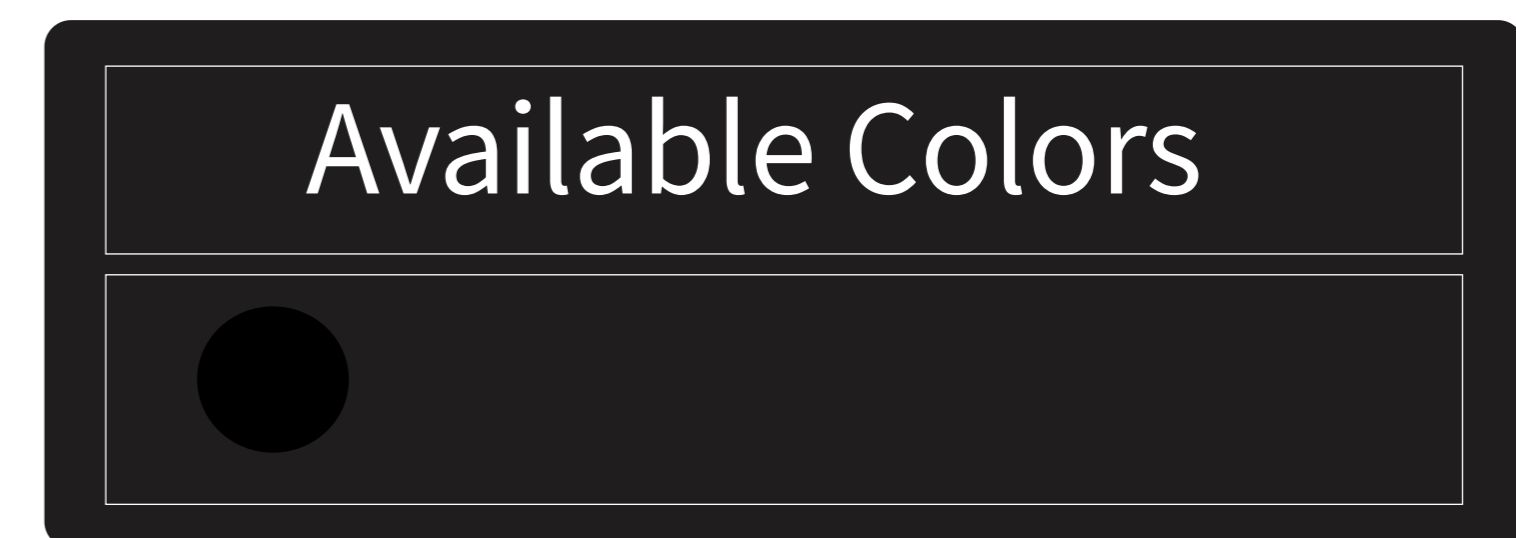

# ALUMINUM SKELETONIZED PISTOL STABILIZER BLADE

The JE Machine AR-15 skeletonized pistol stabilizer blade is built out of super light weight skeletonized aluminum construction.

This stylish brace comes with firearm strap slots and is designed to fit pistol buffer tubes with diameters of up to 1.25".



- ✔ Super lightweight skeletonized aluminum construction
- ✔ 2 piece kit includes the brace and fin
- ✔ 2 screw clamp system to hold to tube securely



- ✔ Includes 2 M-Lok slots and 2 QR release holes
- ✔ Designed to fit any pistol buffer tube with a diameter up to 1.25"
- ✔ Forearm strap slots

(909) 972 6545

www.jemachinetech.us

8885 White Oak Ave #103, Rancho Cucamonga CA 91730



**JE MACHINE TECH**

**TS-PS8B-AL**



# AR-15 FIXED 45 DEGREE BACK-UP IRON SIGHTS

The AR-15 fixed 45-degree back-up combat iron sights delivers maximum functionality and strength. The sight comes with dual aperture and the windage adjustable rear mounts on all 1913 Picatinny rails while providing reliable and precise positioning.



- ✔ Black anodized aircraft grade aluminum
- ✔ 45 degree fixed offset mount
- ✔ Precise windage & elevation adjustments



- ✔ Uses standard A2 sight post
- ✔ Rear sight contains multiple diameter apertures with windage adjustment for various applications
- ✔ Picatinny/Weaver-Style mount

(909) 972 6545

www.jemachinetech.us

8885 White Oak Ave #103, Rancho Cucamonga CA 91730



**JE MACHINE TECH**

**TS-PS9B-AL**

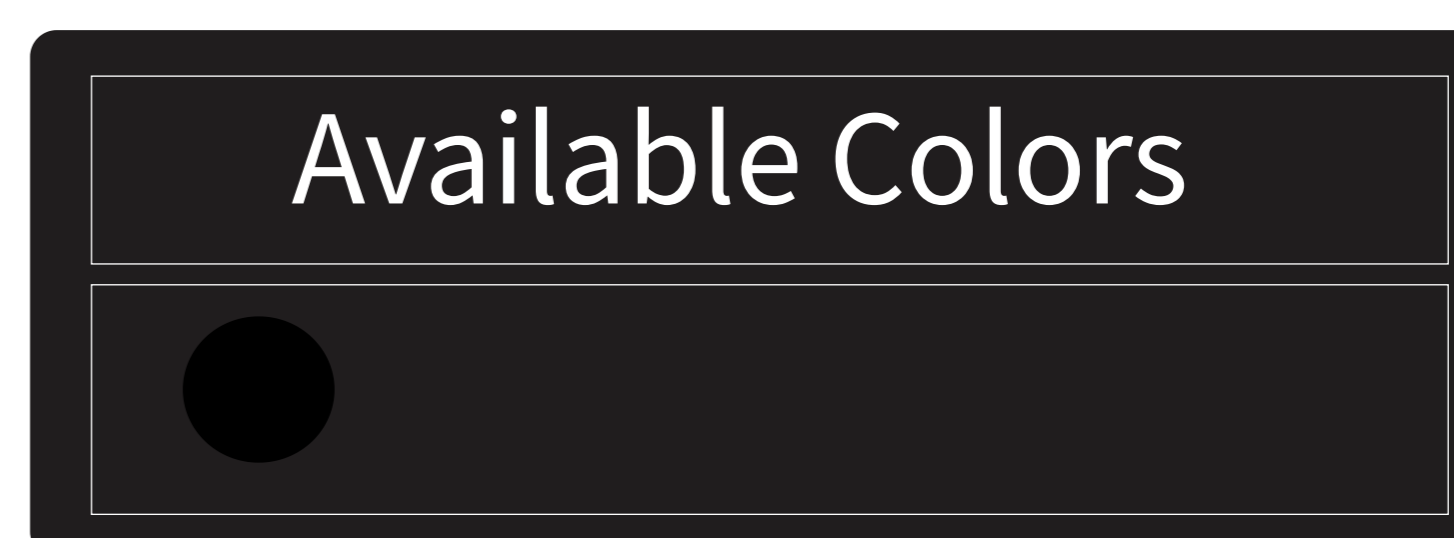
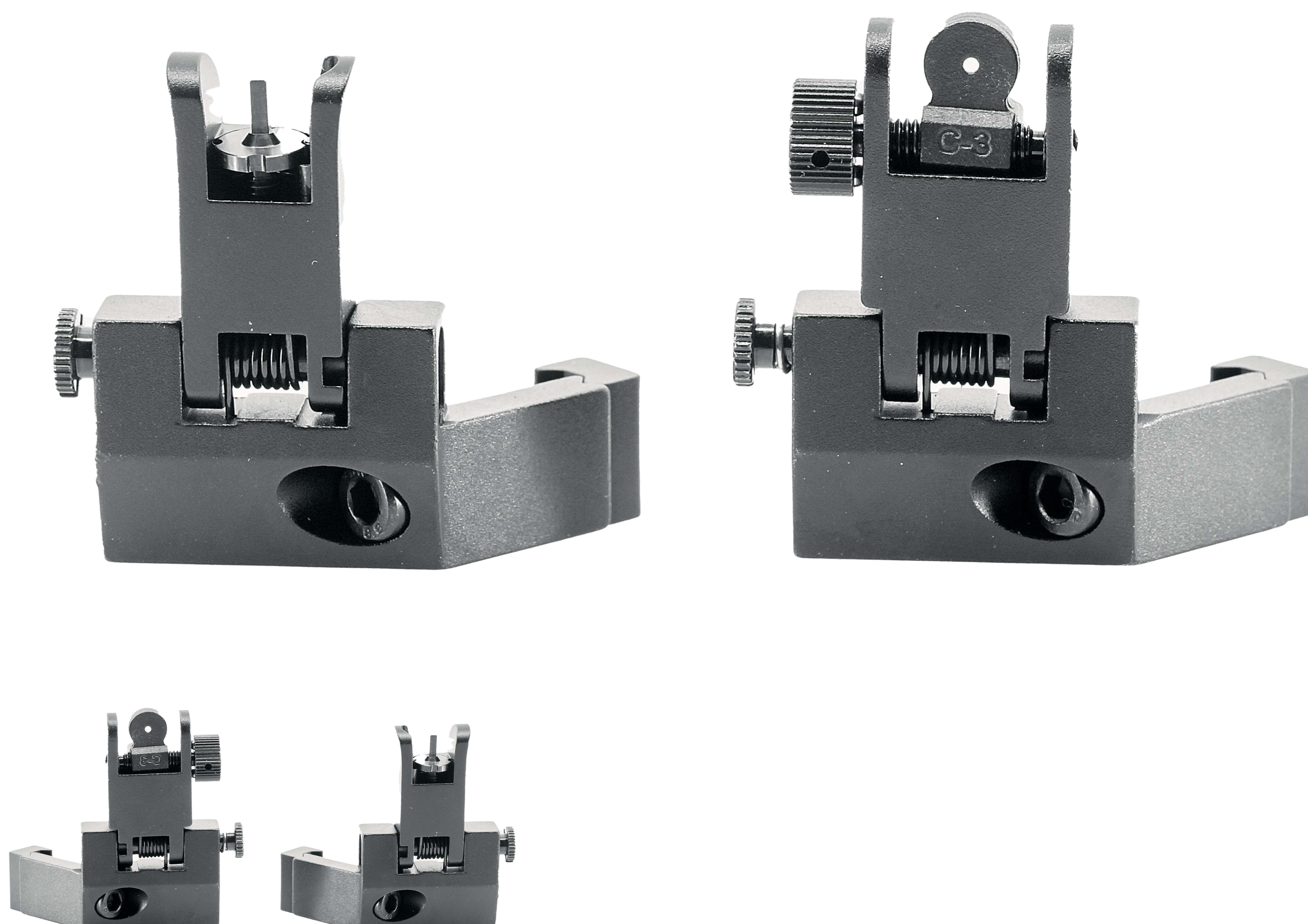

# AR-15 FLIP-UP 45 DEGREE BACK-UP IRON SIGHTS

This AR-15 flip-up 45-degree back-up iron sights delivers maximum functionality and strength. The sight comes with dual aperture and the windage adjustable rear mounts on all 1913 Picatinny rails while providing reliable and precise positioning.

The spring-loaded flip-up sights pop up instantly when activated by pushing the side button.



- ✔ Black anodized aircraft-grade aluminum 45 degree offset mount
- ✔ Spring loaded for quick deployment
- ✔ Precise windage adjustments
- ✔ Uses standard A2 sight post



- ✔ Rear sight contains multiple diameter apertures with windage adjustment for various applications
- ✔ Picatinny/Weaver-Style mount

(909) 972 6545

www.jemachinetech.us

8885 White Oak Ave #103, Rancho Cucamonga CA 91730



**JE MACHINE TECH**

**TS-PS25B**



Available Colors



# AR-15 FLIP-UP BACK-UP IRON SIGHTS

This AR-15 flip-up back-up iron sights deliver maximum functionality and strength. The sight comes with dual aperture and the windage adjustable rear mounts on all 1913 Picatinny rails while providing reliable and precise positioning



- ✔ Black anodized aircraft grade aluminum
- ✔ Ball bearing pivot detent
- ✔ Automatically locks into position when raised



- ✔ Quick detachable with adjustable A2 square post
- ✔ Uses standard A2 sight post
- ✔ Same plane hand guard / upper receiver height

(909) 972 6545

www.jemachinetech.us

8885 White Oak Ave #103, Rancho Cucamonga CA 91730



**JE MACHINE TECH**

**PS-PG5B**

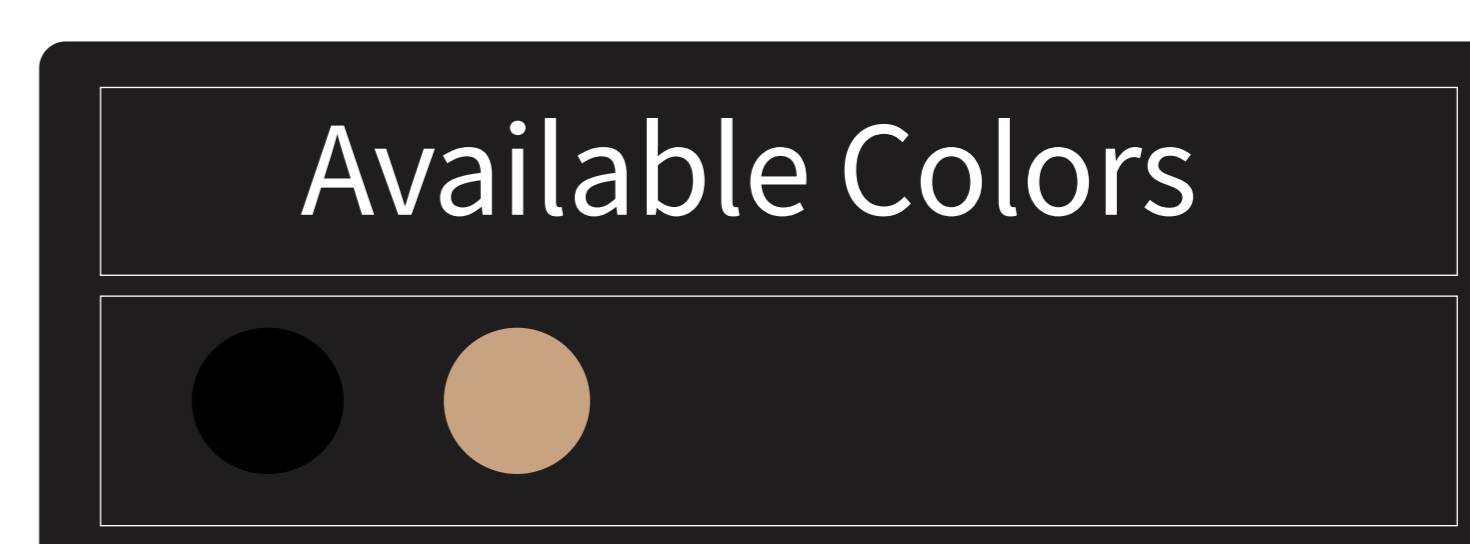

# TITAN AR PISTOL GRIP

The JE Machine Titan AR-15 pistol grip is designed to provide maximum handgrip which improves trigger control and shooting comfort. Ergonomically designed for maximum gripping power and comfort.

The palm swell, right thumb rest and finger grooves ensure proper hand placement for excellent trigger control.



- ✔ High quality injected molded polymer
- ✔ Heavy duty grip
- ✔ Ergonomically designed for maximum gripping power and comfort



- ✔ Built in finger grooves for a solid grip
- ✔ Easy to install by replacing the stock grip. No gunsmithing required
- ✔ Available colors: Black/Tan

(909) 972 6545

www.jemachinetech.us

8885 White Oak Ave #103, Rancho Cucamonga CA 91730



**JE MACHINE TECH**

**PS-PG2B**



Available Colors



# AR ERGONOMIC PISTOL GRIP

This JE Machine AR-15/AR-10 pistol grip is molded from durable hard polymer that comfortably fits the shooter's hand. The entire contact point is textured to provide excellent weapon control.

The built-in storage allows you to store CR123A 3V lithium batteries or other small items such as ear plugs.

- ✔ Impact-resistant, high-strength polymer
- ✔ Ergonomic non-slip design
- ✔ Integrated extended beavertail provides better control during firing
- ✔ Hinged door in bottom of grip for quick access to the storage

- ✔ Easy to install by replacing the stock grip. No gunsmithing require
- ✔ CA compliant edition available
- ✔ Available colors: Black/Tan

(909) 972 6545

www.jemachinetech.us

8885 White Oak Ave #103, Rancho Cucamonga CA 91730







**JE MACHINE TECH**

**PS-ST32B**



Available Colors



# JE MACHINE ADAPTIVE SKELETONIZED AR-15 BUTTSTOCK

The JE Machine Adaptive Skeletonized AR-15 buttstock features a strong and robust design and is constructed from high impact-resistant polymer.

This stock comes with QD sockets in the front and the rear, and includes an ambidextrous release latch which provides you the ability to operate your AR-15 effectively with either hand based on your preference.



- ✔ Strong and robust design
- ✔ Impact-resistant, high-strength polymer
- ✔ Two QD sockets, one in the front and one at the rear
- ✔ Fits Mil-Spec carbine buffer tubes



- ✔ CA compliant edition available
- ✔ Available colors: Black/Tan
- ✔ Made in U.S.A

(909) 972 6545

www.jemachinetech.us

8885 White Oak Ave #103, Rancho Cucamonga CA 91730