



GUIL®

Desde 1983

GARRAS Y ABRAZADERAS CABRESTANTES Y POLIPASTOS



GF-01

Gancho de acero reforzado para focos con plancha protectora





 0,42 kg
 SWL 75 kg \varnothing 30 - 50  30 x 7 mm
 T M10 x 50 mm



GF-03

Gancho de acero reforzado para focos con plancha protectora (grandes cargas)



 1,05 kg \varnothing 30 - 60 mm  40 x 10 mm
 SWL 200 kg  T M16 x 60 mm



GF-06

Gancho de aluminio para teatro

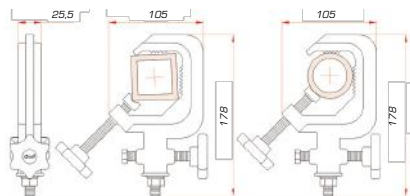



 0,48 kg \varnothing 28 - 50 mm
 SWL 50 kg \square 28 - 50 mm



Garra de aluminio para focos de teatro para cargas de hasta 50 kg. Provista de doble cierre de seguridad: mediante pomo de fijación y tornillo de presión.

Su especial diseño permite la fijación de tubos redondos y cuadrados con diámetro externo desde 28 mm a 50 mm.

 25 x 23 mm
 T M10 x 50 mm





ABZ-38

Abrazadera de aluminio para cargas ligeras y tubos de pequeño diámetro.

Nuestra abrazadera ABZ-38 incluye tornillo y tuerca de mariposa para la sujeción de focos, equipos electrónicos y otros dispositivos de hasta 30 kg.

Especialmente indicada para instalaciones sencillas y ligeras, nuestra abrazadera ref. ABZ-38 está diseñada para una fijación segura a trusses / tubos con diámetro externo desde 35 a 40 mm.



 0,11 kg \varnothing 35 - 40 mm  56 x 30 mm
 SWL 30 kg  T M 08 x 35 mm

ABZ-60

La bisagra para garras y abrazaderas, permite ahorrar espacio a la hora de almacenar y transportar efectos de iluminación, cabezas robóticas y todos aquellos aparatos susceptibles de montar una garra o abrazadera para su utilización.

Nuestra práctica bisagra ref. ABZ-60 permite guardar un aparato electrónico en un flight case sin tener que desmontar la garra y de esta manera se ahorra tiempo al no tener que montar la garra cada vez que se tiene que hacer un evento.

Ahorra tiempo y espacio de almacenaje gracias a nuestra bisagra para garras ref. ABZ-60.



 75 kg  50 x 50 mm
 SWL 0,40 kg

ABZ-53/N

Abrazadera de aluminio con tornillería

- 📦 0,17 kg
- SWL 100 kg
- ∅ 48-51 mm
- 🔩 M10 x 30

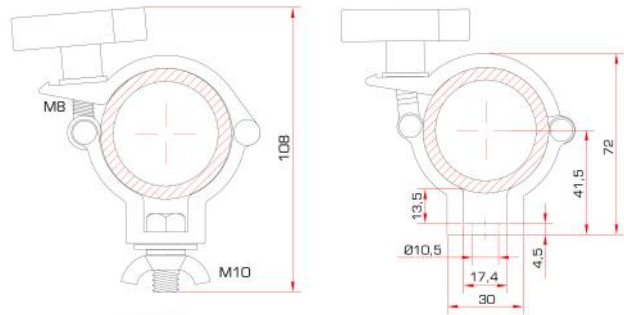

ABZ-58/N

Abrazadera de aluminio con argolla

- 📦 0,23 kg
- SWL 100 kg
- ∅ 48-51 mm
- 🔩 M8



ABZ-21/N

Abrazadera doble giratoria

- 📦 0,24 kg
- SWL 100 kg
- ∅ 48-51 mm

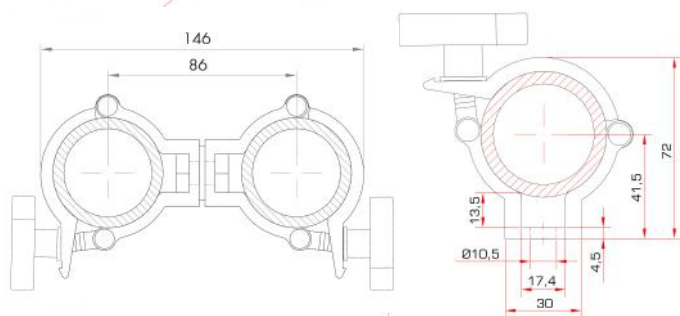

ABZ-01

Garra de anclaje rápido de aluminio

- 📦 0,39 kg
- SWL 100 kg
- ∅ 50-51 mm

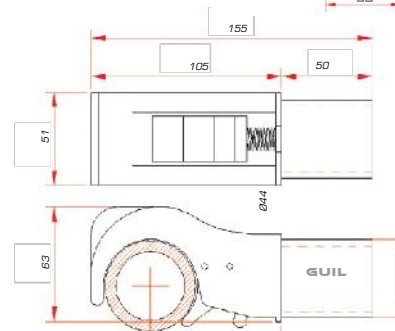

ABZ-54/N

Garra de anclaje rápido de aluminio

- 📦 0,39 kg
- SWL 100 kg
- ∅ 50-51 mm

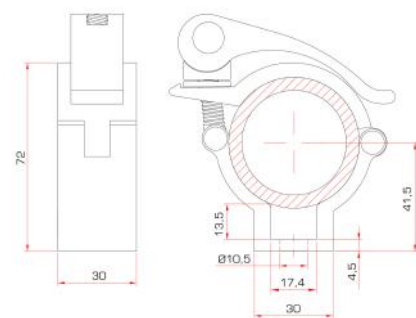

ABZ-16

Abrazadera de aluminio (∅ 29 mm)

- 📦 1,13 kg
- SWL 300 kg
- ∅ 18-80 mm / 20 x 20 mm a 70 x 70mm
- 🔩 A: M14 x 115 / B:

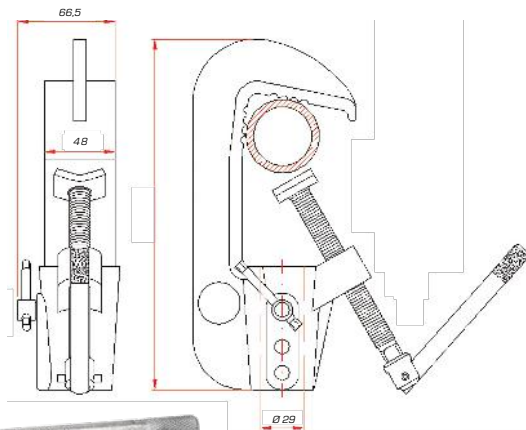

ABZ-02

Abrazadera de aluminio

- 📖 0,55 kg
- SWL 250kg
- ∅ 45-52 mm

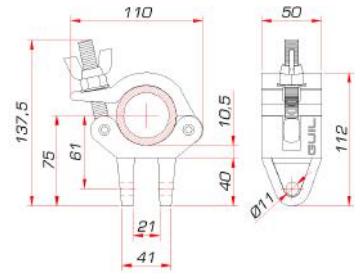

ABZ-23

Abrazadera con macho de aluminio

- 📖 1,00 kg
- SWL 250 kg
- ∅ 45-52 mm

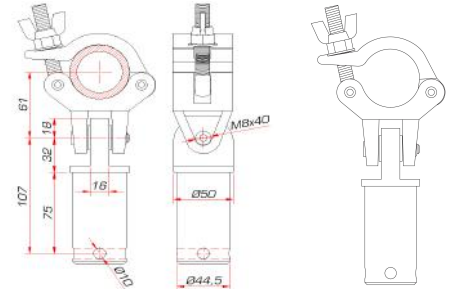

ABZ-24

Abrazadera de aluminio

- 📖 0,63 kg
- SWL 750 kg
- ∅ 45-52 mm

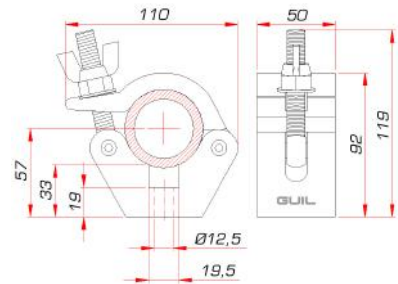

ABZ-03

Abrazadera con tornillería

- 📖 0,86 kg
- SWL 500 kg
- ∅ 45-52 mm
- T M12 x 50

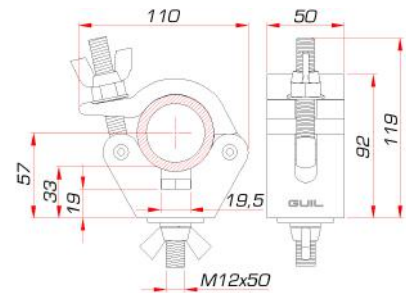

ABZ-04

Abrazadera con argolla

- 📖 0,84kg
- SWL 340 kg
- ∅ 45-52 mm
- ⊙ M12

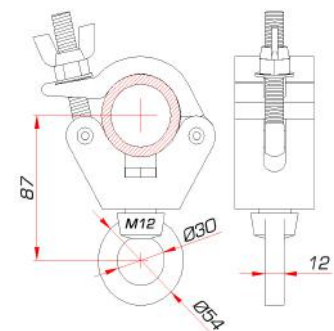

ABZ-05



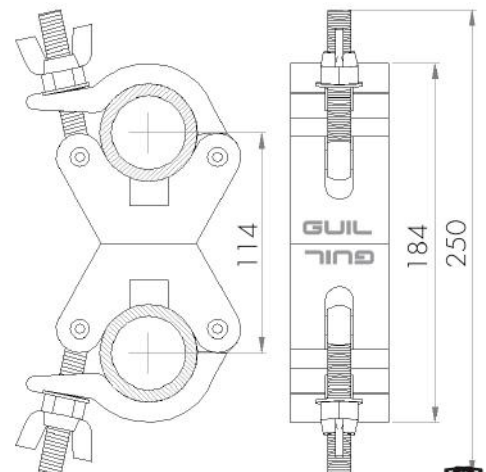

Abrazadera doble giratoria (360°)

- 📖 1,33 kg
- SWL 750 kg
- ∅ 45-52 mm



ABZ-35/N

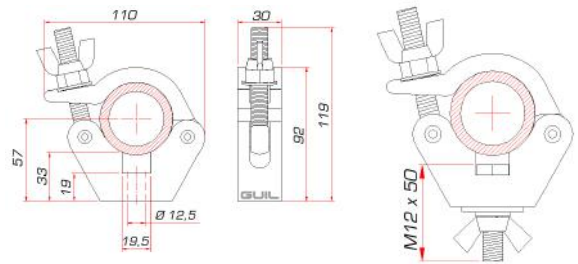

Abrazadera de aluminio

-  0,50 kg
-  SWL 500 kg
-  Ø 45-52 mm
-  T M12X50



ABZ-29/N

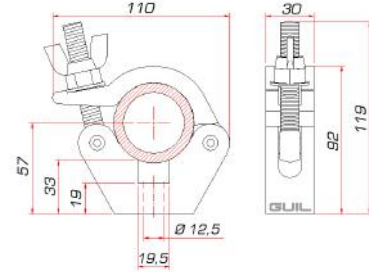

Abrazadera de aluminio

-  0,40 kg
-  SWL 500 kg
-  Ø 45-52 mm



ABZ-03/R

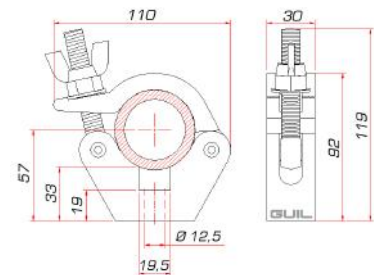

Abrazadera de aluminio con rueda

-  1,43 kg
-  SWL 100 kg
-  Ø 45-52 mm



ABZ-30/N

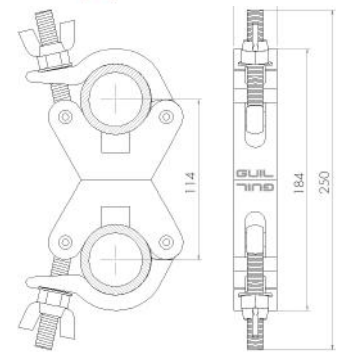

Abrazadera doble giratoria 360° de aluminio

-  0,86 kg
-  SWL 500 kg
-  Ø 45-52 mm



ABZ-31

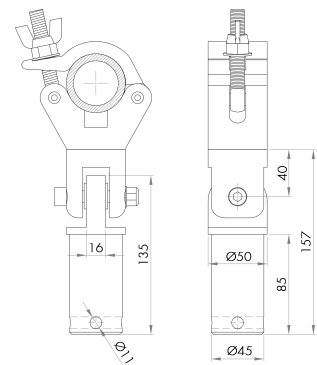

Abrazadera con macho macizo de aluminio

-  2,30 kg
-  SWL 750 kg
-  Ø 45-52 mm



ABZ-32



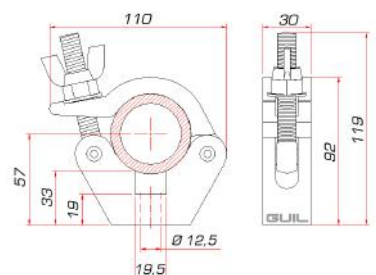

Doble abrazadera bisagra de aluminio

-  1,75kg
-  SWL 750 kg
-  Ø 45-52 mm



ABZ-34/N



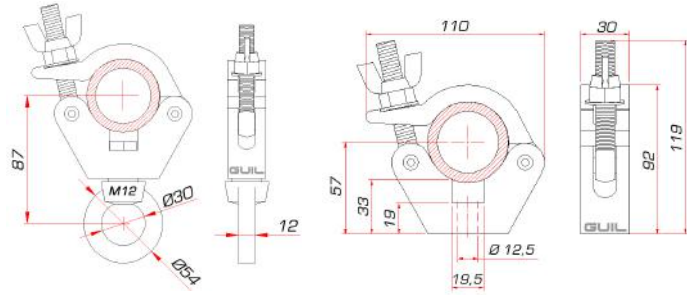

Abrazadera de aluminio con

-  0,60 kg
-  SWL 300 kg
-  \varnothing 45-52 mm
-  M12



ABZ-35/N

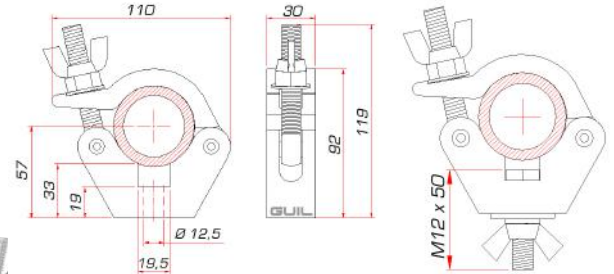

Abrazadera de aluminio

-  0,48 kg
-  SWL 500 kg
-  \varnothing 45-52
-  T M12 x 50



ABZ-37



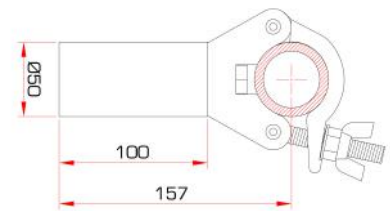

Abrazadera de aluminio con adaptador de 50mm

-  1,20 kg
-  SWL 500 kg
-  \varnothing 45-52 mm



ABZ-51/N



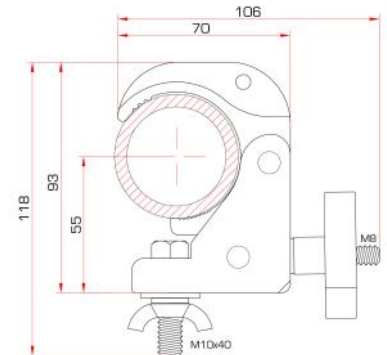

Abrazadera mini de aluminio de anclaje rápido

-  0,30 kg
-  SWL 100 kg
-  \varnothing 48-51 mm
-  T M10 x 40



ABZ-07/E-N

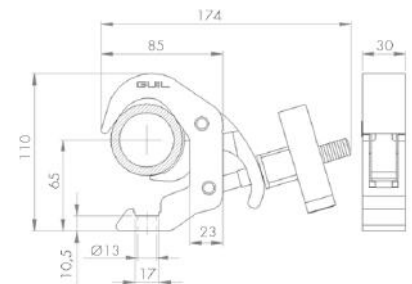

Abrazadera aluminio de anclaje rápido

-  0,54kg
-  SWL 100 kg
-  \varnothing 38-51 mm
-  T M10 x 35



ABZ-55



Garra de acero para carpas para colocar sonido e iluminación

-  0,49 kg
-  SWL 50 kg
- \varnothing 80-110 mm
-  T M10 x 35



Garra de acero para carpas con abrazadera para fijar trusses y tubos

ABZ-56

-  0,84 kg
-  SWL 50 kg
- \varnothing 45-52 mm
- \varnothing 80-110 mm



BULL200D



Cabrestante auto frenable (dos palancas)

- Capacidad de elevación 275 Kg.
- Capacidad de arrastre 550 Kg.

BULL300D



Cabrestante auto frenable (dos palancas)

- Capacidad de elevación 400 Kg.
- Capacidad de arrastre 800 Kg.

BULL400D



Cabrestante auto frenable (dos palancas)

- Capacidad de elevación 590 Kg.
- Capacidad de arrastre 1180 Kg.

BULL500D



Cabrestante auto frenable (dos palancas)

- Capacidad de elevación 650 Kg.
- Capacidad de arrastre 1495 Kg.



POLIPASTOS DE CADENA

POLI-10



8 M - 1000 KG

POLI-11



10 M - 1000 KG

POLI-12



6 M - 2000 KG

BLC-01

BOLSA PORTA CADENAS DE NYLON CON DOBLE ASA

Diseño reforzado con base de apoyo

- Altura Interna: 32 cm
- Carga Máxima: 35 Kg
- Base: Ø 25 cm
- Peso Neto: 0,78 kg



BLC-05

BOLSA PORTA CADENAS DE NYLON CON DOBLE ASA

Diseño reforzado con base de apoyo

- Altura Interna: 53 cm
- Carga Máxima: 35 Kg
- Base: Ø 25 cm
- Peso Neto: 1 kg

