

# **CLASSEN**<sup>®</sup>

## **DOOR** **CATALOGUE**



**2021**

**Hard Edge PF door leaf profile PF**

Rounded edge of the door leaf with a radius of 4mm, finished with elastic CPL laminates, obtained thanks to modern technology - postforming. Characteristic features - abrasion resistance and safety.

**Classen Primo**

Basic group of woodgrain veneer, impregnated, characterised by a required high scratch resistance.

**Hard Edge K door leaf profile**

Widely used, aesthetically executed edge with K rebate profile is a standard finishing of a door leaf. K edge profile is stylish and always in fashion.

**Classen 3D Look**

Veneers with synchronous pores effect. The pores synchronized with the woodgrain pattern optically emboss it, which leads to creation of a three-dimensional effect. These decors perfectly imitate natural veneer.

**Hard Edge R door leaf profile**

Aesthetically rounded edge with a 5 mm radius. Practical the solution guarantees greater security, e.g. of ours children as well as easier care.

**Classen Iridium**

A very high scratch and wear resistant laminate, consists of few layers of paper which undergo the process of hot press lamination with the use of special glues, covered with scratch resistant overlay lacquer. Its main advantage is a particularly high: scratch and wear, UV and chemical agents resistance as well as high aesthetic value due to maintaining the structure of the woodgrain.

**Hard Edge B door leaf profile**

Aesthetically executed, practical and always in fashion. This solution raises aesthetic value of the product and guarantees its quality and durability.

**Classen CPL**

A very high scratch and wear resistant laminate, created in the process of hot press lamination with the use of special glues, covered with scratch resistant overlay lacquer. Its main advantage is a particularly high: scratch and wear, high temperature, chemical and UV resistance.

**Lacquered HDF board**

Derivative wood product, characterised by high density, covered on one side with specialized ecological lacquer.

**Classen HPL**

Decorative laminate, 0.8 mm thick, based on thermosetting resin. It is created of several layers, which are composed of melamine decorative papers and with one or more reinforcing paper impregnated with resin. Additional use of special finishing layers and technological parameters determines the quality of the laminate and the scope of its applications. Laminates with such structure are characterized by a very high resistance to both chemical agents and mechanical damage.

**Classen LAK PU**

Smooth HDF surface coated with polyurethane varnish. Standard white Lac colour is an equivalent of RAL 9003. Quality used in RAL colours.

**Frame construction**

It consists of single elements, made entirely from wood-based material - MDF, veneered with Classen decors, joined together with the use of solid assembly dowels.

**Classen LAK UV, UV Pure**

Smooth HDF surface, covered with ecological UV cured varnish. Standard White Lac colour is an equivalent of RAL 9003.

**Honeycomb**

Highly specialized cardboard with a construction and structure similar to honeycomb, used as a standard stabilizing filling between construction / peripheral frame of a door leaf.

**Perforated chipboard**

Construction consisting of derivative wood perforated chipboard placed between peripheral frames made of softwood. Such construction of a door leaf guarantees high stability and increased sound absorption.

**HLT chipboard, acoustic**

A construction consisting of full chipboard with increased acoustic parameters, placed between a peripheral frame made of softwood and plywood.

**Chipboard**

A construction consisting of full chipboard, placed between peripheral frame made of softwood and a plywood. Such construction of a door leaf guarantees a high stability and very good sound absorption.

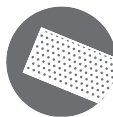
**Acoustic resistance**

Doors with increased acoustic resistance. Guarantee of full comfort and freedom of action.

**Classen Hard**

Reinforced peripheral frame, consisting of two construction elements: Peripheral frame made of softwood and derivative wood board, filled with highly specialized cardboard. This solution guarantees increased rigidity of a door leaf and resistance against warping.

**RAL colours**

Possibility of finishing the door in RAL colours for additional payment. Table of charges on page 142. Minimum order quantity - 3 sets (door leaf + frame). All collections in RAL are finished in polyurethane varnish quality.

**Anti-burglary door**

Internal entrance door, fulfilling the requirements of RC2 class anti-burglary protection, provide better security for your flat.

**EI 30**

Fire door designed for use as internal entrance doors in residential housing, public utility and collective residential buildings. Thickness of a door leaf - 50 mm.

**EI 60**

Fire door designed for use as internal entrance door in residential housing, public utility and collective residential buildings. Thickness of a door leaf 60 mm.

# CONTENTS

## LACQUERED DOORS 4

▪ Brenta <b>NEW</b>	6
▪ Venis	8
▪ Diamond	10
▪ Larix	12
▪ Linea	14
▪ Linea Premium	16
▪ Linea Premium Loft <b>NEW</b>	18
▪ Morano <b>NEW MODEL</b>	20
▪ Grafen	22
▪ Salvano	24
▪ Classic	26

## FRAMED DOORS 28

▪ Clif <b>NEW</b>	30
▪ Magnetic	32
▪ Greco	34
▪ Traffic	36
▪ Havana	38
▪ Lukka	40
▪ Tosca	42
▪ Ferro	44
▪ Kofano	46
▪ Antica	48

## VENEER PANEL DOORS 50

▪ Saga	52
▪ Asteria NL	54
▪ Asteria	56
▪ Discovery	58
▪ Tetyda	60
▪ Natura HR	62
▪ Andromeda	64
▪ Demeter	66
▪ Arena	68
▪ Century	70
▪ Malaga	72
▪ Modena 4	74
▪ Natura	76
▪ Antiope	78
▪ Ksantos New	80
▪ Temida	82

## TECHNICAL DOORS 84

▪ Natura HK CPL / HB CPL	86
▪ Natura HK HPL / HB HPL	88
▪ Guard	90
▪ Bord	92
▪ Bord W3	94
▪ Fire door EI30 42dB	96
▪ Fire door EI30 / EI60	98
▪ Venom	100
▪ Venom Alu	102
▪ Acoustic Doors	104

## DOORS ALIGNED WITH THE WALL 106

▪ Compact system	108
------------------	-----

## SLIDING DOORS 110

▪ Double leaf system	112
▪ Single leaf system	113
▪ Diva system	114
▪ DESIGN single leaf system	116

## EXTENSIONS - PASSIVE DOOR LEAF 118

▪ Extensions	118
--------------	-----

## WOOD-BASED DOOR FRAMES 119

▪ Adjustable	120
▪ Adjustable 80	120
▪ Adjustable non-rebated	121
▪ Adjustable non-rebated 80	121
▪ New Arcus	122
▪ Arcus	123
▪ Standard 2 pack	124
▪ Cmok	125
▪ HYBRID	126

## STEEL DOOR FRAMES

▪ Steel adjustable	127
▪ Steel adjustable non-rebated	128
▪ Steel fixed	129
▪ Steel fixed non-rebated	129

## DEDICATED DOOR FRAMES

▪ BORD steel corner	130
▪ BORD steel fixed	131
▪ BORD MDF	132
▪ BORD steel fixed	133
▪ Guard steel fixed	134
▪ Guard steel adjustable	134
▪ Fire wooden	135
▪ Fire steel fixed	135
▪ Fixed MDF 42 dB	136
▪ Fixed non-rebated MDF 42dB	136

## ACCESSORIES AND DIMENSIONS

▪ ABC of doors - information base	138
▪ Additional accessories	142
▪ RAL colours	142
▪ Crowns and overlay mouldings	143
▪ Accessories	144
▪ Handles	146
▪ Classen decors	150
▪ CPL / HPL UNI Decors	152
▪ CPL / HPL Woodgrain Decors	153

minimalism and elegance  
FOR A COLOUR TO BE BROKEN



# LACQUERED DOORS

A perfect combination of modern design and high quality workmanship. A real treat for perfectionists. In our collections, they most often appear in the colour of timeless white, which makes them a great means to enlarge the interior optically. The minimalism of decorations gives them an elegant character. The surface of the leaves finished with varnish is perfectly smooth. Aesthetics go hand in hand with usability. The doors are easy to clean and care. They are also distinguished by high durability and resistance to damage, so they become a good investment for years.



**DO YOU LOVE VIVID COLOURS?**  
Do you feel that they express your personality? Don't give up on them! C doors will harmonize beautifully with even the craziest palette of colours, while introducing balance in the interior design.

**DO YOU PREFER SIMPLICITY AND MONOCHROMATIC COLOURS?**  
You will find them in lackquered doors with a minimalist design. Thanks to them you will emphasize the elegant and subdued character of your apartment.

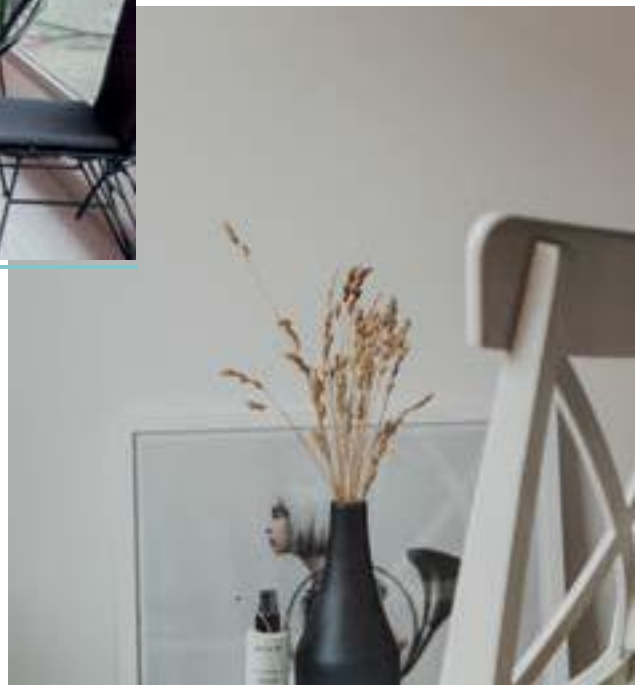

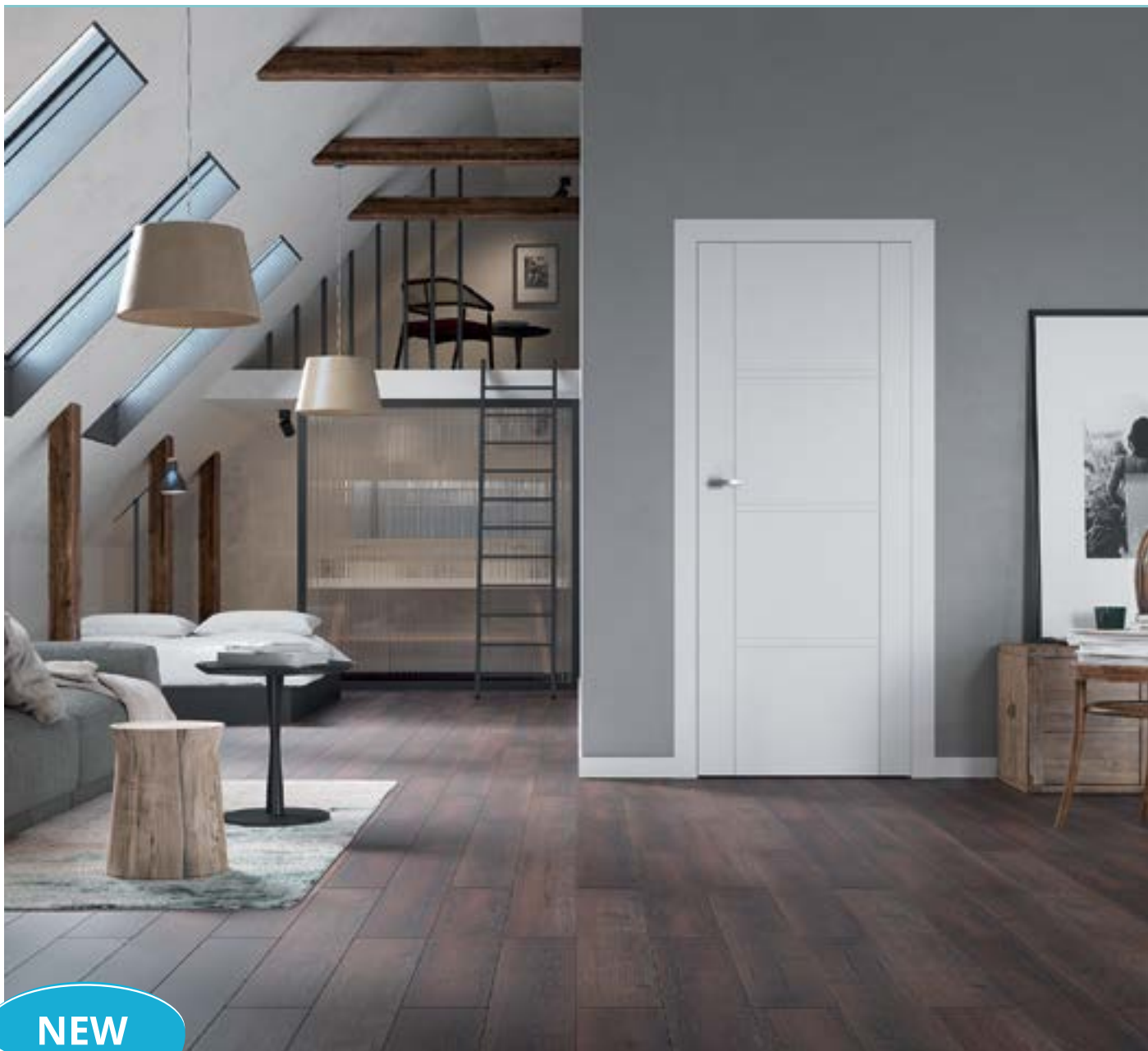

floor: Classen L3793

NEW

## BRENTA

### EXECUTION STANDARD

- lacquered door leaf, rebated or non-rebated
- finishing: UV Pure lacquer, smooth surface
- **Rebated door leaf construction:**
  - Hard Edge K door edge profile
  - stabilizing honeycomb insert, peripheral frame made of softwood
  - two silver screwed pintle hinges (leaves 100' – 3 hinges, leaves reinforced, regardless of size – 3 hinges)
  - lock for regular key, bathroom key, cylinder lock, mortise lock
  - single leaf 60' - 100'
  - double leaf 120'-200'
  - sliding single and double leaf doors
- **Non-rebated B door leaf construction:**
  - construction: Classen Hard/peripheral frame made of softwood
  - Hard Edge B door leaf edge profile
  - two openings for 3D hidden hinges for non-rebated door
  - magnetic lock: mortise lock, standard key lock, bathroom lock, cylinder lock
  - single leaf 60' - 100'

### OPTIONS FOR ADDITIONAL PAYMENT

#### VENTILATION

- ventilation undercut
- ventilation undercut 15mm (recuperation)
- ventilation sleeves (available in white only)

#### CONSTRUCTION

- third hinge
- perforated chipboard (rebated and non-rebated B)
- non-rebated door leaf (B)
- door leaf 100': + **20%**

### DOOR FRAMES

#### HARD EDGE K:

- UV wood derivative door frame

#### HARD EDGE B:

- UV lacquered adjustable non-rebated door frame





m. 1



m. 2



m. 3



m. 4



m. 5



m. 6



m. 7



Cutter shape

**Lacquered**



White UV Pure





Listwy nakładkowa: Classen LN2, floor: Classen Villa 4V Gloria 47207

## VENIS

### EXECUTION STANDARD

- lacquered door leaf, rebated or non-rebated
- finishing: UV Pure lacquer, smooth surface
- **Rebated door leaf construction:**
  - Hard Edge K door edge profile
  - stabilizing honeycomb insert, peripheral frame made of softwood
  - two silver screwed pintle hinges (leaves 100' – 3 hinges, leaves reinforced, regardless of size – 3 hinges)
  - lock for regular key, bathroom key, cylinder lock, mortise lock
  - single leaf 60'- 100'
  - double leaf 120'-200'
  - sliding single and double leaf doors
- **Non-rebated B door leaf construction:**
  - construction: Classen Hard/peripheral frame made of softwood
  - Hard Edge B door leaf edge profile
  - two openings for 3D hidden hinges for non-rebated door
  - magnetic lock: mortise lock, standard key lock, bathroom lock, cylinder lock
  - single leaf 60'- 100'

### OPTIONS FOR ADDITIONAL PAYMENT

#### VENTILATION

- ventilation undercut
- ventilation undercut 15mm (recuperation)
- ventilation sleeves (available in white only)

#### CONSTRUCTION

- third hinge
- perforated chipboard (rebated and non-rebated B)
- non-rebated door leaf (B)
- door leaf 100': + **20%**

### DOOR FRAMES

#### HARD EDGE K:

- UV wood derivative door frame

#### HARD EDGE B:

- UV lacquered adjustable non-rebated door frame







m. 1



m. 2



m. 3



m. 4

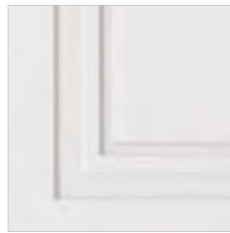

Cutter shape



Frame profile



Safety glass, toughened, white with application

**Lacquered**



White UV Pure





## DIAMOND

### EXECUTION STANDARD

- lacquered door leaf, rebated or non-rebated
- finishing: PU white lacquer, smooth surface
- overprint: painted glass, chamfered, black or grey
- Rebated door leaf construction:**
  - Hard Edge K door edge profile
  - stabilizing insert - lightweight board, peripheral frame made of softwood
  - 3 silver screwed pintle hinges
  - lock for regular key, bathroom key, cylinder lock, mortise lock
  - single leaf 60' - 100'
  - double leaf 120' - 200'
  - sliding single and double leaf doors
- Non-rebated B door leaf construction:**
  - Hard Edge B door leaf edge profile
  - two openings for 3D hidden hinges for non-rebated door
  - magnetic lock: mortise lock, standard key lock, bathroom lock, cylinder lock
  - single leaf 60' - 100'

### OPTIONS FOR ADDITIONAL PAYMENT

#### VENTILATION

- ventilation undercut
- ventilation undercut 15mm (recuperation)

#### CONSTRUCTION

- non-rebated door leaf (B)
- door leaf 100': + **20%**

### DOOR FRAMES

#### HARD EDGE K:

- PU wood derivative door frame

#### HARD EDGE B:

- PU lacquered adjustable non-rebated door frame





m. 1



m. 2



m. 3



m. 4



m. 5



m. 6



Painted glass,  
chamfered, black



Painted glass,  
chamfered, grey

**Lacquered**

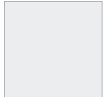

White PU



## LARIX

### EXECUTION STANDARD

- lacquered door leaf, rebated or non-rebated
- finishing: UV Pure lacquer, smooth surface
- Rebated door leaf construction:**
  - Hard Edge K door edge profile
  - peripheral frame made of softwood, filling - perforated chipboard
  - 3 silver screwed pintle hinges
  - lock for regular key, bathroom key, cylinder lock, mortise lock
  - single leaf 60'- 100'
  - double leaf 120'-200'
  - sliding single and double leaf doors
- Non-rebated B door leaf construction:**
  - Hard Edge B door leaf edge profile
  - two openings for 3D hidden hinges for non-rebated door
  - magnetic lock: mortise lock, standard key lock, bathroom lock, cylinder lock
  - single leaf 60'- 100'

### OPTIONS FOR ADDITIONAL PAYMENT

#### VENTILATION

- ventilation undercut
- ventilation undercut 15mm (recuperation)
- ventilation sleeves (available in white only)

#### CONSTRUCTION

- non-rebated door leaf (B)
- door leaf 100': + **20%**

### DOOR FRAMES

#### HARD EDGE K:

- UV wood derivative door frame

#### HARD EDGE B:

- UV lacquered adjustable non-rebated door frame





m. 1



m. 2



m. 3



m. 4



m. 5



m. 6



m. 7

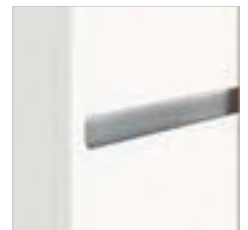

Aluminium profile \*)

\*) Aluminium profile, width: 8mm (colour - stainless steel / INOX), aligned with a door leaf surface.

**Lacquered**



White UV Pure





## LINEA

### EXECUTION STANDARD

- lacquered door leaf, rebated or non-rebated
- finishing: water-based UV cured White varnish, smooth surface
- satin glass, Decormat (except for model 1.2 - toughened glass, white, with horizontal, transparent strips)
- glazing beads veneered with PR - White decor

#### Rebated door leaf construction:

- Hard Edge K door edge profile
- stabilizing honeycomb insert, peripheral frame made of softwood
- two silver screwed pintle hinges (leaves 100' - 3 hinges, leaves reinforced, regardless of size - 3 hinges)
- lock for regular key, bathroom key, cylinder lock, mortise lock
- single leaf 60'- 100'
- double leaf 120'-200'
- sliding single and double leaf doors

#### Non-rebated B door leaf construction:

- construction: Classen Hard/peripheral frame made of softwood
- Hard Edge B door leaf edge profile
- two openings for 3D hidden hinges for non-rebated door

- magnetic lock: mortise lock, standard key lock, bathroom lock, cylinder lock
- single leaf 60'- 100'

### OPTIONS FOR ADDITIONAL PAYMENT

#### VENTILATION

- ventilation undercut
- ventilation undercut 15mm (recuperation)
- ventilation sleeves (available in white only)

#### CONSTRUCTION

- third hinge
- perforated chipboard (rebated and non-rebated B)
- non-rebated door leaf (B)
- door leaf 100': + **20%**

### DOOR FRAMES

#### HARD EDGE K:

- UV wood derivative door frame

#### HARD EDGE B:

- UV lacquered adjustable non-rebated door frame





m. 1.1



m. 1.2



m. 1.3 (with muntin)



m. 1.4 (with muntin)



m. 1.5



m. 1.6 (with muntin)



m. 1.7 (with muntin)



m. 2.1 (smooth)



m. 2.2



m. 2.3



m. 2.4



Cutter shape



m. 2.5



m. 2.6



m. 2.11



m. 2.12



m. 2.13 (WC)



Frame profile

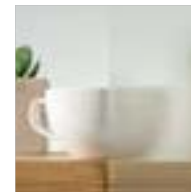

Satin glass

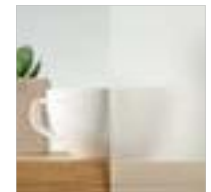

Safety glass, toughened, white (m. 1.2)

**Lacquered**



White UV





## LINEA PREMIUM

### EXECUTION STANDARD

- lacquered door leaf, rebated or non-rebated
- finishing: UV Pure lacquer, smooth surface
- Rebated door leaf construction:**
  - Hard Edge K door edge profile
  - stabilizing honeycomb insert, peripheral frame made of softwood
  - two silver screwed pintle hinges (leaves 100' – 3 hinges, leaves reinforced, regardless of size – 3 hinges)
  - lock for regular key, bathroom key, cylinder lock, mortise lock
  - single leaf 60'- 100'
  - double leaf 120'-200'
  - sliding single and double leaf doors
- Non-rebated B door leaf construction:**
  - construction: Classen Hard/peripheral frame made of softwood
  - Hard Edge B door leaf edge profile
  - two openings for 3D hidden hinges for non-rebated door
  - magnetic lock: mortise lock, standard key lock, bathroom lock, cylinder lock
  - single leaf 60'- 100'

### OPTIONS FOR ADDITIONAL PAYMENT

#### VENTILATION

- ventilation undercut
- ventilation undercut 15mm (recuperation)
- ventilation sleeves (available in white only)

#### CONSTRUCTION

- third hinge
- perforated chipboard (rebated and non-rebated B)
- non-rebated door leaf (B)
- door leaf 100': + **20%**

### DOOR FRAMES

#### HARD EDGE K:

- UV wood derivative door frame

#### HARD EDGE B:

- UV lacquered adjustable non-rebated door frame







m. 1



m. 2



m. 3



m. 4



m. 5



m. 10 (smooth)

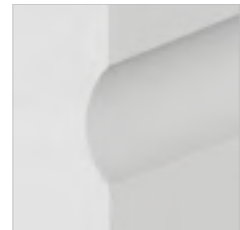

Cutter shape

**Lacquered**

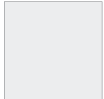

White UV Pure



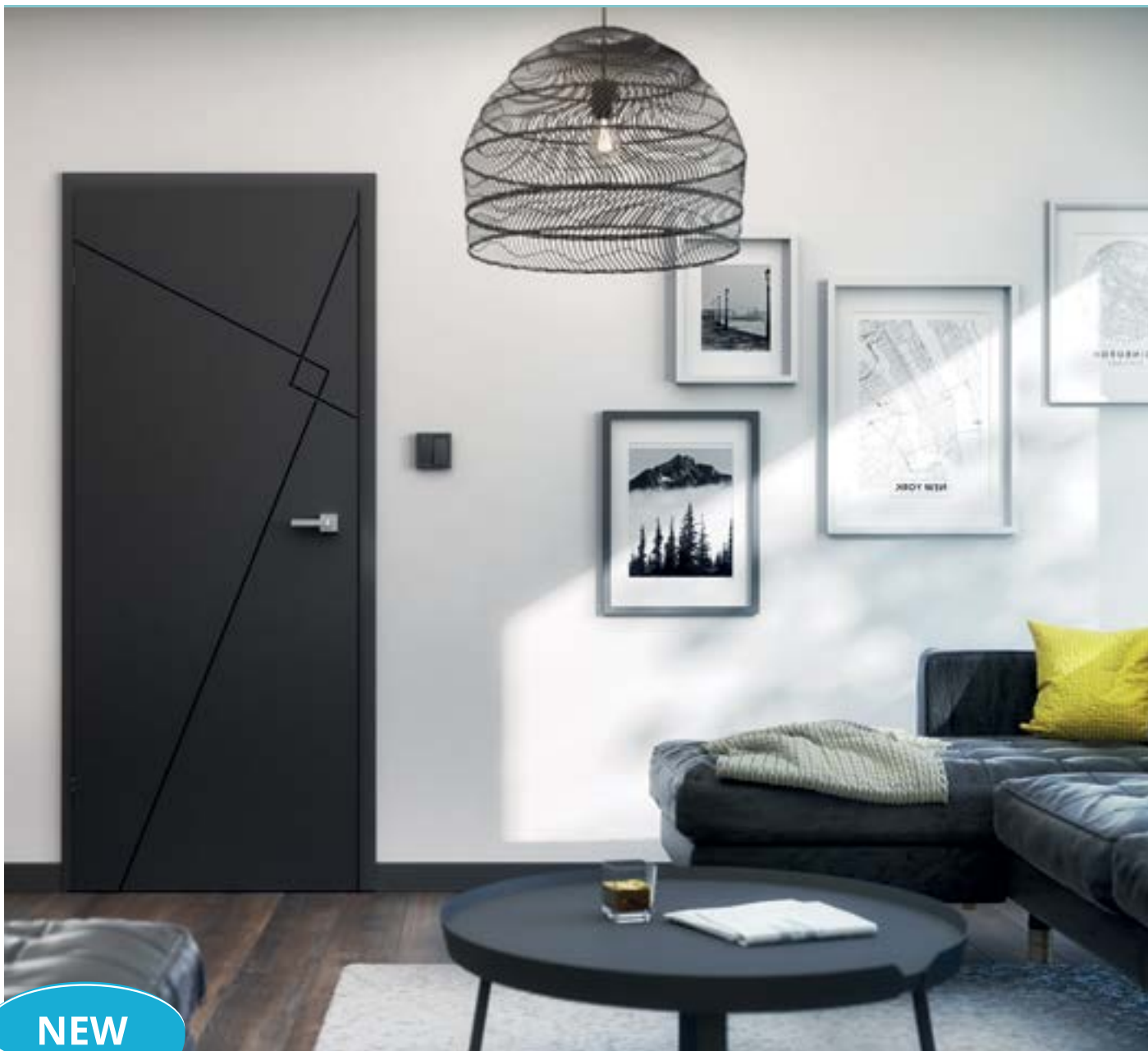

NEW

## LINEA PREMIUM LOFT

### EXECUTION STANDARD

- lacquered door leaf, rebated or non-rebated
- finishing: polyurethane varnish, smooth surface
- min. order quantity - 2 sets

#### rebated door leaf construction:

- Hard Edge K door edge profile
- stabilizing honeycomb insert, peripheral frame made of softwood
- two silver screwed pintle hinges (leaves 100' and leaves reinforced, regardless of size - 3 hinges)
- standard key lock, bathroom lock, cylinder lock, mortise lock
- single leaf 60' - 100'
- double leaf 120'-200'
- sliding single and double leaf doors

#### non-rebated B door leaf construction:

- construction: Classen Hard/peripheral frame made of softwood
- Hard Edge B door leaf edge profile
- two openings for 3D hidden hinges
- magnetic lock: mortise lock, standard key lock, bathroom lock, cylinder lock
- single leaf 60' - 100'

### OPTIONS FOR ADDITIONAL PAYMENT

#### VENTILATION

- ventilation undercut
- ventilation undercut 15mm (recuperation)
- ventilation sleeves (graphite)

#### CONSTRUCTION

- third hinge
- perforated chipboard (rebated and non-rebated B)
- non-rebated door leaf (B)
- door leaf 100': + **20%**

### DOOR FRAMES

#### HARD EDGE K:

- lacquered wood derivative door frame + **25%**

#### HARD EDGE B:

- lacquered adjustable non-rebated door frame + **25%**



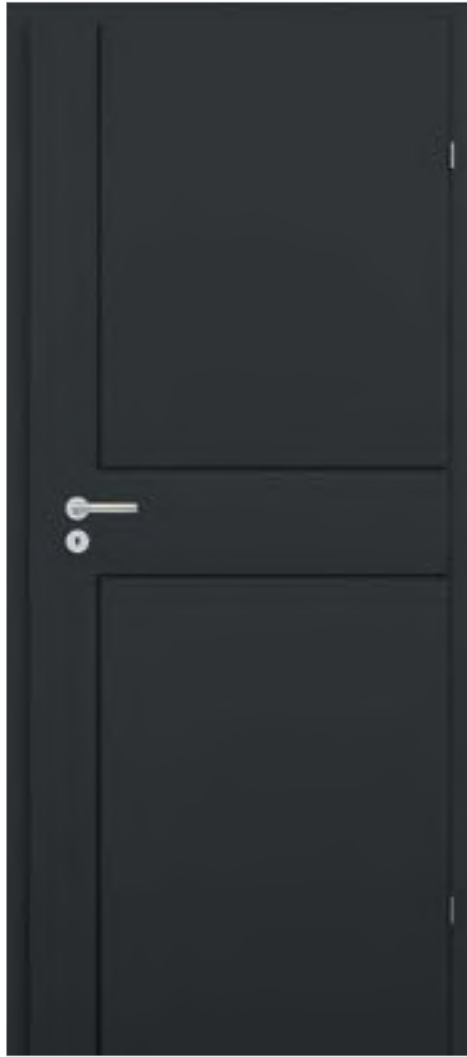

m. 1



m. 2



m. 3



m. 4



m. 5



m. 10 (smooth)



Cutter shape

Min. order quantity - 2 sets, (door leaf + door frame)

**Lacquered black matt**





panele : Classen Life Oak Hamburg 35029

## MORANO

### EXECUTION STANDARD

- lacquered door leaf- Lacquered UV, smooth surface
- construction: stabilizing honeycomb insert, peripheral frame made of softwood
- Rebated door leaf construction:**
  - Hard Edge K door edge profile
  - two silver screwed pintle hinges (leaves 100' - 3 hinges, leaves reinforced, regardless of size - 3 hinges)
  - lock for regular key, bathroom key, cylinder lock, mortise lock
  - satin glass
  - glazing beads veneered with PR - White decor except for models 2.7 - 2.10 - lacquered frame
  - single leaf 60'-90'
  - double leaf 120'-180'
  - sliding single and double leaf doors
- Non-rebated B door leaf construction:**
  - construction: Classen Hard/peripheral frame made of softwood
  - Hard Edge B door leaf edge profile
  - two openings for 3D hidden hinges for non-rebated door

- magnetic lock: mortise lock, standard key lock, bathroom lock, cylinder lock
- single leaf 60'- 90'

### OPTIONS FOR ADDITIONAL PAYMENT

#### VENTILATION

- ventilation undercut
- ventilation undercut 15mm (recuperation)
- ventilation sleeves (available in white only)

#### CONSTRUCTION

- third hinge
- non-rebated door leaf (B)

#### GLAZING

- transparent glass for models: 1.4 1.5 2.3 2.4

### DOOR FRAMES

#### HARD EDGE K:

- wood-based and steel rebated door frames

#### HARD EDGE B:

- non-rebated adjustable door frames





m. 1.1



m. 1.2



m. 1.3



m. 1.4



m. 1.5 (with muntin)



m. 2.1



m. 2.2



m. 2.3



m. 2.4 (with muntin)



m. 2.5 (with muntin)



m. 2.6



m. 2.7



m. 2.8



m. 2.9 (with muntin)



m. 2.10 (with muntin)



Frame profile



Satin glass



Transparent glass, optional for the model 1.4, 1.5, 2.3, 2.4



Frame profile

**Important!**  
In case of door leaves with width of 60', the width of handle escutcheons should be take into account. Possibility of installing handle with escutcheon with max. width of 50 mm.

**Lacquered**

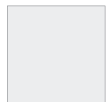

White UV





## GRAFEN

### EXECUTION STANDARD

- lacquered door leaf, rebated or non-rebated
- finishing: UV Pure lacquer, smooth surface
- Rebated door leaf construction:**
- Hard Edge K door edge profile
- stabilizing honeycomb insert, peripheral frame made of softwood
- two silver screwed pintle hinges (leaves 100' – 3 hinges, leaves reinforced, regardless of size – 3 hinges)
- lock for regular key, bathroom key, cylinder lock, mortise lock
- single leaf 60'- 100'
- double leaf 120'-200'
- sliding single and double leaf doors
- Non-rebated B door leaf construction:**
- construction Classen Hard/peripheral frame made of softwood
- Hard Edge B door leaf edge profile
- two openings for 3D hidden hinges for non-rebated door
- magnetic lock: mortise lock, standard key lock, bathroom lock, cylinder lock
- single leaf 60'- 100'

### OPTIONS FOR ADDITIONAL PAYMENT

#### VENTILATION

- ventilation undercut
- ventilation undercut 15mm (recuperation)
- ventilation sleeves (available in white only)

#### CONSTRUCTION

- third hinge
- perforated chipboard (rebated and non-rebated B)
- non-rebated door leaf (B)
- door leaf 100': + **20%**

### DOOR FRAMES

#### HARD EDGE K:

- UV wood derivative door frame

#### HARD EDGE B:

- UV lacquered adjustable non-rebated door frame





m. 1



m. 2



m. 3



m. 4



Cutter shape

**Lacquered**



White UV Pure





## SALVANO

### EXECUTION STANDARD

- lacquered door leaf
- peripheral frame made of softwood reinforced with perforated chipboard

#### Rebated door leaf construction:

- Hard Edge K door edge profile
- 3 silver screwed pintle hinges
- standard key lock, bathroom lock, cylinder lock, mortise lock
- safety glass, toughened, white
- single leaf 70' - 100'

#### Non-rebated B door leaf construction:

- peripheral frame made of softwood reinforced with perforated chipboard
- Hard Edge B door leaf edge profile
- two openings for 3D hidden hinges for non-rebated door
- magnetic lock: mortise lock, standard key lock, bathroom lock, cylinder lock
- single leaf 70' - 100'

### OPTIONS FOR ADDITIONAL PAYMENT

#### VENTILATION

- ventilation undercut

#### CONSTRUCTION

- non-rebated door leaf (B)
- door leaf 100': + **20%**

### DOOR FRAMES

#### HARD EDGE K:

- UV wood derivative door frame  
oraz stalowe do door przlgowych

#### HARD EDGE B:

- UV lacquered adjustable non-rebated door frame







m. 1



m. 2



m. 3



m. 4



m. 5



Safety glass, toughened, white



Ventilation undercut for all models

**Lacquered**

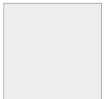

White UV Pure



Kitchen: Classen Arvada floor: Classen Adventure Oak Hamilton 28590

## CLASSIC

### EXECUTION STANDARD

- lacquered door leaf
- construction: stabilizing honeycomb insert, peripheral frame made of MDF
- Hard Edge K door edge profile
- finishing: white UV lacquered
- two silver screwed pintle hinges
- lock for regular key, bathroom key, cylinder lock
- ornament glass
- single leaf 60"-90"
- double leaf 120"-180"

### OPTIONS FOR ADDITIONAL PAYMENT

#### VENTILATION

- ventilation sleeves
- ventilation grille

#### CONSTRUCTION

- third hinge

### DOOR FRAMES

#### HARD EDGE K:

- wood-based and steel door frames for rebated door





full



1/3 glass



2/3 glass

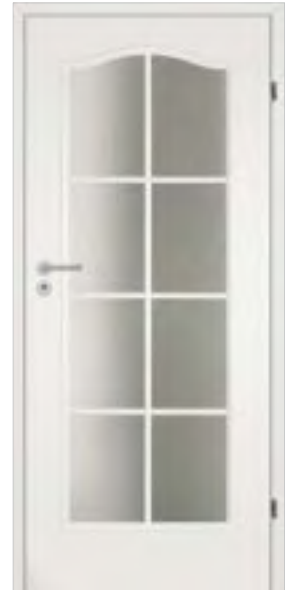

3/3 glass



Ornament glass



Frame profile

**Lacquered HDF**



White UV  
with structure



classic and durability  
WIDE CHOICE OF MODELS

# FRAMED DOORS

Classic at its best. A great proposition for those who instead of succumbing to seasonal fashions, choose timeless elegance. The framed construction provides the leaves with stability and increased resistance to damage. Inside the strong frame there are various types of fillings, including coffers, glazing, HDF panels and even mirrors. The variety of available models not only provides a real feast for the eye, but also a comfortable choice for future users. Choosing the door that best suits individual preferences and is precisely tailored to the needs of buyers.



DO YOU WANT TO GIVE SOME WARMTH TO THE DECOR?

For this purpose, wood is great. Not only on the floor, but also on the door leaves. Wood-like veneers with a three-dimensional structure will enhance the feeling of cosiness.

INTERIOR CLOSE TO NATURE. Live plants, woven baskets and ecological decorations create a wonderful atmosphere. It will be complemented by wood structure framed door, which you can easily adapt to the colour scheme of your apartment.





**NEW**

## CLIF

### EXECUTION STANDARD

- modular elements made of MDF
- finishing: Classen Primo, Iridium, 3D Look, CPL
- satin glass or HDF board in the door leaf colour, thickness 4 mm
- K door leaf edge profile
- 3 silver screwed hinges
- standard key lock, bathroom lock, cylinder lock, mortise lock
- single leaf: 60'-100'
- double leaf: 120'-200'
- sliding single and double leaf doors

### OPTIONS FOR ADDITIONAL PAYMENT

#### VENTILATION

- ventilation undercut

#### CONSTRUCTION

- door leaf 100': + 20%

#### DOOR FRAMES

- wood-based and steel door frames for rebated door





m. 1



m. 2



m. 3



m. 4



m. 5



m. 6



Satin glass

**3D Look**

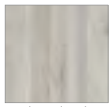

Light Columbia  
Walnut

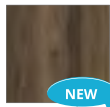

Catania Oak

NEW

**Iridium**

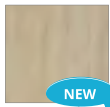

Marone Oak

NEW



Grey matt

NEW

**CPL**



Norwegian Ash



## MAGNETIC

### EXECUTION STANDARD

- modular elements made of MDF
- finishing: Classen Primo, Iridium, 3D Look, CPL
- satin glass or HDF board in the door leaf colour, thickness 4 mm
- K door leaf edge profile
- 3 silver screwed hinges
- standard key lock, bathroom lock, cylinder lock, mortise lock
- single leaf: 60'-100'
- double leaf: 120'-200'
- sliding single and double leaf doors

### OPTIONS FOR ADDITIONAL PAYMENT

#### VENTILATION

- ventilation undercut

#### CONSTRUCTION

- door leaf 100': + **20%**

#### DOOR FRAMES

- wood-based and steel door frames for rebated door





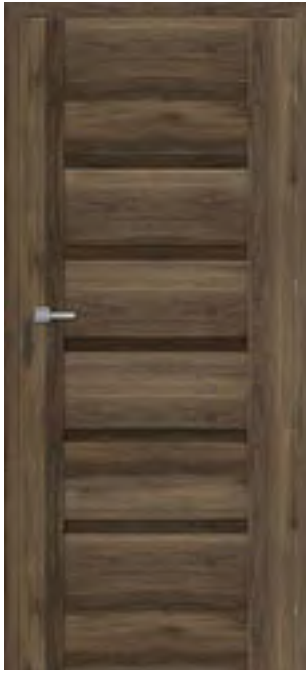

m. 1



m. 2



m. 3



m. 4



m. 5



Satin glass



m. 6



m. 7



m. 8

**3D Look**

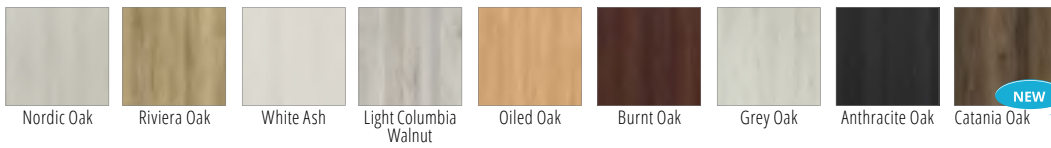

**Iridium**



**CPL**





Kitchen: Classen Juliet / floor: Classen Galaxy4V Dab Martossa D6095

## GRECO

### EXECUTION STANDARD

- modular elements made of MDF
- finishing: Classen Primo, Iridium, 3D Look, CPL
- satin glass or HDF board in the door leaf colour, thickness 4 mm
- K door leaf edge profile
- 3 silver screwed hinges
- standard key lock, cylinder lock, bathroom lock, mortise lock
- single leaf: 60'-100'
- double leaf: 120'-200'
- sliding single and double leaf doors

### OPTIONS FOR ADDITIONAL PAYMENT

#### VENTILATION

- ventilation undercut

#### CONSTRUCTION

- door leaf 100': + **20%**

#### DOOR FRAMES

- wood-based and steel door frames for rebated door





m. 1



m. 2



m. 3



m. 4



m. 5



m. 6



m. 7



m. 8



m. 9

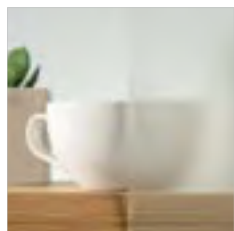

Satin glass

**3D Look**



**Iridium**



**CPL**





## TRAFFIC

### EXECUTION STANDARD

- modular elements made of MDF
- finishing: Classen Iridium, 3D Look, CPL
- satin glass or HDF board in the door leaf colour, thickness 4 mm
- K door leaf edge profile
- 3 silver screwed hinges
- standard key lock, bathroom lock, cylinder lock, mortise lock
- single leaf: 60'-100'
- double leaf: 120'-200'
- sliding single and double leaf doors

### OPTIONS FOR ADDITIONAL PAYMENT

#### VENTILATION

- ventilation undercut

#### CONSTRUCTION

- door leaf 100': + 20%

### DOOR FRAMES

- wood-based and steel door frames for rebated door





m. 1



m. 2



m. 3



m. 4



m. 5



Satin glass



m. 6



m. 7



m. 8

### 3D Look



Nordic Oak



Riviera Oak

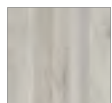

Light Columbia  
Walnut



White Ash



Oiled Oak



Burnt Oak



Grey Oak



Sonoma Oak



Anthracite Oak

### Iridium



Graphite Ash



White matt

### CPL



Norwegian Ash



## HAVANA

### EXECUTION STANDARD

- modular elements made of MDF
- finishing: Classen Iridium, 3D Look, CPL
- satin glass or HDF board in the door leaf colour, thickness 4 mm
- K door leaf edge profile
- 3 silver screwed hinges
- standard key lock, cylinder lock, bathroom lock, mortise lock
- single leaf: 60'-100'
- double leaf: 120'-200'
- sliding single and double leaf doors

### OPTIONS FOR ADDITIONAL PAYMENT

#### VENTILATION

- ventilation undercut

#### CONSTRUCTION

- door leaf 100': + 20%

### DOOR FRAMES

- wood-based and steel door frames for rebated door





m. 1



m. 2



m. 3



m. 4



m. 5

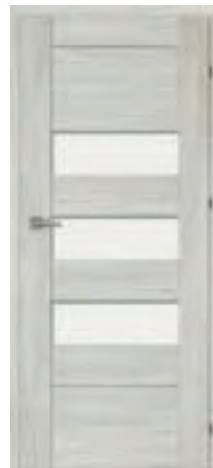

m. 6



m. 7



Satin glass

**3D Look**



Nordic Oak

Riviera Oak

Light Columbia Walnut

White Ash

Oiled Oak

Burnt Oak

Grey Oak

Sonoma Oak

Anthracite Oak

**Iridium**

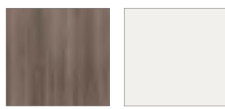

Graphite Ash

White matt

**CPL**



Norwegian Ash



Kitchen: Classen Flint / floor: Classen Adventure Hamilton Oak 28590

## LUKKA

### EXECUTION STANDARD

- modular elements made of MDF
- finishing: Classen Iridium, 3D Look, CPL
- satin glass or HDF board in the door leaf colour, thickness 4 mm
- K door leaf edge profile
- 3 silver screwed hinges
- standard key lock, cylinder lock, bathroom lock, mortise lock
- single leaf: 60'-100'
- double leaf: 120'-200'
- sliding single and double leaf doors

### OPTIONS FOR ADDITIONAL PAYMENT

#### VENTILATION

- ventilation undercut

#### CONSTRUCTION

- door leaf 100': + 20%

### DOOR FRAMES

- wood-based and steel door frames for rebated door







m. 1



m. 2



m. 3



m. 4



m. 5



Satin glass

**3D Look**



Riviera Oak



White Ash



Light Columbia  
Walnut



Oiled Oak



Burnt Oak



Anthracite Oak

**Iridium**



Graphite Ash



White matt

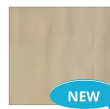

Marone Oak

**CPL**



Norwegian Ash



floor: Classen Hossegor Oak 49770 XL

## TOSCA

### EXECUTION STANDARD

- modular elements made of MDF
- finishing: Classen Primo, Iridium, 3D Look, CPL
- satin glass or HDF board in the door leaf colour, thickness 4 mm
- K door leaf edge profile
- 3 silver screwed hinges
- lock for regular key, bathroom key, cylinder lock, mortise lock
- single leaf: 60'-100'
- double leaf: 120'-200'
- sliding single and double leaf doors

### OPTIONS FOR ADDITIONAL PAYMENT

#### VENTILATION

- ventilation undercut

#### CONSTRUCTION

- door leaf 100': + 20%

### DOOR FRAMES

- wood-based and steel door frames for rebated door





m. 1



m. 2



m. 3



m. 4



m. 5

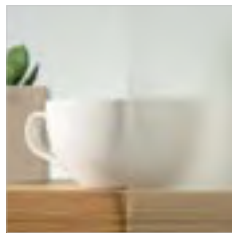

Satin glass



m. 6



m. 7



m. 8

**3D Look**



**Iridium**



**CPL**





## FERRO

### EXECUTION STANDARD

- modular elements: peripheral frame made of softwood, reinforced with chipboard
- finishing: Classen Iridium, CPL
- white toughened glass or a board with the thickness of 17 mm
- model 3 one-side mirror, external or internal
- **Rebated door leaf construction:**
  - K door leaf edge profile
  - 3 silver screwed hinges
  - lock for regular key, bathroom key, cylinder lock, mortise lock
  - single leaf: 60'-100'
  - sliding single leaf door
- **Non-rebated B door leaf construction:**
  - Hard Edge B door leaf edge profile
  - two openings for 3D hidden hinges for non-rebated door
  - magnetic lock: mortise lock, standard key lock, bathroom lock, cylinder lock
  - single leaf: 60'-100'

### OPTIONS FOR ADDITIONAL PAYMENT

#### VENTILATION

- ventilation undercut
- ventilation sleeves - PVC with CPL woodgrain foil

#### CONSTRUCTION

- non-rebated door leaf (B)
- door leaf 100': + **20%**

### DOOR FRAMES

#### HARD EDGE K:

- wood-based and steel door frames for rebated door

#### HARD EDGE B:

- non-rebated adjustable door frames





m.1



m.2



m.3 one-sided mirror



m.4

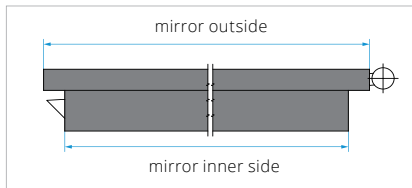

Door leaf profile

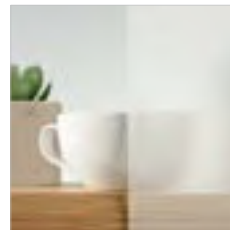

Safety glass, toughened, white

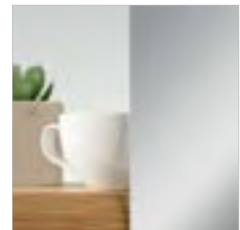

Mirror

**Iridium**



Graphite Ash

**CPL**



Italian Walnut



Acacia



Acacia light



Norwegian Ash



Grigio Oak



Kendal Oak



## KOFANO

### EXECUTION STANDARD

- modular elements made of MDF
- finishing: Classen Iridium, 3D Look, CPL
- satin glass, thickness 4 mm (models 1.2, 1.4 - safety glass, toughened, white) or coffering
- K door leaf edge profile
- 3 silver screwed hinges
- standard key lock, bathroom lock, cylinder lock, mortise lock
- single leaf: 60'-100'
- double leaf: 120'-200'
- sliding single and double leaf doors

### OPTIONS FOR ADDITIONAL PAYMENT

#### VENTILATION

- ventilation undercut

#### CONSTRUCTION

- door leaf 100': + 20%

### DOOR FRAMES

#### HARD EDGE K:

- wood-based and steel door frames for rebated door



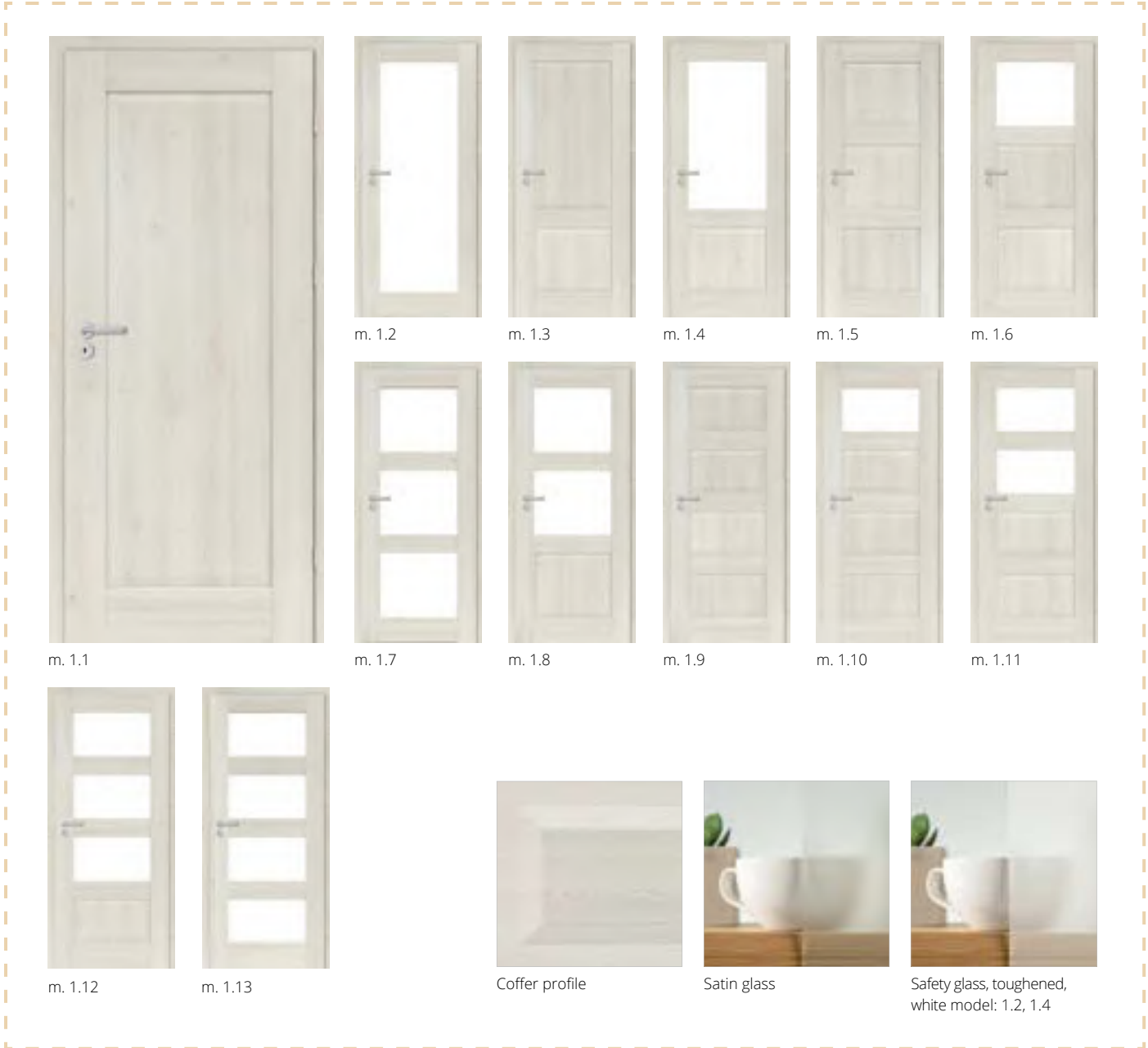

**3D Look**



**Iridium**



**CPL**





## ANTICA

### EXECUTION STANDARD

- modular elements made of MDF
- finishing: Classen Iridium, 3D Look, CPL
- satin glass gr. 4 mm or kaseton wypukły
- K door leaf edge profile
- 3 silver screwed hinges
- standard key lock, bathroom lock, cylinder lock, mortise lock
- single leaf: 60'- 90'
- double leaf: 120'-200'
- sliding single and double leaf doors

### OPTIONS FOR ADDITIONAL PAYMENT

#### VENTILATION

- ventilation undercut

#### CONSTRUCTION

- door leaf 100': + **20%**

#### DOOR FRAMES

##### HARD EDGE K:

- wood-based and steel door frames for rebated door







m. 1



m. 2



m. 3



Coffer shape

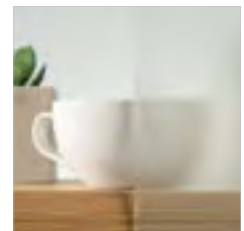

Satin glass

**3D Look**



Nordic Oak

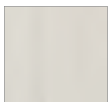

White Ash



Oiled Oak



Burnt Oak



Anthracite Oak



Grey Oak

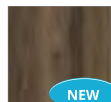

Catania Oak

**Iridium**



Graphite Ash

**CPL**



Norwegian Ash

versatile use  
WIDE CHOICE OF DECORS



# veneer panel doors

Universal and thus guaranteeing versatile use. They are perfect for every room - from the kitchen, through the living room, to the bathroom. With their help, you can create a consistent decor of the entire apartment or house. The veneers covering the leaves are durable and resistant to scratches. Their advantage is also the variety of designs that fit into current trends and reflect the texture of the wood. Among them you can find not only classic beige and brown, but also shades of white, grey or anthracite. This rich palette of decors allows you to easily adapt them to any style of arrangement.



## SCANDINAVIAN INTERIOR WITH A BOHO NOTE.

An interesting combination for those who are looking for a way to break the simplicity of Scandinavian style. It is worth completing the arrangement of the door in white veneer, reflecting the texture of wood.

CLASSICS - YES, BOREDOM - NO. Are you looking for a timeless door that stands out at the same time? Bet on the leaves finished with veneer. You can choose from many different colours. You will definitely find one that will create a coherent composition with the other elements of the decor.





# SAGA

## EXECUTION STANDARD

- veneered door leaf
- peripheral frame made of softwood, filling - perforated chipboard

### Rebated door leaf construction:

- Hard Edge K door edge profile
- 3 silver screwed pintle hinges
- finishing: Classen CPL
- overprint: aluminium profile, width: 8 mm, aligned with a door leaf surface
- lock for regular key, bathroom key, cylinder lock, mortise lock
- single leaf: 60'-100'
- double leaf 120'-200'
- sliding single and double leaf doors

### Non-rebated B door leaf construction:

- Hard Edge B door leaf edge profile
- two openings for 3D hidden hinges for non-rebated door
- magnetic lock: mortise lock, standard key lock, bathroom lock, cylinder lock
- single leaf 60'-100'

## OPTIONS FOR ADDITIONAL PAYMENT

### VENTILATION

- ventilation undercut
- ventilation undercut 15mm (recuperation)
- ventilation sleeves - PVC

### CONSTRUCTION

- door leaf 100': + **20%**
- non-rebated door leaf (B)

## DOOR FRAMES

### HARD EDGE K:

- wood-based and steel rebated door frames

### HARD EDGE B:

- non-rebated adjustable door frames





m. 1 / 1a / 1b



m. 2 / 2a / 2b



m. 3 / 3a / 3b



m. 4 / 4a / 4b



m. 5 / 5a / 5b

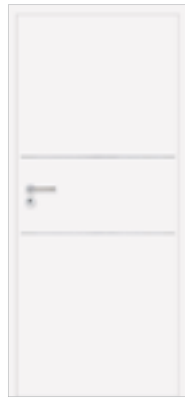

m. 6 / 6a / 6b

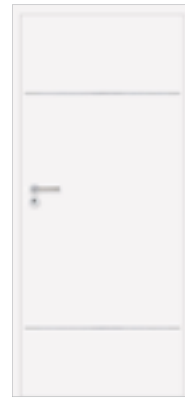

m. 7 / 7a / 7b



Aluminium profile \*)



White door leaf rebate  
models 1 - 7



Door rebate in aluminium  
colour  
models 1a - 7a



Door rebate in veneer decor  
models 1b - 7b

\*) Aluminium profile, width: 8mm (colour - stainless steel / INOX), aligned with a door leaf surface.

CPL



White RAL 9003



White structure  
horizontal



## ASTERIA NL

### EXECUTION STANDARD

- veneered door leaf
- construction: stabilizing insert - lightweight board peripheral frame made of softwood
- finishing: Classen Iridium, Classen CPL

#### Rebated door leaf construction:

- door leaf edge profile: Hard Edge K
- 3 silver screwed pintle hinges
- lock for regular key, bathroom key, cylinder lock, mortise lock
- painted glass, non-transparent, colourimo, graphite
- single leaf 70'-100'
- double leaf 140'-200'
- sliding single and double leaf doors

#### Non-rebated B door leaf construction:

- door leaf edge profile Asteria NL B (Hard Edge B)
- two openings for 3D hidden hinges for non-rebated door
- magnetic lock: mortise lock, standard key lock, bathroom lock, cylinder lock
- single leaf: 70'-100'

### OPTIONS FOR ADDITIONAL PAYMENT

#### VENTILATION

- ventilation undercut
- ventilation undercut 15mm (recuperation)
- ventilation sleeves UNI
- ventilation sleeves - PVC with CPL, IR woodgrain foil
- ventilation sleeves steel - chrome, satin

#### CONSTRUCTION

- door leaf 100': + 20%
- non-rebated door leaf (NL\_B)

### DOOR FRAMES

#### HARD EDGE K:

- wood-based and steel rebated door frames

#### HARD EDGE B:

- non-rebated adjustable door frames





m. 1



m. 2



m. 3



m. 4



m. 5

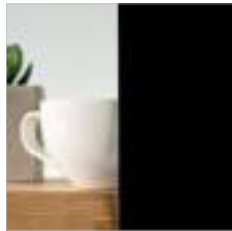

Painted glass: graphite,  
aligned with a door leaf surface



m. 6



m. 7



m. 8



m. 9

**Iridium**



Graphite Ash

Snow Ash

**CPL**



Italian Walnut

Acacia

Acacia light

Norwegian Ash

Grigio Oak

Kendal Oak

White RAL 9003

Grey RAL 7047

Graphite RAL 7024

NEW



## ASTERIA

### EXECUTION STANDARD

- veneered door leaf
- **Rebated door leaf construction:**
  - peripheral frame made of softwood, filling - HLT full chipboard
  - 3 silver screwed pintle hinges
  - finishing: Classen Iridium, Classen CPL
  - lock for regular key, bathroom key, cylinder lock, mortise lock
  - toughened safety graphite, transparent glazing with overprint
  - single leaf 70'-100'
  - double leaf 140'-200'
  - sliding single and double leaf doors
- **Non-rebated B door leaf construction:**
  - peripheral frame made of softwood, filling - HLT full chipboard
  - Hard Edge B door leaf edge profile
  - two openings for 3D hidden hinges for non-rebated door
  - magnetic lock: mortise lock, standard key lock, bathroom lock, cylinder lock
  - single leaf 70'-90'

### OPTIONS FOR ADDITIONAL PAYMENT

#### VENTILATION

- ventilation undercut
- ventilation undercut 15mm (recuperation)
- ventilation sleeves steel - chrome, satin

#### GLAZING

- safety glass, graphite-satin with overprint - raster\*)
- model 6
- model 7, 9
- model 8

#### CONSTRUCTION

- door leaf 100': + 20%
- non-rebated door leaf (B)

### DOOR FRAMES

#### HARD EDGE K:

- wood-based and steel rebated door frames

#### HARD EDGE B:

- non-rebated adjustable door frames







m.6



m.7



m.8



m.9



Toughened glass, graphite - transparent (raster)

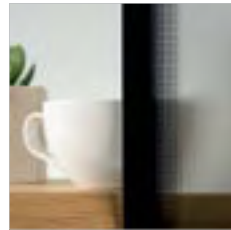

**Additional payment \*)**  
Graphite satine with over-print - raster, aligned with a door leaf surface.

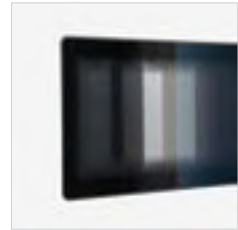

Glass aligned with a door leaf surface

\*) Important! Glasses as option for additional payment - longer delivery time.

\*\*) Classen Hard Edge PF door leaf rebate construction for CPL finishing, page - 138.

**Iridium**



Graphite Ash

**CPL\*\*)**



Italian Walnut



Acacia



Acacia light



Norwegian Ash



Grigio Oak



Kendal Oak

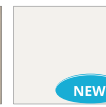

White RAL 9003

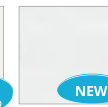

White structure horizontal



## DISCOVERY

### EXECUTION STANDARD

- veneered door leaf
- **Rebated door leaf construction:**
- **Hard Edge R** door leaf edge profile for Iridium decors, peripheral frame made of softwood, filling: with perforated chipboard (models 4-11), Classen Hard construction (models 1-3)
- **Hard Edge PF** door leaf edge profile for CPL decors, peripheral frame made of MDF board, reinforced with plywood, filling with perforated chipboard (models 4-11), Classen Hard construction (models 1-3)
- 3 silver screwed pintle hinges
- finishing: Classen Iridium, Classen CPL
- overprint: aluminium profile, width: 8 mm, aligned with a door leaf surface
- lock for regular key, bathroom key, cylinder lock, mortise lock
- toughened safety graphite, transparent glazing with overprint
- single leaf 60'-100'
- double leaf 120'-200'
- sliding single and double leaf doors

### Non-rebated B door leaf construction:

- Hard Edge B door leaf edge profile
- two openings for 3D hidden hinges for non-rebated door
- magnetic lock: mortise lock, standard key lock, bathroom lock, cylinder lock
- single leaf 70'-90'

### OPTIONS FOR ADDITIONAL PAYMENT

#### VENTILATION

- ventilation undercut
- ventilation undercut 15mm (recuperation)
- ventilation sleeves - PVC with CPL, IR woodgrain foil

#### CONSTRUCTION

- door leaf 100': + 20%

### DOOR FRAMES

#### HARD EDGE K:

- wood-based and steel rebated door frames

#### HARD EDGE B:

- non-rebated adjustable door frames





m. 1

m. 2

m. 3

m. 4



m. 5

m. 6

m. 10

m. 11



Aluminium profile \*)



Frame profile



Safety glass, toughened, white

\*) Aluminium profile, width: 8mm (colour - stainless steel / INOX), aligned with a door leaf surface.  
 \*\*) Classen Hard Edge PF door leaf rebate construction for CPL finishing, page - 138.

**Iridium**

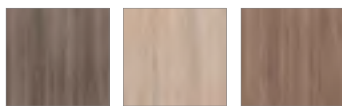

Graphite Ash

Snow Ash

Brown Ash

**CPL\*\*)**



Italian Walnut

Acacia

Acacia light

Norwegian Ash

Grigio Oak

Kendal Oak

White RAL 9003

White structure horizontal



Kitchen: Classen Clio Milk floor: Classen VISIOGRANDE Infinity Arktis 44482

## TETYDA

### EXECUTION STANDARD

- veneered door leaf
- **Rebated door leaf construction:**
- **Hard Edge R** door leaf edge profile dla for 3D Look and Iridium decors, construction: Classen Hard / peripheral frame made of softwood
- **Hard Edge PF** door leaf edge profile for CPL decors, Classen Hard construction, peripheral frame made of MDF board, reinforced with plywood
- two silver screwed pintle hinges (leaves 100' and leaves reinforced, regardless of size - 3 hinges)
- finishing: Classen Iridium, Classen CPL, Classen 3D Look
- overprint: aluminium profile, width: 6 mm
- lock for regular key, bathroom key, cylinder lock, mortise lock
- safety glass, toughened, Estriado, satin bronze, satin graphite
- single leaf: 60'-100'
- double leaf 120'-200'
- sliding single and double leaf doors
- **Non-rebated B door leaf construction:**
- construction: Classen Hard/peripheral frame made of softwood

- finishing: Classen Iridium, Classen CPL
- Hard Edge B door leaf edge profile
- two openings for 3D hidden hinges for non-rebated door
- lock for regular key, bathroom key, cylinder lock, mortise lock
- single leaf 70'-90'

### OPTIONS FOR ADDITIONAL PAYMENT

#### VENTILATION

- ventilation undercut
- ventilation undercut 15mm (recuperation)
- ventilation sleeves - PVC with woodgrain foil
- ventilation sleeves 3D

#### CONSTRUCTION

- door leaf 100': + 20%
- third hinge
- reinforced with perforated chipboard\*\*)

### DOOR FRAMES

#### HARD EDGE K:

- wood-based and steel rebated door frames

#### HARD EDGE B:

- non-rebated adjustable door frames





m. 1



m. 2



m. 3



m. 4



m. 5



Aluminium profile



Glazing beads profile

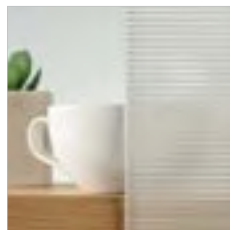

Estriado glass



Graphite satin glass



Bronze satin glass

\*) Not available in non-rebated models (Hard Edge B).

\*\*) No Hard reinforcement.

\*\*\*) Classen Hard Edge PF door leaf rebate construction for CPL finishing, page - 138.

**3D Look**



Sonoma Oak \*)   Riviera Oak   Light Columbia Walnut \*)   White Ash \*)   Oiled Oak \*)   Burnt Oak \*)   Grey Oak

**Iridium**



Graphite Ash   Snow Ash   Wenge \*)

**CPL\*\*\*)**



Brown Ash   Marone Oak \*)   Norwegian Ash   Acacia   Grigio Oak   Kendal Oak   Italian Walnut   Acacia light   White RAL 9003 (NEW)   White structure horizontal (NEW)



## NATURA HR

### EXECUTION STANDARD

- veneered door leaf
- **Hard Edge R** door leaf edge profile dla for 3D Look and Iridium decors, construction: Classen Hard / peripheral frame made of softwood
- **Hard Edge PF** door leaf edge profile for CPL decors, peripheral frame made of MDF board, reinforced with plywood, Classen Hard construction
- finishing: Classen: Primo, Iridium, 3D Look, CPL
- two silver screwed pintle hinges (leaves 100' - 3 hinges, leaves reinforced, regardless of size - 3 hinges)
- lock for regular key, bathroom key, cylinder lock, mortise lock
- toughened safety white glazing
- single leaf 60'-120'
- double leaf 120'-200'
- sliding single and double leaf doors (max. door leaf width 100')

### OPTIONS FOR ADDITIONAL PAYMENT

#### VENTILATION

- ventilation undercut
- ventilation undercut 15mm (recuperation)
- ventilation sleeves
- ventilation sleeves - PVC with CPL, IR woodgrain foil

#### GLAZING

- bullseye 35ml for model 1
- glazing for additional payment - details in the price list
- transparent glass

#### CONSTRUCTION

- third hinge
- perforated chipboard\*\*)
- full chipboard\*\*\*)
- door leaf 100': + **20%**
- door leaf 110': + **30%**
- door leaf 120': + **35%**

### DOOR FRAMES

- wood-based and steel door frames for rebated door





m. 1



m. 2



m. 3



m. 4



m.1 with bullseye window and ventilation sleeves\*1)



Glazing beads profile



Safety glass, toughened, white

\*1) Door leaf with bullseye is not available in sliding version, more on page 140.

\*\*\*) No Hard reinforcement, max. door leaf width 110'.

\*\*\*\*) No Hard reinforcement, max. door leaf width 100'.

\*\*\*\*\*) Classen Hard Edge PF door leaf rebate construction for CPL finishing, page - 138.

**Primo**



Acacia St    Beech    Natural Oak    Walnut

**3D Look**



Sonoma Oak    Riviera Oak    White Ash    Light Columbia Walnut    Oiled Oak    Burnt Oak

**Iridium**



Grey Oak    Catania Oak    Graphite Ash    Snow Ash    Wenge    Brown Ash    Marone Oak

**CPL \*\*\*\*\*)**



Norwegian Ash    Acacia



Grigio Oak    Kendal Oak    Italian Walnut    Acacia light    White RAL 9003    White structure horizontal



## ANDROMEDA

### EXECUTION STANDARD

- veneered door leaf
- **Rebated B door leaf construction:**
- peripheral frame made of softwood, filling - perforated chipboard
- door leaf edge profile Hard Edge R
- finishing: Classen Iridium, Classen CPL
- 3 silver screwed pintle hinges
- standard key lock, bathroom lock, cylinder lock, mortise lock
- safety glass, toughened, white
- single leaf 70'-100'
- **Non-rebated B door leaf construction:**
- magnetic lock: mortise lock, standard key lock, bathroom lock, cylinder lock
- single leaf 70'-100'
- Hard Edge B door leaf edge profile
- two openings for 3D hidden hinges for non-rebated door

### OPTIONS FOR ADDITIONAL PAYMENT

#### VENTILATION

- ventilation undercut

#### CONSTRUCTION

- door leaf 100': + 20%
- non-rebated door leaf (B)

#### GLAZING

- safety glass, graphite-satin

### DOOR FRAMES

#### HARD EDGE K:

- wood-based and steel door frames for rebated door

#### HARD EDGE B:

- non-rebated adjustable door frames







m. 1



m. 2



m. 3



m. 4



m. 5



Ventilation undercut<sup>\*)</sup>



Safety glass, toughened, white



Additional payment  
Graphite satin glass

<sup>\*)</sup> ventilation undercut available for models 1-5.  
<sup>\*\*)</sup> not present in non-rebated models (Hard Edge B).

**Iridium**



Graphite Ash



Wenge



Marone Oak<sup>\*\*)</sup>

**CPL**



Italian Walnut



Acacia



Acacia light



Norwegian Ash



Grigio Oak



Kendal Oak

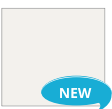

White RAL 9003



White structure horizontal



Kitchen: Classen Salem floor: Classen Forest SONO Opal Wood 41071

## DEMETER

### EXECUTION STANDARD

- veneered door leaf
- **Hard Edge R** door leaf edge profile dla for Primo, 3D Look and Iridium decors, Classen Hard construction, peripheral frame made of softwood
- **Hard Edge PF** door leaf edge profile for CPL decors, Classen Hard construction, peripheral frame made of MDF board, reinforced with plywood
- finishing: Classen Primo, Classen 3D Look, Classen Iridium, Classen CPL
- two silver screwed pintle hinges (leaves 100' – 3 hinges, leaves reinforced, regardless of size – 3 hinges)
- lock for regular key, bathroom key, cylinder lock, mortise lock
- toughened safety white glazing
- single leaf 60'-100' (models 1 i 4), 70'-100' (models 2, 3, 5)
- double leaf 140'-200'
- sliding single and double leaf doors

### OPTIONS FOR ADDITIONAL PAYMENT

#### VENTILATION

- ventilation undercut
- ventilation undercut 15mm (recuperation)
- ventilation sleeves PR, 3D
- ventilation sleeves - PVC with CPL, IR woodgrain foil

#### CONSTRUCTION

- door leaf 100': + 20%
- third hinge
- reinforced with perforated chipboard<sup>\*)</sup>

### DOOR FRAMES

- wood-based and steel door frames for rebated door





m. 1



m. 2



m. 3



m. 4



m. 5



Glazing beads profile



Safety glass, toughened, white

\*) No Hard reinforcement.

\*\*) Classen Hard Edge PF door leaf rebate construction for CPL finishing, page - 138.

**Primo**



Acacia St    Natural Oak    Walnut

**3D Look**



Sonoma Oak    Riviera Oak    White Ash    Light Columbia Walnut    Oiled Oak    Burnt Oak

**Iridium**



Grey Oak    Catania Oak    Graphite Ash    Snow Ash    Brown Ash    Wenge    Marone Oak    Grey matt

**CPL\*\*)**



Norwegian Ash    Acacia    Grigio Oak    Kendal Oak    Italian Walnut    Acacia light



## ARENA

### EXECUTION STANDARD

- veneered door leaf
- peripheral frame made of softwood, reinforced with chipboard, Classen Hard for model 4
- door leaf edge profile Hard Edge R
- finishing: Classen 3D Look, Classen CPL
- 3 silver screwed pintle hinges
- lock for regular key, bathroom key, cylinder lock, mortise lock
- satin glass
- single leaf 60'-100'
- double leaf 140'-200'
- sliding single and double leaf doors

### OPTIONS FOR ADDITIONAL PAYMENT

#### VENTILATION

- ventilation undercut
- ventilation undercut 15mm (recuperation)
- ventilation sleeves PR, 3D
- ventilation sleeves - PVC with CPL, IR woodgrain foil

#### GLAZING

- satin glass bronze or graphite

#### CONSTRUCTION

- door leaf 100': + 20%

### DOOR FRAMES

- wood-based and steel door frames for rebated door



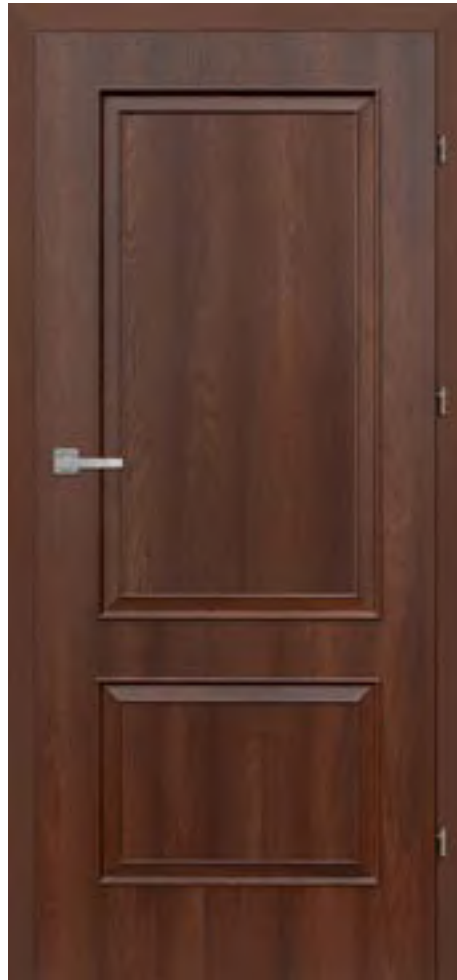

m. 1



m. 2



m. 3



m. 4



m. 5



m. 6



m. 7



Glazing beads profile

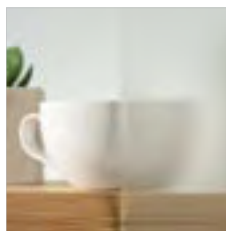

Satin glass

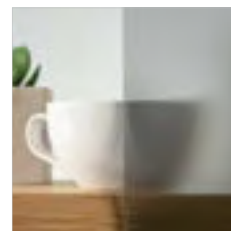

Additional payment  
Graphite satin glass

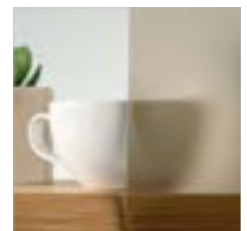

Additional payment  
Bronze satin glass

**3D Look**



Riviera Oak



White Ash



Oiled Oak



Burnt Oak



Grey Oak

**Iridium**

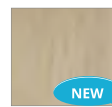

Marone Oak

**CPL**



Italian Walnut



Norwegian Ash



## CENTURY

### EXECUTION STANDARD

- veneered door leaf
- construction: stabilizing honeycomb insert, peripheral frame made of MDF
- door leaf edge profile Hard Edge R
- finishing: Classen Primo, Classen 3D Look, Classen Iridium, Classen CPL
- two silver screwed pintle hinges (leaves 100' – 3 hinges, leaves reinforced, regardless of size – 3 hinges)
- lock for regular key, bathroom key, cylinder lock, mortise lock
- satin glass
- single leaf 60'-100'
- double leaf 120'-200'
- sliding single and double leaf doors

### OPTIONS FOR ADDITIONAL PAYMENT

#### VENTILATION

- ventilation undercut
- ventilation undercut 15mm (recuperation)
- ventilation sleeves PR, 3D
- ventilation sleeves - PVC with CPL, IR woodgrain foil

#### GLAZING

- satin glass bronze or graphite

#### CONSTRUCTION

- door leaf 100': + 20%

### DOOR FRAMES

- wood-based and steel door frames for rebated door





m. 1



m. 2



m. 3



m. 4



m. 5



m. 6



m. 7



Glazing beads profile



Satin glass

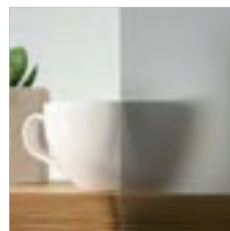

Additional payment  
Graphite satin glass

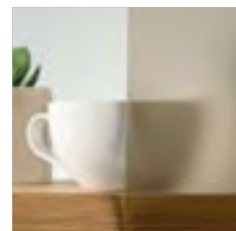

Additional payment  
Bronze satin glass

**Primo**



Acacia St

Natural Oak

Walnut

White

**3D Look**



Sonoma Oak

Riviera Oak

Light Columbia  
Walnut

White Ash



Oiled Oak

Burnt Oak

Grey Oak

**Iridium**



Anthracite Oak

Catania Oak

NEW

Graphite Ash

Snow Ash

Brown Ash

Wenge

**CPL**



Marone Oak

NEW

Grey matt

NEW

Norwegian Ash

Italian Walnut

Acacia light



Kitchen: Classen Flint floor: Classen Galaxy4V Dab Martossa D6095

## MALAGA

### EXECUTION STANDARD

- veneered door leaf
- construction: stabilizing honeycomb insert, peripheral frame made of MDF
- Hard Edge K door edge profile
- finishing: Classen Primo, Classen Iridium, Classen 3D Look
- two silver screwed pintle hinges (leaves 100' - 3 hinges, leaves reinforced, regardless of size - 3 hinges)
- lock for regular key, bathroom key, cylinder lock, mortise lock
- safety glass, toughened, white
- single leaf 60'-100'
- double leaf 120'-200'
- sliding single and double leaf doors

### OPTIONS FOR ADDITIONAL PAYMENT

#### VENTILATION

- ventilation grille
- ventilation sleeves PR, 3D
- ventilation sleeves - PVC with IR woodgrain foil

#### CONSTRUCTION

- door leaf 100': + **20%**
- third hinge
- reinforced with perforated chipboard

### DOOR FRAMES

- wood-based and steel door frames for rebated door







full



1/4 glass



2/4 glass



3/4 glass



4/4 glass



Glazing beads profile



Safety glass, toughened, white

**Primo**



Acacia St

Beech

Natural Oak

Walnut

White

Polish Oak

**3D Look**



Riviera Oak

Light Columbia Walnut

White Ash

Oiled Oak

**Iridium**



Burnt Oak

Grey Oak

Anthracite Oak

Catania Oak



Graphite Ash

Snow Ash

Brown Ash

Wenge

Marone Oak



Kitchen: Classen Flint floor: Classen Galaxy4V Dab Martossa D6095

## MODENA 4

### EXECUTION STANDARD

- veneered door leaf
- construction: stabilizing honeycomb insert, peripheral frame made of MDF
- Hard Edge K door edge profile
- finishing: Classen Primo, Classen Iridium, Classen 3D Look
- two silver screwed pintle hinges (leaves 100' – 3 hinges, leaves reinforced, regardless of size – 3 hinges)
- lock for regular key, bathroom key, cylinder lock, mortise lock
- toughened safety white glazing
- single leaf 60'-100'
- double leaf 120'-200'
- sliding single and double leaf doors

### OPTIONS FOR ADDITIONAL PAYMENT

#### VENTILATION

- ventilation grille
- ventilation sleeves PR, 3D
- ventilation sleeves - PVC with IR woodgrain foil

#### CONSTRUCTION

- door leaf 100': + 20%
- third hinge
- reinforced with perforated chipboard

### DOOR FRAMES

- wood-based and steel door frames for rebated door





full



1/4 glass



3/4 glass



4/4 glass



Glazing beads profile



Safety glass, toughened, white

**Primo**



Acacia St

Beech

Natural Oak

Walnut

White

Polish Oak

**3D Look**

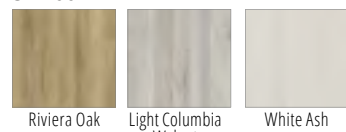

Riviera Oak

Light Columbia Walnut

White Ash



Oiled Oak

Burnt Oak

Grey Oak

Catania Oak

**Iridium**



Graphite Ash

Snow Ash

Brown Ash

Wenge

Marone Oak



floor: Classen Loft cerama Lahti 43523

## NATURA

### EXECUTION STANDARD

- veneered door leaf
- construction: stabilizing honeycomb insert, peripheral frame made of MDF
- Hard Edge K door edge profile
- finishing: Classen Primo, Classen Iridium, Classen 3D Look
- two silver screwed pintle hinges (leaves 100' – 3 hinges, leaves reinforced, regardless of size – 3 hinges)
- lock for regular key, bathroom key, cylinder lock, mortise lock
- ornamental glass, transparent bark
- horizontal slat
- single leaf 60'-100'
- double leaf 120'-200'
- sliding single and double leaf doors

### OPTIONS FOR ADDITIONAL PAYMENT

#### VENTILATION

- ventilation grille
- ventilation sleeves PR, 3D
- ventilation sleeves - PVC with CPL, IR woodgrain foil

#### CONSTRUCTION

- door leaf 100': + 20%
- third hinge
- reinforced with perforated chipboard

### DOOR FRAMES

- wood-based and steel door frames for rebated door





full



1/3 glass



2/3 glass



3/3 glass



Glazing beads profile



Ornament glass

\*) only full model

**Primo**



Acacia St

Beech

Natural Oak

Walnut

White

Polish Oak

**3D Look**

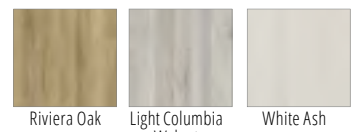

Riviera Oak

Light Columbia  
Walnut

White Ash

**Iridium**

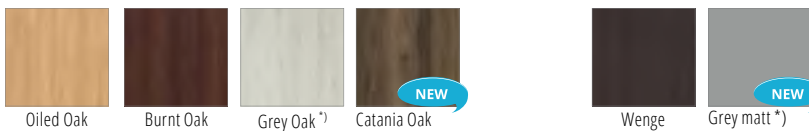

Oiled Oak

Burnt Oak

Grey Oak ^)

Catania Oak

NEW



Wenge



Grey matt \*)

NEW



floor: Classen Forest Salerno Oak 43523

## ANTIOPE

### EXECUTION STANDARD

- veneered door leaf
- construction: stabilizing honeycomb insert, peripheral frame made of MDF
- door leaf edge profile Hard Edge R
- finishing: Classen Primo, Classen 3D Look
- two silver screwed pintle hinges (leaves 100' – 3 hinges, leaves reinforced, regardless of size – 3 hinges)
- lock for regular key, bathroom key, cylinder lock, mortise lock
- toughened safety white glazing
- single leaf 60'-100'
- double leaf 120'-200'
- sliding single and double leaf doors

### OPTIONS FOR ADDITIONAL PAYMENT

#### VENTILATION

- ventilation grille
- ventilation sleeves PR, 3D

#### CONSTRUCTION

- door leaf 100': + 20%
- third hinge

#### DOOR FRAMES

- wood-based and steel door frames for rebated door





m. 1



m. 2



m. 3



Glazing beads profile



Safety glass, toughened, white

**Primo**



Acacia St



Natural Oak



Walnut

**3D Look**



Riviera Oak



White Ash



Burnt Oak



Grey Oak



Anthracite Oak



## KSANTOS NEW

### EXECUTION STANDARD

- veneered door leaf
- construction: stabilizing honeycomb insert, peripheral frame made of MDF
- door leaf edge profile Hard Edge R
- finishing: Classen Primo, Classen 3D Look
- two silver screwed pintle hinges (leaves 100' - 3 hinges, leaves reinforced, regardless of size - 3 hinges)
- lock for regular key, bathroom key, cylinder lock, mortise lock
- toughened safety white glazing
- single leaf 60'-100'
- double leaf 120'-200'

### OPTIONS FOR ADDITIONAL PAYMENT

#### VENTILATION

- ventilation grille
- ventilation sleeves PR, 3D

#### CONSTRUCTION

- door leaf 100': + 20%
- third hinge

#### DOOR FRAMES

- wood-based and steel door frames for rebated door







m.1



m.2



m.3



m.4



Glazing beads profile

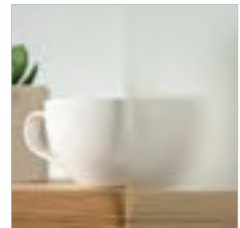

Satin glass

**Primo**



Acacia St



White



Polish Oak

**3D Look**



Riviera Oak



White Ash



Burnt Oak



## TEMIDA

### EXECUTION STANDARD

- veneered door leaf
- construction: stabilizing honeycomb insert / peripheral frame made of MDF
- Hard Edge K door edge profile
- finishing: Classen Primo, Classen 3D Look
- two silver screwed pintle hinges (leaves 100' - 3 hinges, door leaves reinforced, regardless of size - 3 hinges)
- standard key lock, cylinder lock bathroom lock,
- satin glass
- single leaf 60'-100'
- double leaf 120'-200'
- sliding single and double leaf doors

### OPTIONS FOR ADDITIONAL PAYMENT

#### VENTILATION

- ventilation sleeves PR, 3D

#### CONSTRUCTION

- door leaf 100': + 20%
- third hinge

### DOOR FRAMES

- wood-based and steel door frames for rebated door





full



1/3 glass



3/3 glass



Glazing beads profile

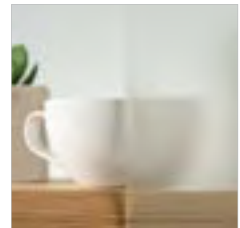

Satin glass

**Primo**



Acacia St



Walnut

**3D Look**



Sonoma Oak

functionality and aesthetics  
HIGH QUALITY



# TECHNICAL DOORS

They represent the highest standard of performance and the best technical parameters. Their quality is confirmed by numerous approvals. Depending on the collection, they perform different functions: provide good sound insulation, fire protection, anti-burglary properties. Their common feature is a reinforced structure using materials of increased strength and durability. They are proof that functionality can go hand in hand with aesthetics. It's an excellent choice for public spaces, including offices, hotels, gastronomic and service premises. This group also includes entrance doors intended for use in residential and commercial buildings.



## FUNCTIONALITY OR NICE APPEARANCE?

You don't have to choose. No more compromises. Our technical doors have everything - excellent usability and aesthetics pleasing to the eye.

## FOR THE OFFICE, HOTEL AND RESTAURANT.

Wherever high quality, good technical parameters and solid workmanship are important. Choose a door that will not let you down. Ideal for public utility buildings.





floor: Classen Sono - Forest Opal Wood 41071

## NATURA HK CPL / HB CPL

### EXECUTION STANDARD

- veneered door leaf
- construction Classen Hard (not applicable version PN22 i PN23)
- wide stile for version PN22 i PN23
- Natura HK CPL (Hard Edge K), Natura HB CPL (non-rebated)
- finishing: Classen CPL
- HK: two silver screwed pintle hinges (leaves 100' – 3 hinges, leaves reinforced, regardless of size – 3 hinges)
- HB: two openings for hinges for non-rebated door
- lock for regular key, bathroom key, cylinder lock, mortise lock (HB - magnetic lock)
- toughened safety white glazing
- single leaf: 60'-120'
- double leaf: 120'-200' (does not apply to HB)
- sliding single and double leaf doors
- prepared for shortening by 40mm

### DOOR FRAMES

#### HB:

- steel fixed non-rebated door frame - **page 129**
- adjustable non-rebated door frame - **page 128**

#### HK:

- steel adjustable door frame - **page 127**
- steel fixed door frame - **page 129**
- standard 2-PACK door frame - **page 124**
- adjustable door frame - **page 120**

### OPTIONS FOR ADDITIONAL PAYMENT

#### VENTILATION

- ventilation undercut
- ventilation undercut 15mm (recuperation)
- ventilation sleeves - PVC with CPL woodgrain foil
- ventilation grille PVC: white, grey, brown, beige
- ventilation grille, aluminium
- bottom steel panel with ventilation

#### GLAZING

- bullseye 35 tr - transparent glass
- bullseye 35 ml - white glass

#### CONSTRUCTION

- third hinge
- perforated chipboard\*)
- full chipboard\*\*)
- non-rebated door leaf (HB)
- door leaf 100': + **20%**
- door leaf 110': + **30%**
- door leaf 120': + **35%**
- door leaf model PN22 + **35%**
- door leaf model PN23 + **40%**

#### ACCESSORIES

- top full steel panel - single-sided
- top full steel panel - double-sided
- bottom full steel panel - single-sided
- bottom full steel panel - double-sided
- falling threshold



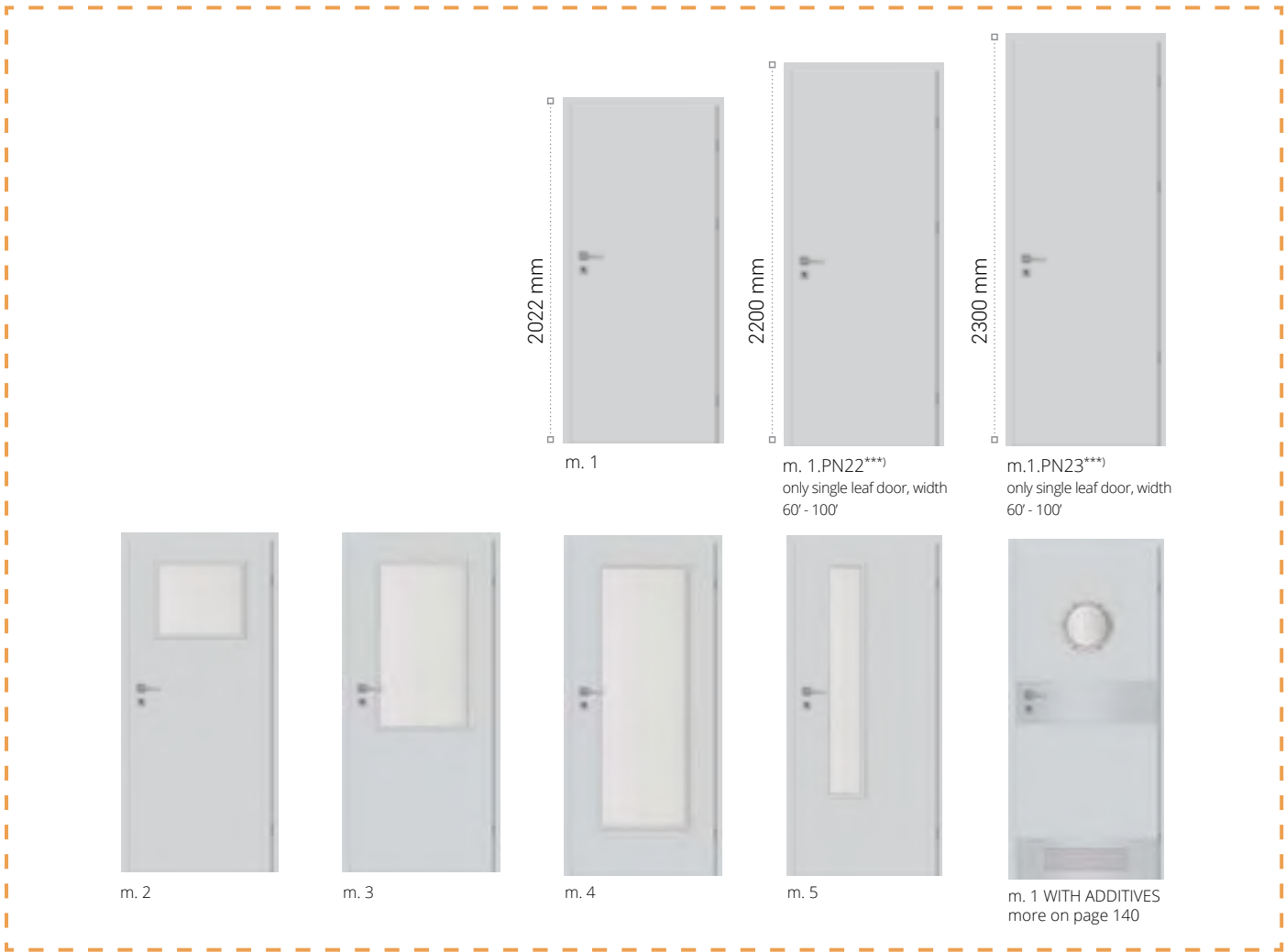

m. 2



m. 3



m. 4



m. 5



m. 1 WITH ADDITIVES  
more on page 140

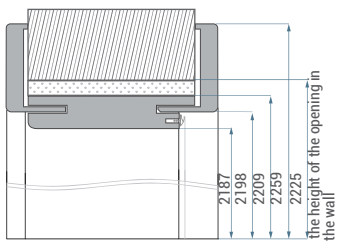

Wymiary ościeznica do door PN22

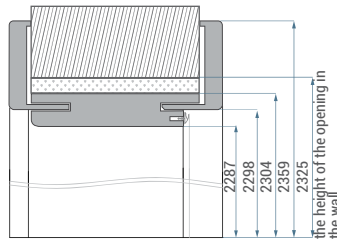

Wymiary ościeznica do door PN23



Glazing beads profile



safety glass, toughened,  
white

\*) Max. door leaf width 110'

\*\*) Max. door leaf width 100'

\*\*\*) PN22 and PN23 models are not available in non-rebated version as well as with the following door frames: Adjustable 80, Standard 2 pack, steel door frame.

CPL





## NATURA HK HPL / HB HPL

### EXECUTION STANDARD

- veneered door leaf
- construction Classen Hard
- Natura HK HPL (Hard Edge K), Natura HB HPL (non-rebated)
- finishing: Classen HPL
- HK: two silver screwed pintle hinges (leaves 100' – 3 hinges, leaves reinforced, regardless of size – 3 hinges)
- HB: two openings for hinges for non-rebated door
- lock for regular key, bathroom key, cylinder lock, mortise lock (HB - magnetic lock)
- toughened safety white glazing
- single leaf: 60'-120'
- double leaf: 120'-200' (does not apply to HB)
- sliding single and double leaf doors
- prepared for shortening by 40mm

### DOOR FRAMES

#### HB:

- steel fixed non-rebated door frame - **page 129**
- adjustable non-rebated door frame - **page 128**

#### HK:

- steel adjustable door frame - **page 127**
- steel fixed door frame - **page 129**

### OPTIONS FOR ADDITIONAL PAYMENT

#### VENTILATION

- ventilation undercut
- ventilation undercut 15mm (recuperation)
- ventilation grille PVC: white, grey, brown, beige
- ventilation grille, aluminium
- bottom steel panel with ventilation

#### GLAZING

- bullseye 35 tr - transparent glass
- bullseye 35 ml - white glass

#### CONSTRUCTION

- third hinge
- perforated chipboard<sup>\*)</sup>
- full chipboard<sup>\*\*)</sup>
- non-rebated door leaf (HB)
- door leaf 100': + **20%**
- door leaf 110': + **30%**
- door leaf 120': + **35%**

#### ACCESSORIES

- top full steel panel - single-sided
- top full steel panel - double-sided
- bottom full steel panel - single-sided
- bottom full steel panel - double-sided
- falling threshold





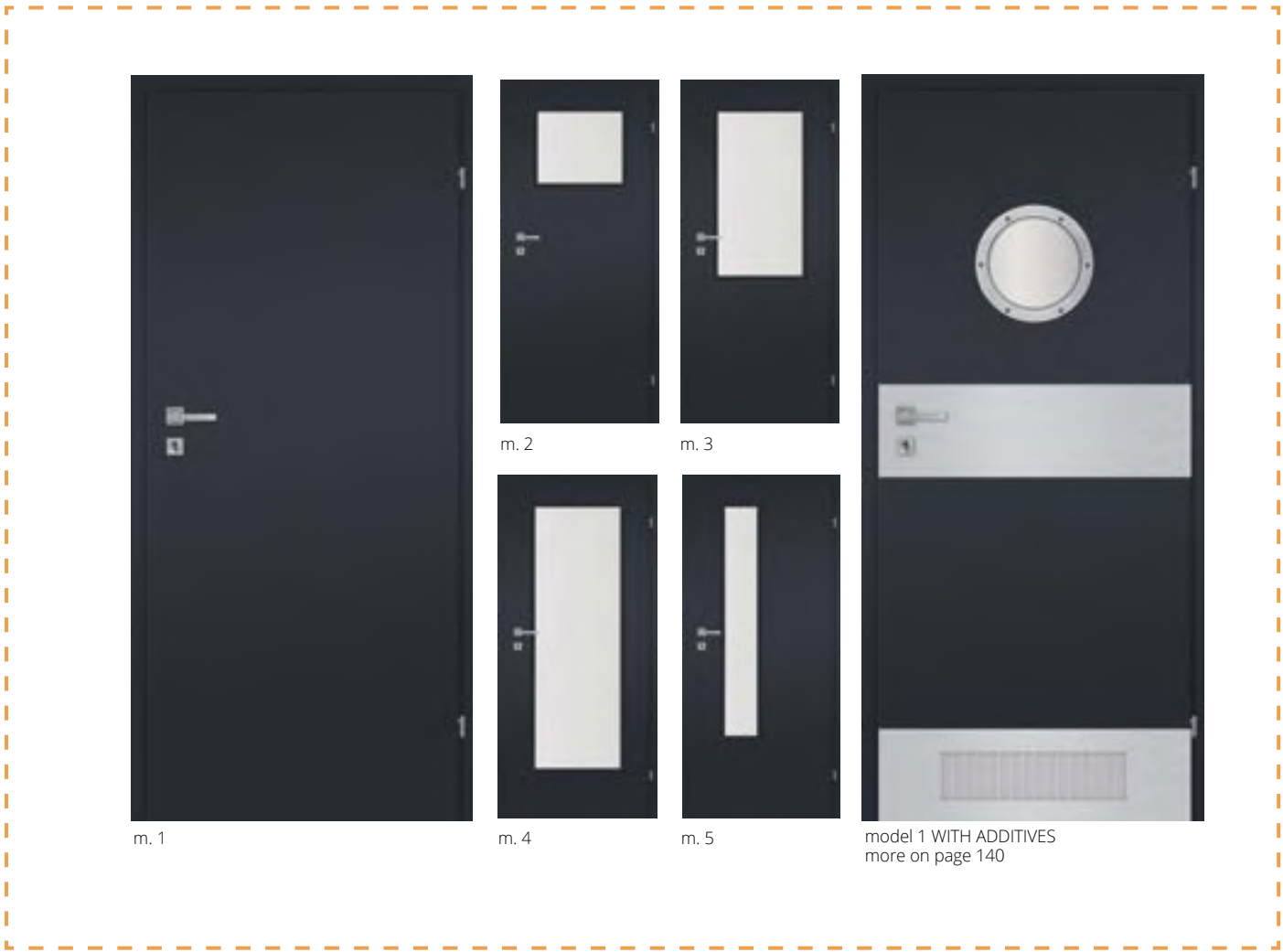

m. 1

m. 2

m. 3

m. 4

m. 5

model 1 WITH ADDITIVES  
more on page 140



Glazing beads profile



Safety glass, toughened,  
white

\*) Max. door leaf width 110"

\*\*\*) Max. door leaf width 100"

Due to the type of material used, a difference in shades between door leaf surface, window frame and door frame may occur.

**HPL**

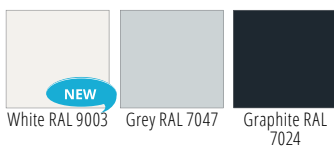

Other HPL decors (page 152) available upon individual enquiries.  
(Decors outside the standard range are offered with the rebate in brushed aluminum colour).



## GUARD

### EXECUTION STANDARD

- veneered door leaf
- reinforced structure plus, door leaf thickness - 40mm
- door leaf edge protected with stainless steel profile
- window frame made of stainless steel
- surface finishing: Classen HPL laminate, thickness 0.8 mm
- reinforced three silver screwed pintle, three-way hinges
- safety glass, toughened, white, thickness: 4 mm
- lock for cylinder lock
- single leaf door: 60'-110'
- reinforcement for door closer

### DOOR FRAMES

- steel frame, fixed and adjustable GUARD

### OPTIONS FOR ADDITIONAL PAYMENT

#### VENTILATION

- ventilation grille PVC: White, grey, brown, beige
- ventilation grille, aluminiowa
- panel stalowy dolny z wentylacją

#### CONSTRUCTION

- door leaf 100': + **10%**
- door leaf 110': + **15%**

#### ACCESSORIES

- top full steel panel - single-sided
- top full steel panel - double-sided
- bottom full steel panel - single-sided
- bottom full steel panel - double-sided



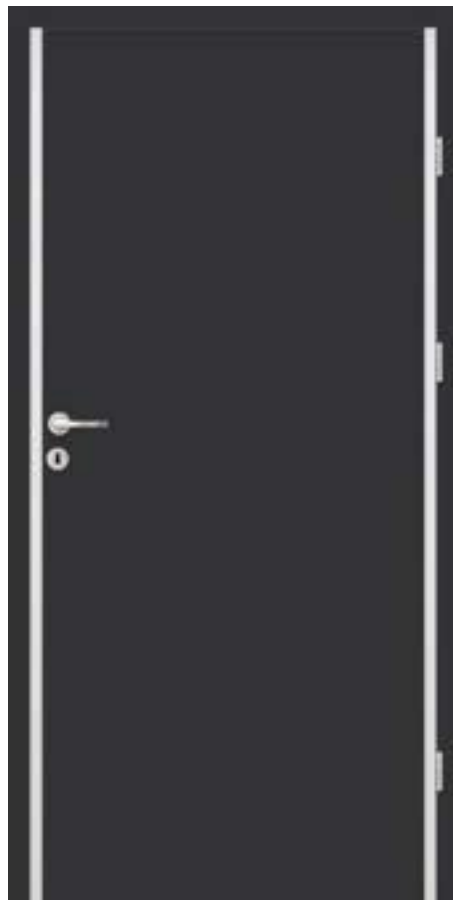

m.1



m.2



m.3



m.4



m.5

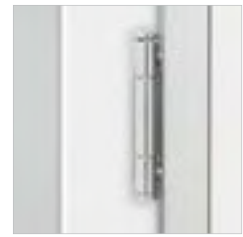

Three-way hinge

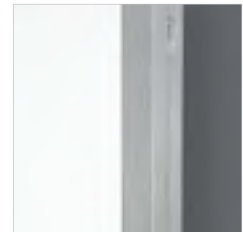

Door leaf rebate protected with stainless steel profile



Bullseye

CPL



HPL

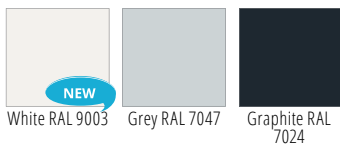

Other HPL decors (page 152), all CPL decors (page 151) available upon individual enquiries.  
(Decors outside the standard range are offered with the rebate in brushed aluminum colour).

Additional information:  
- possibility of executing custom door leaves, door frames and glasses upon individual requests.



## BORD

### EXECUTION STANDARD

BORD internal entrance door is designed for use in residential housing, public utility and collective residential buildings as the internal entrance door.

- veneered door leaf
- acoustic resistance - 32 dB for B 46 W2 and W46 W2 door
  - when using door frame BORD MDF
  - when using steel fixed door frame
- Hard Edge K door leaf edge profile
- finishing: Classen Primo, Classen 3D Look, Classen Iridium laminate, Classen CPL laminate
- three silver screwed double-pin pintle hinges, adjustable
- single leaf 80'-100'
- door leaves thickness: B40 – 40 mm, B46 and W46 – 46 mm

### REMARKS

- lock openings spacing:
  - bottom bolt – 90 mm (B)
  - multipoint – 72 mm (W)
- cylinder locks and door handles do not constitute door leaf equipment
- cylinder lock size: B40 – 26/36, B46 and W46 – 26/41
- technical approval: AT – 15-8467/2016

### OPTIONS FOR ADDITIONAL PAYMENT

#### FINISHING

- Classen HPL laminates

#### CONSTRUCTION

- door leaf and door frames 100': + **20%**

#### ACCESSORIES

- peephole
- falling threshold
- steel panel with room's number - single-sided

### DOOR FRAMES

#### COLLECTION AVAILABLE IN A SET WITH DOOR FRAMES:

- BORD MDF - **page 132**
- BORD steel fixed door frame - **page 131**
- BORD steel corner door frame - **page 130**
- HYBRID - **page 126**

### OPTIONS FOR ADDITIONAL PAYMENT

Additional information: possibility of executing custom door leaves, door frames and glasses upon individual requests.





m.1



Steel panel with room's number (option), more info on [page 140](#)



Bottom bolt lock



Top bolt lock



Anti-burglary bolt



Falling threshold

BORD	B40 W1	B46 W1	B46 W2	W46 W1	W46 W2
reinforced peripheral frame made of softwood	✓	✓	✓	✓	✓
steel flat bars		✓	✓	✓	✓
perforated chipboard	✓	✓	✓	✓	✓
two bolt locks for cylinder lock	✓	✓	✓		
multipoint lock for cylinder lock				✓	✓
falling threshold an three anti-burglary bolts			✓		✓

Primo



3D Look



Iridium



CPL

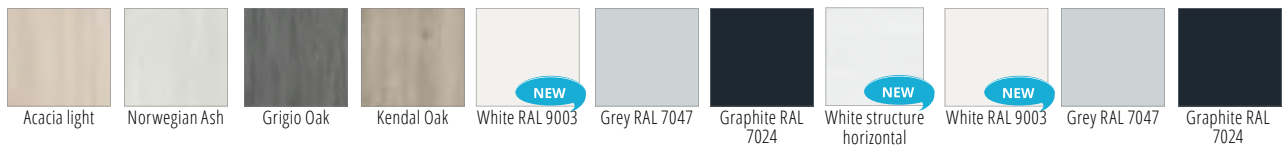

Other HPL decors (page 152) available upon individual enquiries.  
 (Decors outside the standard range are offered with the rebate in brushed aluminum colour).

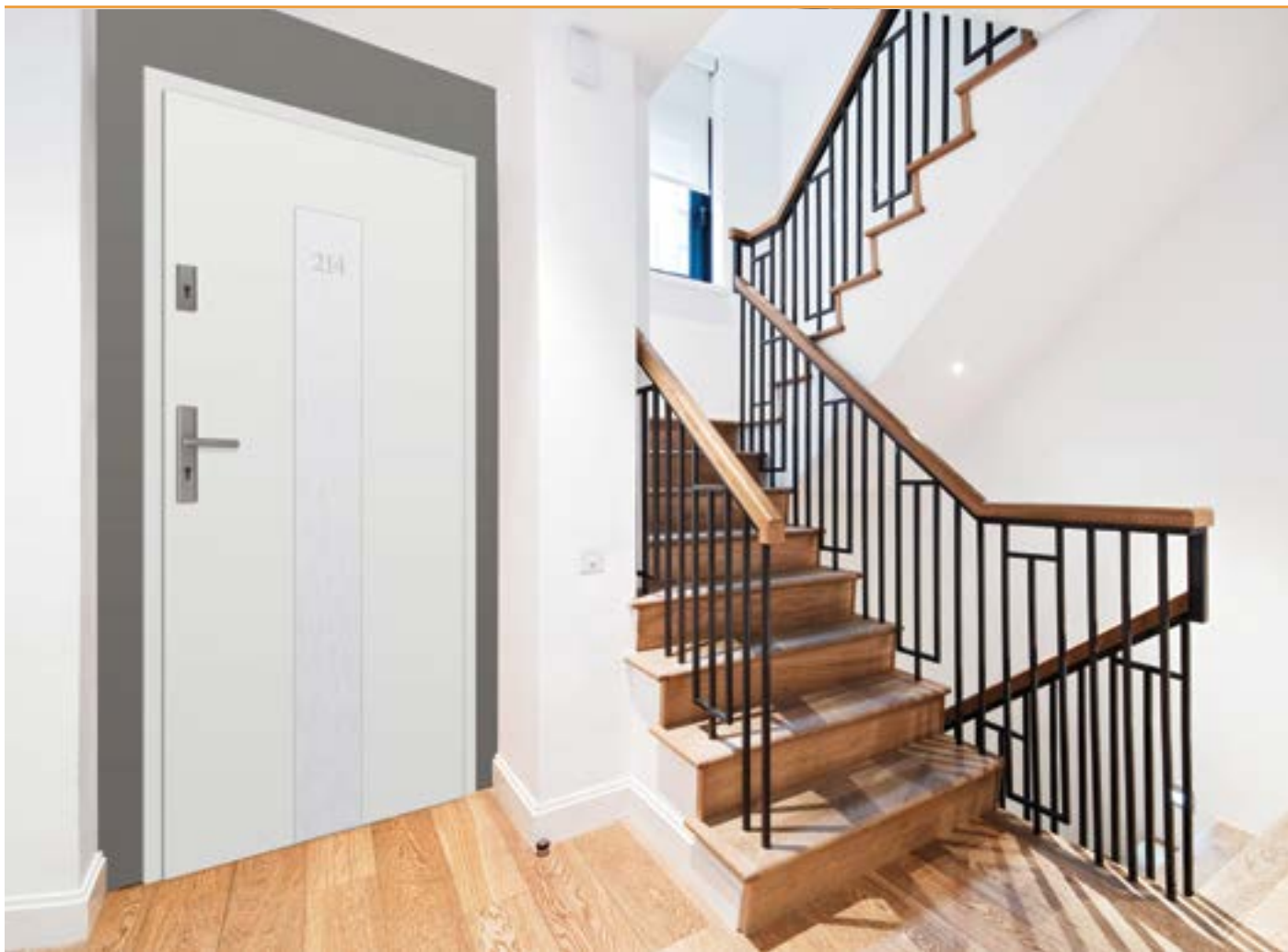

## BORD W3

BORD W3 internal entrance door meet the requirements of RC2 class anti-burglary protection, under the condition of installing the door with special steel door frame, handle with escutcheon (**page 146**) and a set of cylinder locks fulfilling the second anti-burglary class (**page 144**).

### CONSTRUCTION

Construction of a door leaf with thickness of 46mm: peripheral frame made of softwood reinforced with special steel flat bar and a plywood. As a filling, a perforated chipboard was used. All is covered with wood-based board, veneered with Classen decors.

### EXECUTION STANDARD

- veneered door leaf
- finishing: Classen Primo, Classen Iridium, Classen CPL laminate and Classen HPL laminate
- Hard Edge K door leaf edge profile
- three silver anti-burglary three-way hinges
- Multistrong anti-burglary strip
- multipoint lock for cylinder lock (openings spacing 72mm)
- single leaf 80'-100'
- door leaves thickness: 46 mm
- door leaf available only with BORD W3 steel fixed door frame - **page 131**

### OPTIONS FOR ADDITIONAL PAYMENT

#### CONSTRUCTION

- door leaf i ościeżnice 100': + **20%**

#### ACCESSORIES

- peephole
- fixed threshold
- falling threshold
- steel panel with room's number - single-sided





m.1



Full with steel panel with room's number (option), more on **page 140**



Three-way hinge

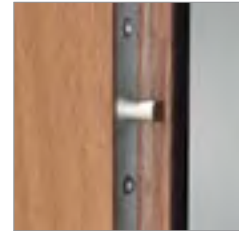

Plate with anti-burglary bolts



Multipoint lock

**Primo**



Acacia St Beech Natural Oak Walnut White

**3D Look**



Riviera Oak Light Columbia Walnut White Ash Oiled Oak Burnt Oak

**Iridium**

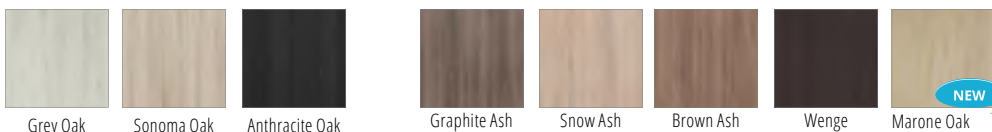

Grey Oak Sonoma Oak Anthracite Oak Graphite Ash Snow Ash Brown Ash Wenge Marone Oak

**CPL**

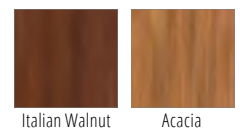

Italian Walnut Acacia

**HPL**

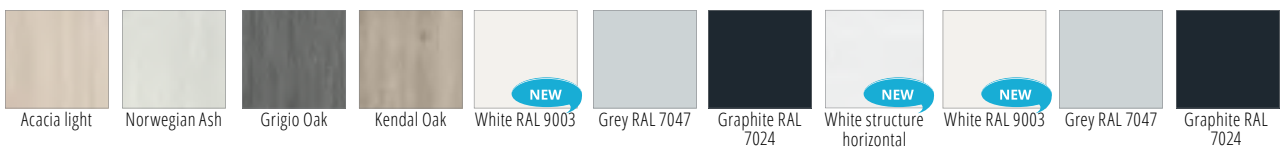

Acacia light Norwegian Ash Grigio Oak Kendal Oak White RAL 9003 Grey RAL 7047 Graphite RAL 7024 White structure horizontal White RAL 9003 Grey RAL 7047 Graphite RAL 7024

Other HPL decors (page 152) available upon individual enquiries.  
 (Decors outside the standard range are offered with the rebate in brushed aluminum colour).



## DOOR EI30 42dB

### FIRE DOOR EI30 42dB

- Veneered door leaf,
- Construction: softwood peripheral frame with filling made of specialized board. Covered with HDF board
- Cylinder lock, openings spacing 72 mm
- Single leaf 60' - 90'
- Falling threshold
- Classen finishing: Iridium, CPL, HPL
- Expanding seals
- Mechanical resistance class 3 (according to PN-EN 1192:2001)

#### rebated door leaf:

- Hard Edge K door edge profile
- 4 pintle hinges
- Additional seal in the rebate
- Dedicated door frame: Fixed MDF 42dB

#### non-rebated door leaf:

- Hard Edge B door leaf edge profile
- 4 hidden hinges
- Dedicated door frame: Fixed non-rebated MDF 42dB

### OPTIONS FOR ADDITIONAL PAYMENT

- Top full steel panel - single-sided
- Top full steel panel - double-sided
- Bottom full steel panel - single-sided
- Bottom full steel panel - double-sided
- Venom alu
- Milling for hidden door closer in non-rebated version without additional payment

### ACOUSTIC DOORS 42dB

- Veneered door leaf,
- Construction: softwood peripheral frame with filling made of specialized board. Covered with HDF board
- Cylinder lock, openings spacing 72 mm
- Single leaf 60' - 90'
- Falling threshold
- Classen finishing: Iridium, CPL, HPL
- Mechanical resistance class 3 (according to PN-EN 1192:2001)

#### rebated door leaf:

- Hard Edge K door edge profile
- 4 pintle hinges
- Additional seal in the rebate
- Dedicated door frame: Fixed MDF 42dB

#### non-rebated door leaf:

- Hard Edge B door leaf edge profile
- 4 hidden hinges
- Dedicated door frame: Fixed non-rebated MDF 42dB

### ADDITIONAL INFORMATION:

- National technical approval: ITB-KOT-2019/0407, 1st edition
- Door can be used as entrance
- In order to fulfill KOT requirements, fire door must be bought with a self-closer







fire rebated - Ei30 42 dB /  
rebated - 42 dB



profile - rebated



lock - rebated door



pintle hinge



profile - non-rebated



lock - non-rebated



hidden hinge



DC 135 door closer with slide rail



DC 840 covered door closer with slide rail  
for non-rebated door leaf



falling threshold

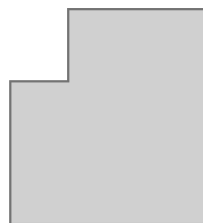

rebate profile - non-rebated door

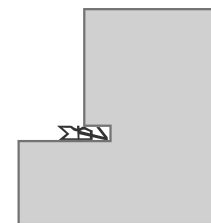

rebate profile - rebated door

\*) **Acoustic**  
rebated: D1-40; D2-35; Rw=42dB  
non-rebated: D1-35; D2-35; Rw=42dB

\*\*) **HPL decors:** door frames for HPL decors available in Iridium or CPL veneer. Colour differences regarding the shade are permissible.

**Iridium**



Graphite Ash

Snow Ash

Brown Ash

Wenge

Marone Oak

**CPL**

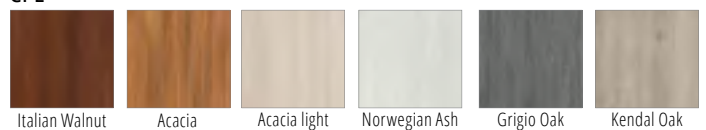

Italian Walnut

Acacia

Acacia light

Norwegian Ash

Grigio Oak

Kendal Oak

**HPL<sup>1)</sup>**

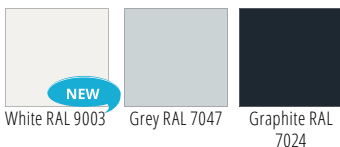

White RAL 9003

Grey RAL 7047

Graphite RAL 7024

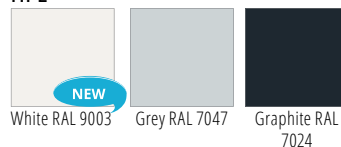

White RAL 9003

Grey RAL 7047

Graphite RAL 7024

Other HPL decors (page 152) available upon individual enquiries. (Decors outside the standard range are offered with the rebate in brushed aluminum colour).



floor: Classen Neo 2.0 - S18 Mineral Slate 40813

## FIRE DOOR EI30 / EI60

### EXECUTION STANDARD

- veneered door leaf
- special two-layer board / peripheral frame made of softwood
- mortise latch lock for cylinder lock with insulation insert
- falling threshold - version W2
- Hard Edge K door leaf edge profile
- surface finishing: Classen Iridium, Classen CPL laminate, Classen HPL laminate
- swelling gasket in door leaf rebate
- four silver pintle hinges
- single leaf 80'-100' - acoustic resistance = 32 dB version W2
- double leaf 120'-200' - acoustic resistance = 27 dB for EI30 and 32 dB for EI60 version W2
- door leaves thickness: EI30 - 50 mm, EI60 - 60 mm
- in glazed version: transparent glass with higher fire proof class
- lock openings spacing 72 mm
- in the door EI30 is available the smoke proof version with the steel fixed door frame

### INTERNAL FIRE DOOR LEAF

Internal entrance fire door, designed for use in residential housing, public utility and collective residential buildings as the door fulfilling the requirements for fire resistance class EI30 or EI60, smoke proof class  $S_a$  and  $S_m$  and acoustic resistance up to 32dB.

### DOOR FRAMES

- FIRE wooden door frame - [page 135](#)
- FIRE steel fixed door frame - [page 135](#)



### ADDITIONAL INFORMATION

- **Version W1** - does not have  $S_a$ ,  $S_m$  smoke proof class and acoustic resistance (falling threshold)
- National Technical Assessment ITB-KOT-2018/0407, 1st edition
- certificates of conformity: ITB No. 020-UWB-2697/W
- in order to meet National Technical Assessment's requirements, fire doors must be purchased together with a door closer
- internal entrance door only in full version
- cylinder locks and door handles do not constitute door leaf equipment
- cylinder locks size: EI 30 - 36x36; EI 60 - 36x46 (for handle escutcheons with a thickness of approx. 10mm)
- possibility to execute custom width and height of single and double door leaves upon individual enquiry

### OPTIONS FOR ADDITIONAL PAYMENT

#### FINISHING

- Classen HPL laminate

#### CONSTRUCTION

- door leaf and door frames 100': **+ 5%**
- door leaf and door frames 110': **+ 20%**

#### ACCESSORIES

- steel threshold
- falling threshold
- top full steel panel - single-sided
- top full steel panel - double-sided
- bottom full steel panel - single-sided
- bottom full steel panel - double-sided
- steel panel with room's number - single-sided



full - EI30 or EI60



with glass - EI30 or EI60



with glass EI30 m. 1



with glass EI60 m. 1



with glass with bottom steel panel (option), more on **page 140**



steel panel with room's number (option), more on **page 140**



Falling threshold



DC135 door closer with slide rail



DC140 surface-mounted door closer with standard arm

\*) **HPL decors:** door frames for HPL decors available in Iridium or CPL veneer. Colour differences regarding the shade are permissible..

**Iridium**



Graphite Ash

Snow Ash

Brown Ash

Wenge

Marone Oak

**CPL**

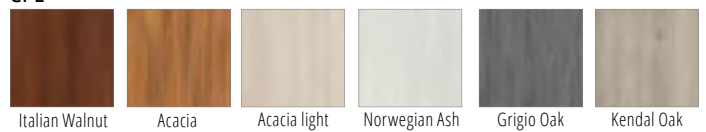

Italian Walnut

Acacia

Acacia light

Norwegian Ash

Grigio Oak

Kendal Oak

**HPL<sup>1)</sup>**



White RAL 9003

Grey RAL 7047

Graphite RAL 7024

White structure horizontal

White RAL 9003

Grey RAL 7047

Graphite RAL 7024

Other HPL decors (page 152) available upon individual enquiries. (Decors outside the standard range are offered with the rebate in brushed aluminum colour).



## VENOM

▼ optional milling patterns available for BORD and FIRE collections



m. 3



m. 4



m. 5



m. 6



m. 7



m. 8



m. 9



m. 10



m. 11



m. 13



m. 14





#### REMARKS

Available for additional payment for full models from BORD, BORD W3 and FIRE collections.

#### Primo



Acacia St

#### 3D Look

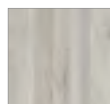

Light Columbia Walnut



Oiled Oak



Burnt Oak



Sonoma Oak

#### Iridium



Wenge



floor: Classen Visiogrande Concrete beige L3757

## VENOM ALU

### REMARKS

Available for additional payment for full models from the following collections: BORD, BORD W3, FIRE, Natura HK/HB CPL, Natura HK/HB HPL, Natura HR (in selected decors).



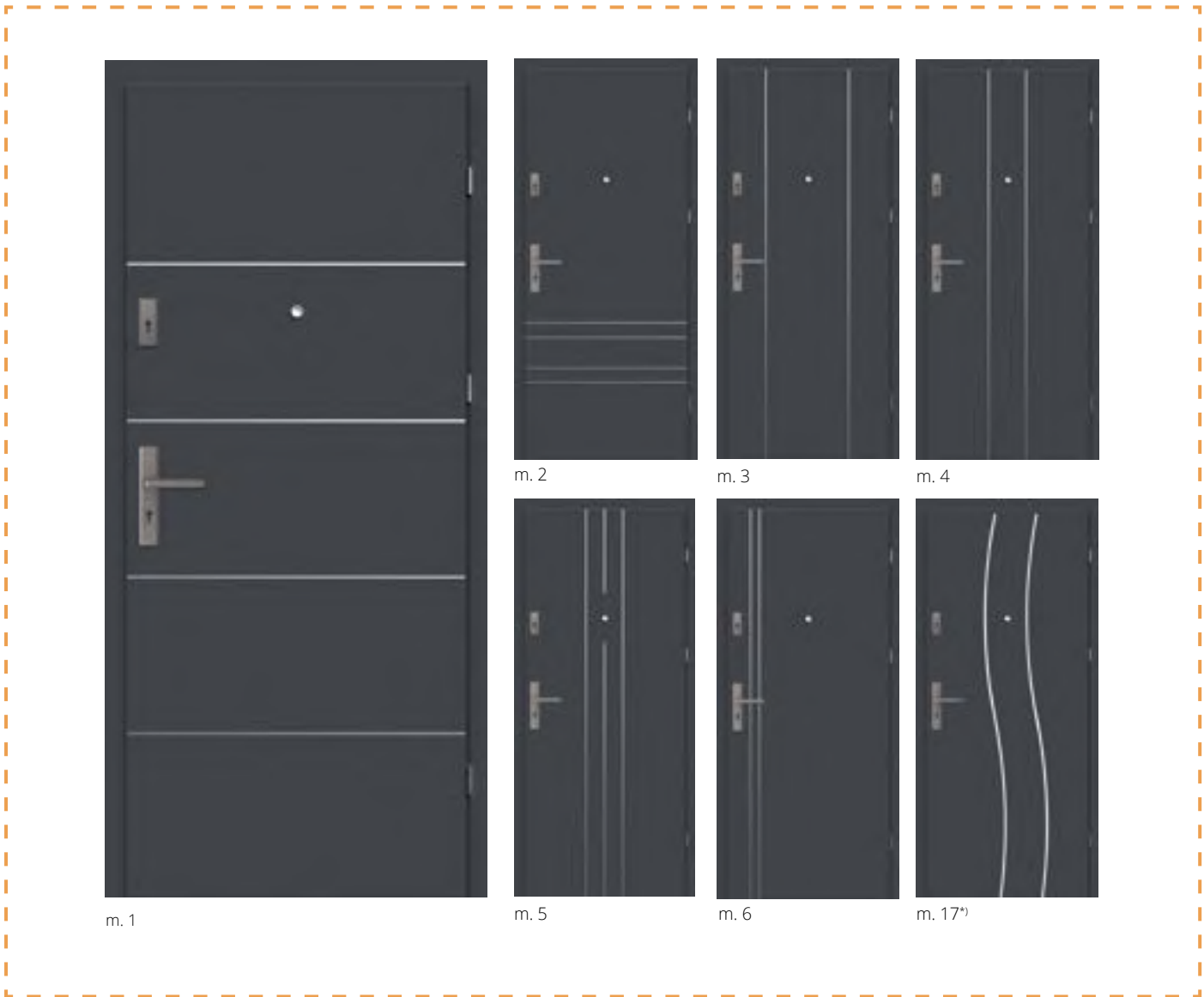

Aluminium profile\*\*)

\*) Available without color CPL White RAL 9010 i Grey RAL 7047.  
 \*\*) Aluminium profile, width: 8mm (colour - stainless steel / INOX), aligned with a door leaf surface.

**Iridium**



**CPL**

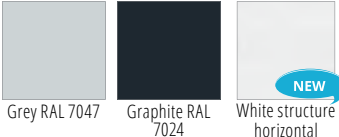

**HPL**

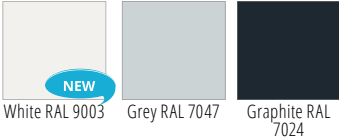



## ACOUSTIC DOORS

### ACOUSTIC DOORS - full 27 dB - Rw (27-30)

- veneered door leaf full
- construction: perforated chipboard, peripheral frame made of softwood, covered with HDF board - Hard Edge K door edge profile
- finishing: Classen Primo, Classen Iridium, Classen 3D Look, Classen CPL, HPL laminate and lacquered
- 3 silver pintle hinges
- lock for regular key, bathroom key, cylinder lock, mortise lock
- falling threshold
- single leaf 60'-90' (100' - additional payment 20%)

**Dedicated door frames:**

Rw (C; Ctr)= 30(-1; -1) dB - Adjustable door frame

### ACOUSTIC DOORS - full 32 dB - Rw (32-34)

- veneered full door leaf
- construction: specialized board, peripheral frame made of softwood, covered with HDF board - Hard Edge K door edge profile
- finishing: Classen Primo, Classen 3D Look, Classen Iridium, Classen CPL, HPL laminate and lacquered
- 3 silver pintle hinges
- lock for regular key, bathroom key, cylinder lock, mortise lock
- falling threshold
- single leaf 60'-90' (100' - additional payment 20%)

**Dedicated door frames:**

Rw (C; Ctr)= 34(-1; -2) dB - Adjustable door frame

Rw (C; Ctr)= 32(0; -1) dB - Steel fixed door frame

### ACOUSTIC DOORS - with glass 32 dB - Rw (32-33)

- veneered door leaf with glass
- construction: specialized board, peripheral frame made of softwood, covered with HDF board
- transparent safety glass
- door leaf Hard Edge profile K
- finishing: Classen Primo, Classen 3D Look, Classen Iridium, Classen CPL, HPL laminate and lacquered
- 3 silver pintle hinges
- lock for regular key, bathroom key, cylinder lock, mortise lock
- falling threshold
- single leaf 60'-90' (100' - additional payment 20%)

**Dedicated door frames:**

Rw (C; Ctr)= 32(0; -2) dB - Adjustable door frame

Rw (C; Ctr)= 33(0; -2) dB - Steel fixed door frame

### ADDITIONAL INFORMATION

- acoustic resistance 27 dB (27-30 dB). Report from GLA-1144.3/13 examinations.
- acoustic resistance 32 dB (32-34 dB). Report from GLA-1166.2/14 examinations.







full - 27 dB



m. 1 - 32 dB



m. 2 - 32 dB



m.3 - 32 dB



Classen acoustic doors are available in all decors from the following groups (details page 150-151) and optionally in the colours from RAL palette.



unconventional, surprising  
**ORIGINAL SOLUTIONS**

# DOORS ALIGNED WITH THE WALL

Chameleon among the doors. No door frames, hidden door frame and hinges, and a door leaf that perfectly merges with the wall - together they open up endless possibilities of personalization. DIYers, artistic souls and people seeking original solutions cannot pass by indifferently. The primed surface of the leaf is like a clean canvas that encourages the imagination and decorating it according to your own idea and vision. By choosing the identical finish of the wall and door, you can create a kind of secret passage. Only the door handle will reveal its presence in the interior. Ready to experiment?



## ARTISTIC SPACE.

The trick is to organize four walls so that they inspire and encourage you to stay inside for longer. The key to achieve this goal is the Compact door, finished according to your vision.

UNCONVENTIONAL SOLUTIONS.  
Compact doors stimulate the imagination and encourage creative thinking. Ideally suited to modern interiors, both the small and the large ones.





floor: Classen Villa 4V L3750

## COMPACT

The Compact system consists of interior door leaf, veneered or for self-finishing and an aluminium door frame. After assembly, all elements constitute an aligned surface with the wall.

### EXECUTION STANDARD

- boarded door leaf, full, thickness: 40 mm
- Classen Hard structure
- external door leaf - non-rebated, outward opening (height 2022 mm)
- internal door leaf - rebated, inward opening (height 2032 mm)
- surface finishing: primed (surface prepared for self-finishing, e.g. painting\*), 3D Look and Iridium veneers, CPL and HPL laminates
- single leaf 60'-100'
- two openings for hidden hinges, adjustable (3 hinges for the width of 100' and height from 2222 to 2332 mm)
- magnetic lock for regular key, mortise lock, bathroom key, cylinder lock

\* tests conducted using original wall paints available on the market

### OPTIONS FOR ADDITIONAL PAYMENT

#### VENTILATION

- ventilation undercut
- ventilation undercut 15mm (recuperation)

#### CONSTRUCTION

- perforated chipboard
  - width 100': **+20%**
  - height 2132, 2122 mm: **+30%**
  - height 2232, 2222 mm: **+35%**
  - height 2332, 2322 mm: **+40%**
- Additional payment for width and height apply to the door leaf and the frame.

#### ACCESSORIES

- falling threshold

### DOOR FRAMES

Aluminium door frame, available in **internal** and **external** version, raw, with a possibility of self-painting after previous impregnation.

The package includes: 2 or 3 hinges, gaskets, impregnating agent, installation instruction and accessories necessary for its installation. Installation of the frame on a raw wall requires application of plaster or plaster-cardboard panels.



## INTERNAL DOOR FRAME

Door leaf height Hd	Installation opening height Ho	Door leaf external height Hz	Clear opening height Hp	Amount of hinges
2032	2081	2074	2032	2
2132	2181	2174	2132	2
2232	2281	2274	2232	3
2332	2381	2374	2332	3
Door leaf height Sd	Installation opening height So	Door leaf external height Sz	Width in the door frame clear opening Sp	
618	698	688	603	
718	798	788	703	
818	898	888	803	
918	998	988	903	
1018	1098	1088	1003	

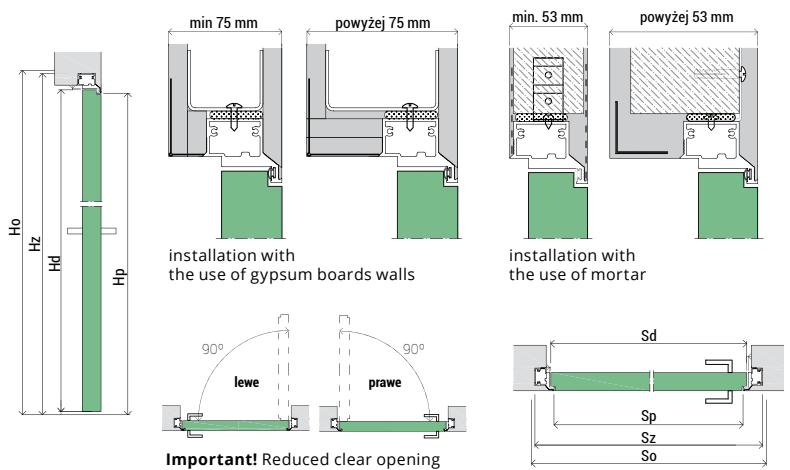

## EXTERNAL DOOR FRAME

Door leaf height Hd	Installation opening height Ho	Door leaf external height Hz	Clear opening height Hp	Amount of hinges
2022	2071	2064	2022	2
2122	2171	2164	2122	2
2222	2271	2264	2222	3
2322	2371	2364	2322	3
Door leaf height Sd	Installation opening height So	Door leaf external height Sz	Width in the door frame clear opening Sp	
618	698	688	603	
718	798	788	703	
818	898	888	803	
918	998	988	903	
1018	1098	1088	1003	

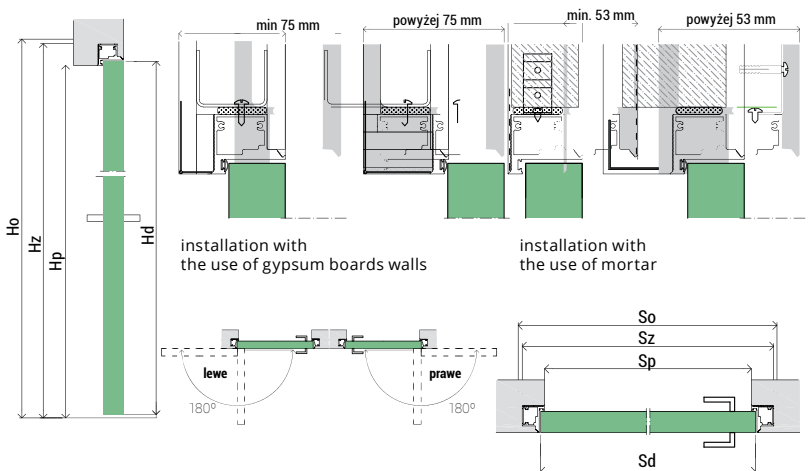

Compact system doors are available in all decors from the following groups: Primo, 3D Look, Iridium, CPL, HPL, Lacqueredowane (more on page 150-151)  
HPL decors only standard offer.

comfort and freedom

FOR EVERY ROOM



# SLIDING DOORS

A way to create an original entrance to the room. They ensure comfortable use and freedom of movement. They are fantastic in small spaces, where using traditional doors requires sort of gymnastics. They also do a great job on a larger surface, catching the eye and giving the interior a modern, dynamic character. They are available in single and double leaf versions. They also differ depending on the mounting method - they can be retracted into the wall or intended for on-wall mounting. Leaves can be chosen from many models with different aesthetics, which is why everyone will find an option ideally suited to their interior.



## DO YOU WANT TO SAVE A PLACE IN THE FLAT?

Sliding doors will help you with that. Thanks to the convenient way of opening and closing, they do not use additional space. Especially recommended for interiors where every centimetre is important.

**UNOBVIOUS DECORATION.**  
The door can play the first violin in interior design. Especially double-leaf models that look very impressive. In spacious rooms they will hit the bullseye.





# DOUBLE LEAF SLIDING SYSTEM

## SINGLE LEAF ON-WALL SLIDING SYSTEM

Single leaf on-wall sliding system consists of a masking element (including a doorstop), sliding system installed in the regulated door frame tunnel or directly on the wall.

Single leaf sliding system is offered in the following dimensions: 60', 70', 80', 90', 100'.

## DOUBLE LEAF SLIDING SYSTEM

Double leaf on-wall sliding system is opened synchronously, i.e. by sliding one leaf, both door leaves open at the same time. Synchronous system requires ordering from us two door leaves of the same width. This system is also installed in the regulated door frame tunnel or directly on the wall.

Double leaf sliding system is offered in the following dimensions: 120', 140', 160', 180', 200' (for doors opening synchronously).

Door leaves for the sliding system are executed in non-rebated version in the external dimensions of the rebated door. e.g.: 844 x 2035 mm (80').

## THE FULL SLIDING SYSTEM CONSISTS OF:

Single door leaf system:

sliding mechanism + masking element (with a doorstop) + 1x door leaf

Double door leaf system:

synchronous sliding element + masking element + 2x door leaf

### Availability:

Sliding system is available in all decors and collections apart from the following collections: Classic, Andromeda, Salvano, Ksantos New.

## Vertical cross-section of the sliding system

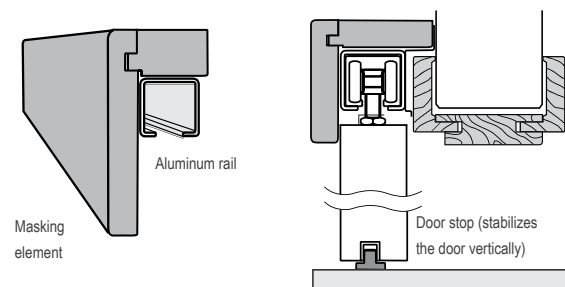





## SINGLE LEAF ON-WALL SLIDING SYSTEM

Door pulls installed in sliding doors for additional payment.  
A colour of a door pull adjusted to a chosen door decor.

### PVC PULLS AND HAND RAILS

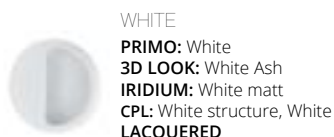
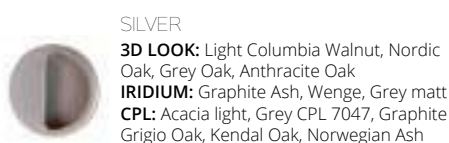
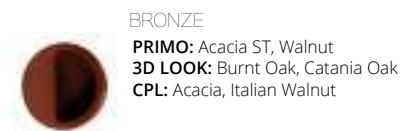
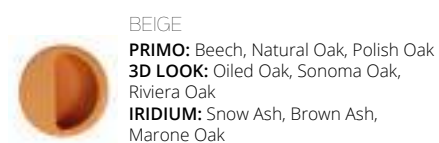

### STEEL DOOR PULLS



Hook lock for regular key



Door closer



Classen sliding doors are available in all decors from the following groups (detailed information - page 150-151) and optionally in RAL colours.



## DIVA

Diva system, thanks to wide, aluminium rail, partially integrated with the door leaf creates aesthetic and modern combination of doors and the sliding system.

The system consists of a mechanism and a door leaf, and it is designed to be installed directly on the wall (lack of possibility of installation with a tunnel).

**Door leaf:** sliding, single leaf, HARD construction, equipped with steel INOX handgrip as a standard. Dedicated exclusively to Diva system.

Door leaf dimensions - 744, 844, 944 x 2135 mm.

**Mechanism:** a full set consists of a 2m aluminium rail, fittings and installation instruction.

Two types of the mechanism are available - standard one and the one with self-closing system. After installation of the system, the gap between the door leaf and the wall is 12 mm.

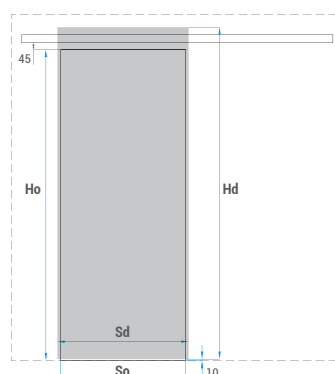

**Door leaf with a rail - connection method**

**Diva system dimensions table:**

	Door leaf height Hd	Wall opening height Ho	Door leaf width Sd	Wall opening width So
70'	2135	2000	744	700
80'			844	800
90'			944	900





**Iridium**



Graphite Ash    Snow Ash    Brown Ash

**CPL**



Italian Walnut    Acacia    Acacia light    Norwegian Ash    Grigio Oak    Kendal Oak    White RAL 9003

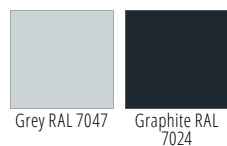

Grey RAL 7047    Graphite RAL 7024

**Lacquered**



White UV    White UV Pure



## DESIGN WALL SLIDING SYSTEM

**Sliding doors means a freedom of moves and the ease of movement. Attractive decors, shiny stainless steel and the highest comfort are combined in one impressive door, allowing smooth opening and closing the room.**

### Design wall sliding system

The system is made entirely of stainless steel, designed for mounting directly on the wall, available only in single leaf version.

Door leaves for the Design sliding system are manufactured in non-rebated version (dimensions as for rebated doors). Available in the following collections: Natura HR, Asteria, Discovery, Tetyda, Demeter and in frame collections.

### Packing

It includes the full sliding system with a rail - length 2100 mm, on which door leaves - width 70', 80', 90' can be installed.

Door pulls installed in sliding doors for additional payment. A colour of a door pull adjusted to a chosen door decor - page 113.



Steel door pulls  
silver (INOX)

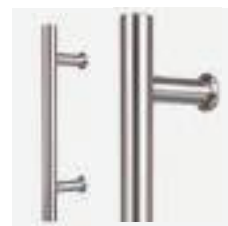

Stainless steel railing  
500 mm, double-sided

### Wall sliding system with a door stop



Table for openings in the wall:

	width	height
70'	702	2010
80'	802	2010
90'	902	2010



It is based on CLASSEN interior single or double leaf non-rebated doors.

The structure of the system made of metal sections consists of a pocket, in which a leaf hides during „opening of the door“.



## IN-WALL SLIDING DOORS SYSTEM

Door pulls installed in sliding doors for additional payment.

A colour of a door pull adjusted to a chosen door decor - page 113.

Table of single pocket dimensions

CODE	L x H	External dimensions			The thickness of the pocket/wall *)	Internal dimensions	Door leaf dimensions	
		C x H1	A	B			LP	HP
G60 plus	610 x 2025	1350 x 2110	670	640	100	53	644	2035
G70 plus	710 x 2025	1550 x 2110	770	740			744	
G80 plus	810 x 2025	1750 x 2110	870	840			844	
G90 plus	910 x 2025	1950 x 2110	970	940			944	
G100 plus	1010 x 2025	2150 x 2110	1070	1040			1044	

Pocket with thickness of 100 mm - possibility of assembly of Classen's full leaves only.

\*) Eclipse door frames for non-typical wall thickness should be ordered in line with the order form.

Frame colours: Classen Primo, Classen 3D Look, Classen Iridium, Classen CPL.

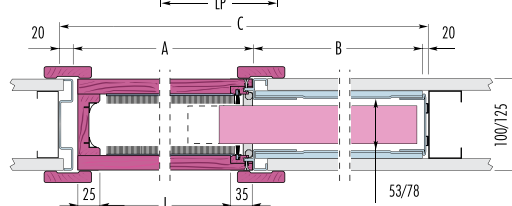
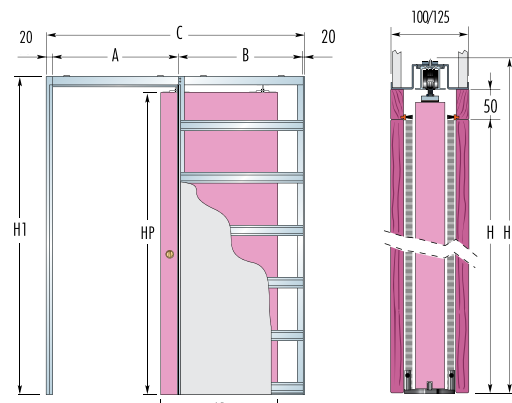

Table of double pocket dimensions

CODE	L x H	External dimensions			The thickness of the pocket/wall *)	Internal dimensions	Door leaf dimensions	
		C x H1	A	B			LP	HP
GG60 plus	1210 x 2025	2600 x 2110	1280	640	100	54	644	2035
GG70 plus	1410 x 2025	3000 x 2110	1480	740			744	
GG80 plus	1610 x 2025	3400 x 2110	1680	840			844	
GG90 plus	1810 x 2025	3800 x 2110	1880	940			944	
GG100 plus	2010 x 2025	4200 x 2110	2080	1040			1044	

Pocket with thickness of 100 mm - possibility of assembly of Classen's full leaves only.

\*) Eclipse door frames for non-typical wall thickness should be ordered in line with the order form.

Frame colours: Classen Primo, Classen 3D Look, Classen Iridium, Classen CPL.

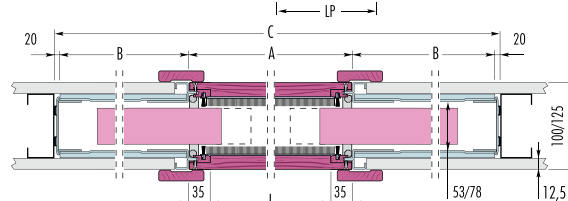
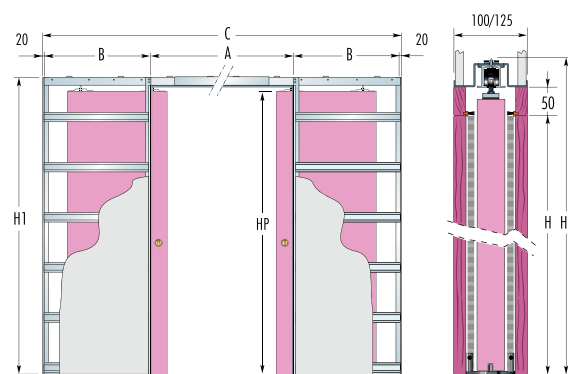

Application	For interior single or double leaf non-rebated doors
Technical approval no.	AT-15-7002/2015
Set's composition	100 or 125 pocket with door ferrules, door frame elements in Classen decor Classen sliding door leaf



## EXTENSIONS

### EXECUTION STANDARD

- veneered passive door, width 40' and 50'
- construction: MDF peripheral frame plus stabilizing honeycomb insert
- Hard Edge K or Hard Edge R door leaf profile
- finishing: Classen Primo, Classen Iridium, Classen 3D Look, Classen CPL
- two or three silver screwed pintle hinges
- strike plate and shoot bolt

\* available only with selected models of door frames – Standard 2-pack, Fixed, Adjustable

### OPTIONS FOR ADDITIONAL PAYMENT

- reinforced with perforated chipboard
- third hinge





**ADJUSTABLE** (page 120)



**ADJUSTABLE 80** (page 120)



**ADJUSTABLE NON-REBATED** (page 121)



**ADJUSTABLE NON-REBATED 80** (page 121)



**NEW ARCUS** (page 122)



**ARCUS** (page 123) view from the inside of the leaf. Outer side like in the Standard 2 pack door frame.



**STANDAR 2 PACK** (page 124)

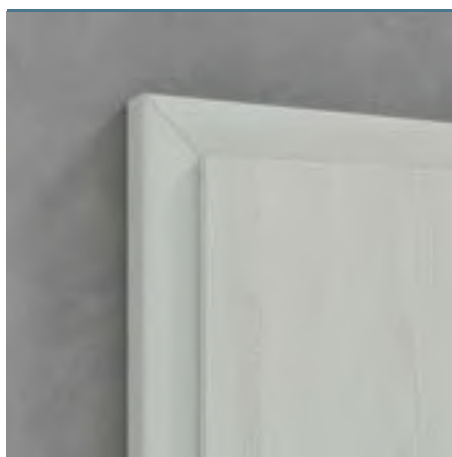

**CMOK** (page 125)



**HYBRID** (page 126) from the outside, a wood-derivative door frame in a decor colour.

# WOOD-BASED DOOR FRAMES

## EXECUTION STANDARD

**Adjustable door frames** are made of chipboard and MDF covered with Classen Primo, Classen 3D look, Classen Iridium veneer and Classen CPL laminate in decors corresponding to door leaf decors. Available also in Tunel version.

**Packing:** Complete door frame consists of upper beam and base elements and it constitutes one package. The set includes ferrules, gaskets and assembly set. For door leaves of dimension 100' or reinforced leaves, it is required to use door frame with three hinges.

## COLOURS

**Classen Primo:** Acacia ST, White, Natural Oak pion, Beech, Polish Oak, Walnut.

**Classen 3D Look<sup>®</sup>:** Burnt Oak, Oiled Oak, White Ash, Sonoma Oak, Light Columbia Walnut, Riviera Oak, Grey Oak, Nordic Oak, Anthracite Oak, Catania Oak.

**Classen Iridium:** White matt<sup>®</sup>, Snow Ash<sup>®</sup>, Brown Ash, Graphite Ash<sup>®</sup>, wenge, Marone Oak, Grey matt.

**Classen CPL:** Acacia<sup>®</sup>, Acacia light<sup>®</sup>, White<sup>®</sup>, Grey 7047, Graphite 7024, Italian Walnut<sup>®</sup>, Norwegian Ash<sup>®</sup>, Kendal Oak<sup>®</sup>, Grigio Oak<sup>®</sup>, White structure.

**Lacquered<sup>®</sup>:** Lacquered White UV or PU.

**Adjustable door frame 80** available in decors marked <sup>®</sup>. Not available on models Natura HK CPL - PN22 i PN23.

**RAL**, additional payment table on **page 142**.  
Black matt - additional payment **25%**.



## ADJUSTABLE / ADJUSTABLE 80

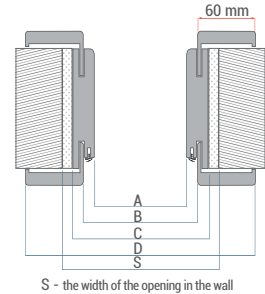
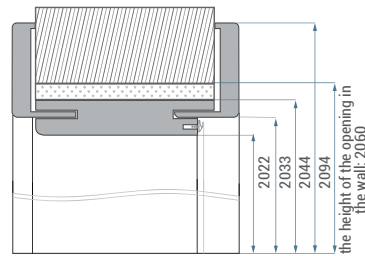
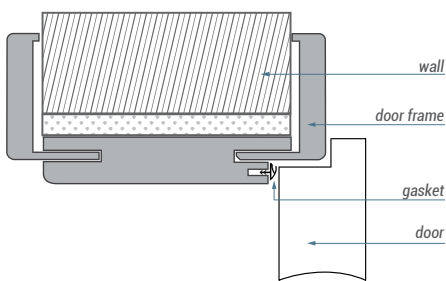

▲ Adjustable door frame  
▼ Adjustable door frame 80

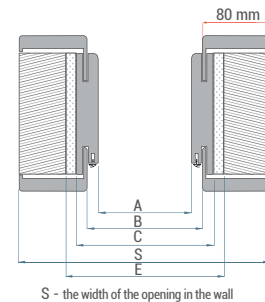
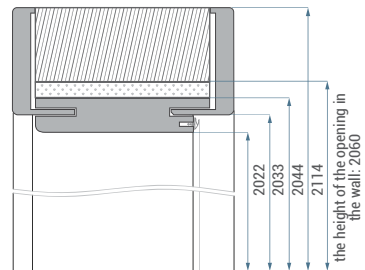
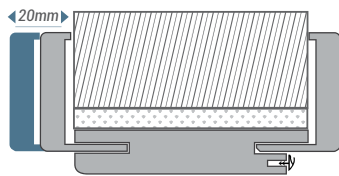

## CROWN MOULDING

Designed for assembly with Adjustable door frame (single leaf).

more on **page 143**



### Dimensions of the adjustable door frame [mm]:

	A	B	C	D	E	S	
SINGLE LEAF	60	603	625	648	748	788	675
	70	703	726	748	848	888	775
	80	803	826	848	948	988	875
	90	903	926	948	1048	1088	975
	100	1003	1026	1048	1148	1188	1075
	110	1103	1126	1148	1248	1288	1175
DOUBLE LEAF	120	1203	1226	1248	1348	1388	1275
	100	1038	1061	1083	1183	1223	1110
	110	1138	1161	1183	1283	1323	1210
	120	1238	1261	1283	1383	1423	1310
	130	1338	1361	1383	1483	1523	1410
	140	1438	1461	1483	1583	1623	1510
	150	1538	1561	1583	1683	1723	1610
	160	1638	1661	1683	1783	1823	1710
	170	1738	1761	1783	1883	1923	1810
	180	1838	1861	1883	1983	2023	1910
190	1938	1961	1983	2083	2123	2010	
200	2038	2061	2083	2183	2223	2110	

### OPTIONS FOR ADDITIONAL PAYMENT:

- third hinge
- door frame 100': + 20%
- door frame 110': + 30%
- door frame 120': + 35%
- frame height PN 22 + 35%
- frame height PN 23 + 40%
- door clamp 80
- door frame for double leaf door: + 50%



## EXECUTION STANDARD

**Adjustable non-rebated door frames** are made of chipboard and MDF board, covered with Classen Adjustable non-rebated door frames are made of chipboard and MDF board, covered with Classen decors or lacquered corresponding to door leaves decors. This door frame, in decors corresponding to door leaves decors. This door frame is dedicated to non-rebated „B” door leaves.

### Packing:

Complete non-rebated door frame consists of upper beam and base elements and it constitutes one package. The set includes two non-rebated hidden hinges, gaskets and an assembly set.

## COLOURS

**Classen Primo:** White.

**Classen Iridium:** Snow Ash, Brown Ash, Graphite Ash<sup>\*)</sup>, Wenge.

**Classen CPL:** Acacia<sup>\*)</sup>, Acacia light<sup>\*)</sup>, White<sup>\*)</sup>, Grey 7047, Italian Walnut<sup>\*)</sup>, Graphite 7024, Norwegian Ash<sup>\*)</sup>, Kendal Oak<sup>\*)</sup>, Grigio Oak<sup>\*)</sup>, White structure.

**Lacquered<sup>\*)</sup>:** Lacquered White UV or PU.

**Non-rebated adjustable door frames 80** available in decors marked <sup>\*)</sup>  
Not available on models Natura HB CPL PN22 i PN23.

**RAL:** additional payment table on **page 142**.  
Black matt dopłata + 25%.



## ADJUSTABLE NON-REBATED / ADJUSTABLE NON-REBATED 80

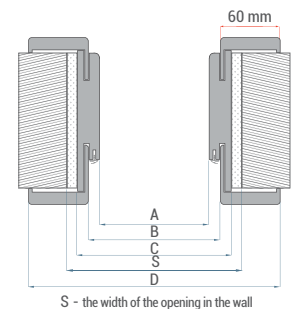
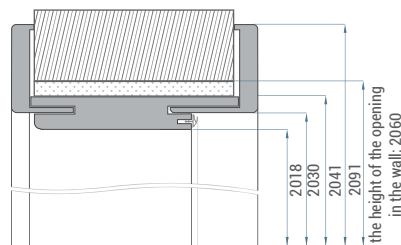
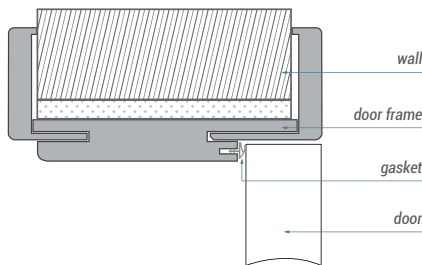

▲ Non-rebated adjustable door frames

▼ Non-rebated adjustable door frames 80

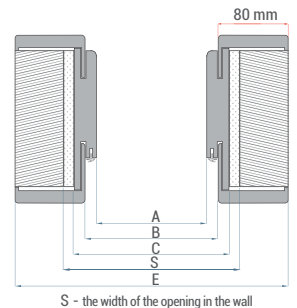
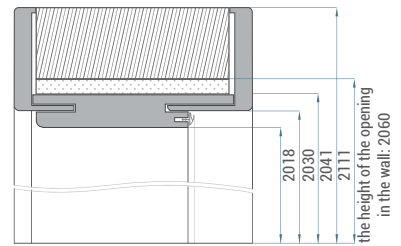
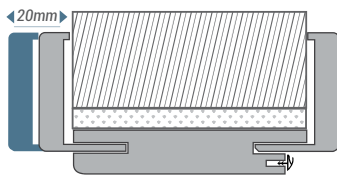

## CROWN MOULDING

Designed for assembly with Adjustable door frame. (single leaf).

more on **page 143**



Dimensions of the adjustable non-rebated door frame [mm]:

	A	B	C	D	E	S
60	601	624	646	746	786	690
70	701	724	746	846	886	790
80	801	824	846	946	986	890
90	901	924	946	1046	1086	990
100	1001	1024	1046	1146	1186	1090



Hinge



Strike plate

### OPTIONS FOR ADDITIONAL PAYMENT:

- door frame 100': + 20%
- door clamp 80

# WOOD-BASED DOOR FRAMES

## EXECUTION STANDARD

## COLOURS



### NEW ARCUS

**NEW ARCUS door frames** are made of MDF covered with Classen Primo, Classen 3D look, Classen Iridium veneer and Classen CPL laminate in decors corresponding to door leaf decors. Besides modern design, the advantage of this door frame is its universal application - for the purpose of adjustment to different wall thickness, this door frame is available in two adjustment ranges: 115 - 200 mm and 200 - 320 mm. Available also in Tunel version.

#### Packing:

Complete door frame consists of upper beam and base element (two separate packages), which is equipped with two silver pintle hinges (the third hinge - for extra charge).

For door leaves of dimension 100' or reinforced leaves, it is required to use door frame with three hinges.

**Classen Primo:** Acacia ST, Walnut.

**Classen 3D Look:** Burnt Oak, White Ash, Light Columbia Walnut, Grey Oak.

**Classen Iridium:** Brown Ash, Graphite Ash, Wenge, Marone Oak.

**Classen CPL:** Acacia, Acacia light, Italian Walnut, Norwegian Ash, Kendal Oak, Grigio Oak.

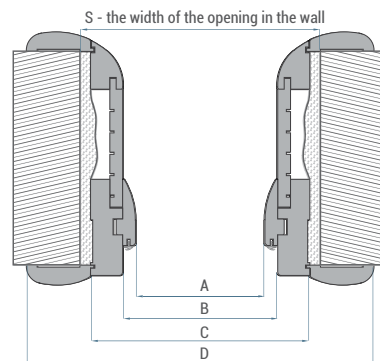
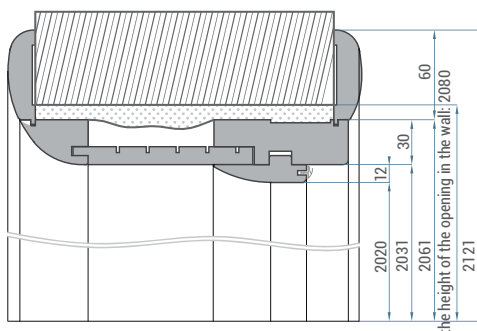
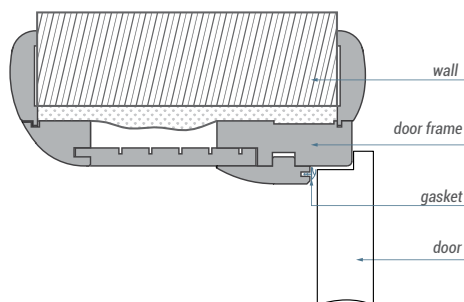

Dimensions of NEW ARCUS door frame [mm]:

	A	B	C	D	S	
SINGLE LEAF	60	602	626	686	806	710
	70	702	726	786	906	810
	80	802	826	886	1006	910
	90	902	926	986	1106	1010
	100	1002	1026	1086	1206	1110
DOUBLE LEAF	100	1037	1061	1121	1241	1145
	110	1137	1161	1221	1341	1245
	120	1237	1261	1321	1441	1345
	130	1337	1361	1421	1541	1445
	140	1437	1461	1521	1641	1545
	150	1537	1561	1621	1741	1645
	160	1637	1661	1721	1841	1745
	170	1737	1761	1821	1941	1845
	180	1837	1861	1921	2041	1945
	190	1937	1961	2021	2141	2045
200	2037	2061	2121	2241	2145	

#### OPTIONS FOR ADDITIONAL PAYMENT:

- regulatory insert 200-320 mm
- third hinge
- door frame 100': +20%
- door frame for double leaf door: +50%

## EXECUTION STANDARD

## COLOURS



## ARCUS

**Arcus door frames** are made of MDF covered with Classen Primo, Classen 3D look, Classen Iridium veneer and Classen CPL laminate in decors corresponding to door leaf decors. Base elements have been one sided integrated with finishing mouldings. Available also in Tunel version.

### Packing:

Complete door frame consists of upper beam and base element (two separate packages), which is equipped with two silver pintle hinges (the third hinge - for extra charge).

For door leaves of dimension 100' or reinforced leaves it is required to use door frame with three hinges.

**Classen Primo:** Acacia ST, White, Natural Oak pion, Polish Oak, Walnut.

**Classen 3D Look:** Burnt Oak, White Ash, Light Columbia Walnut, Grey Oak.

**Classen Iridium:** Brown Ash, Graphite Ash, Wenge.

**Classen CPL:** Acacia, Acacia light, Italian Walnut, Norwegian Ash.

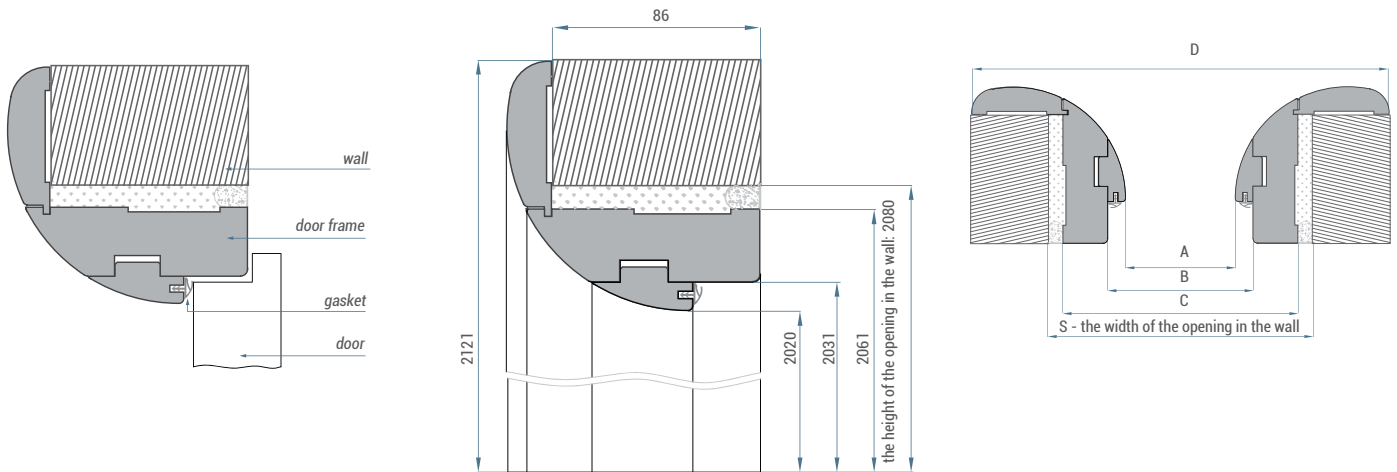

Dimensions of Arcus door frame [mm]:

	A	B	C	D	S	
SINGLE LEAF	60	602	626	686	806	710
	70	702	726	786	906	810
	80	802	826	886	1006	910
	90	902	926	986	1106	1010
	100	1002	1026	1086	1206	1110
DOUBLE LEAF	100	1037	1061	1121	1241	1145
	110	1137	1161	1221	1341	1245
	120	1237	1261	1321	1441	1345
	130	1337	1361	1421	1541	1445
	140	1437	1461	1521	1641	1545
	150	1537	1561	1621	1741	1645
	160	1637	1661	1721	1841	1745
	170	1737	1761	1821	1941	1845
	180	1837	1861	1921	2041	1945
	190	1937	1961	2021	2141	2045
200	2037	2061	2121	2241	2145	

### OPTIONS FOR ADDITIONAL PAYMENT:

- third hinge
- door frame 100': +20%
- door frame for double leaf door: + 50%

# WOOD-BASED DOOR FRAMES

## EXECUTION STANDARD

## COLOURS



### STANDARD 2-PACK

**Standard 2-pack door frames** are made of MDF covered with Classen Primo, Classen 3D look, Classen Iridium veneer and Classen CPL laminate in decors corresponding to door leaf decors. Available also in Tunel version.

**Packing:**

Complete door frame consists of upper beam and base element (two separate packages), which is equipped with two silver pintle hinges (the third hinge - for extra charge). For door leaves of dimension 100' or reinforced leaves, it is required to use door frame with three hinges.

**Classen Primo:** Acacia ST, White, Natural Oak pion, Beech, Polish Oak, Walnut.

**Classen 3D Look:** Oiled Oak, Burnt Oak, White Ash, Sonoma Oak, Light Columbia Walnut, Riviera Oak, Grey Oak, Nordic Oak, Anthracite Oak, Catania Oak

**Classen Iridium:** Snow Ash, Brown Ash, Graphite Ash, wenge, White matt, Marone Oak, Grey matt.

**Classen CPL:** Acacia, Acacia light, Italian Walnut, White, Grey 7047, Graphite 7024, Norwegian Ash, Kendal Oak, Grigio Oak.

**Lacquered:** Lacquered White UV or PU.

**RAL:** additional payment table on **page 142**. Black matt - additional payment + 25%.

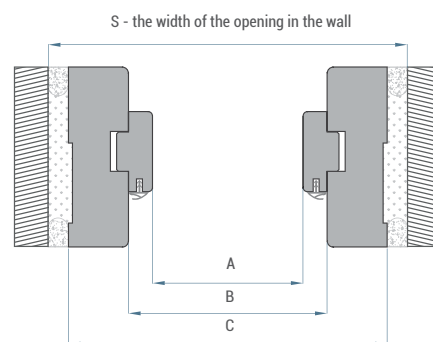
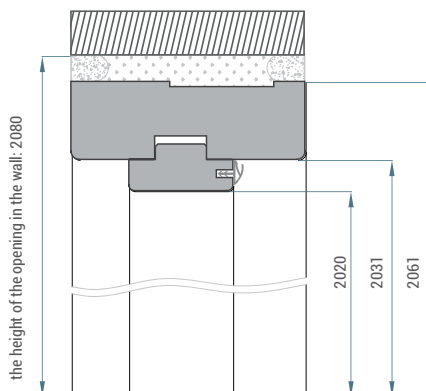
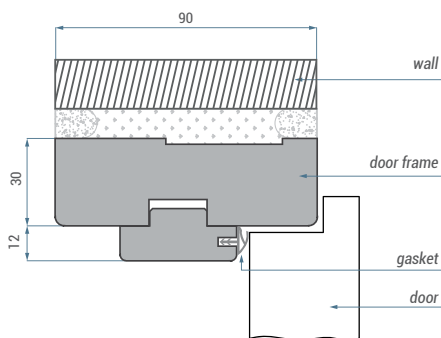

Dimensions of Std 2-pack door frame [mm]:

	A	B	C	S	
SINGLE LEAF	60	602	626	686	710
	70	702	726	786	810
	80	802	826	886	910
	90	902	926	986	1010
	100	1002	1026	1086	1110
	110	1102	1126	1186	1210
	120	1202	1226	1286	1310
DOUBLE LEAF	100	1037	1061	1121	1145
	110	1137	1161	1221	1245
	120	1237	1261	1321	1345
	130	1337	1361	1421	1445
	140	1437	1461	1521	1545
	150	1537	1561	1621	1645
	160	1637	1661	1721	1745
	170	1737	1761	1821	1845
	180	1837	1861	1921	1945
	190	1937	1961	2021	2045
200	2037	2061	2121	2145	

OPTIONS FOR ADDITIONAL PAYMENT:

- third hinge
- door frame 100': +20%
- door frame 110': +30%
- door frame 120': +35%
- door frame for double leaf door: + 50%

## EXECUTION STANDARD

## COLOURS



## CMOK

Adjustable door frame, designed to be installed on steel door frame, without the need to dismantle it beforehand. It allows the exchange of door leaves while maintaining their current dimensions. A distinctive feature of this door frame is a quick and easy installation possible owing to permanent fixture of two base elements. The door frame is fully made of wood-based material - MDF covered with Classen Primo, 3D and Iridium and CPL laminate.

### Packing:

A complete door frame is available in two adjustment ranges: 70-110 mm and 110-150 mm. Both ranges are available in a single package, which also contains gasket and assembly bag.

For door leaves of dimension 100' and reinforced door leaves, it is required to use a door frame with three hinges.

**Classen Primo:** Acacia ST, Natural Oak, Beech, Polish Oak, Walnut, White.

**Classen 3D Look:** Sonoma Oak, White Ash, Burnt Oak, Oiled Oak, Light Columbia Walnut, Riviera Oak, Grey Oak, Nordic Oak, Anthracite Oak, Catania Oak,

**Classen Iridium:** Snow Ash, Brown Ash, Graphite Ash, Wenge, Marone Oak.

**Classen CPL:** Italian Walnut, Acacia, Acacia light, Norwegian Ash, Kendal Oak, Grigio Oak.

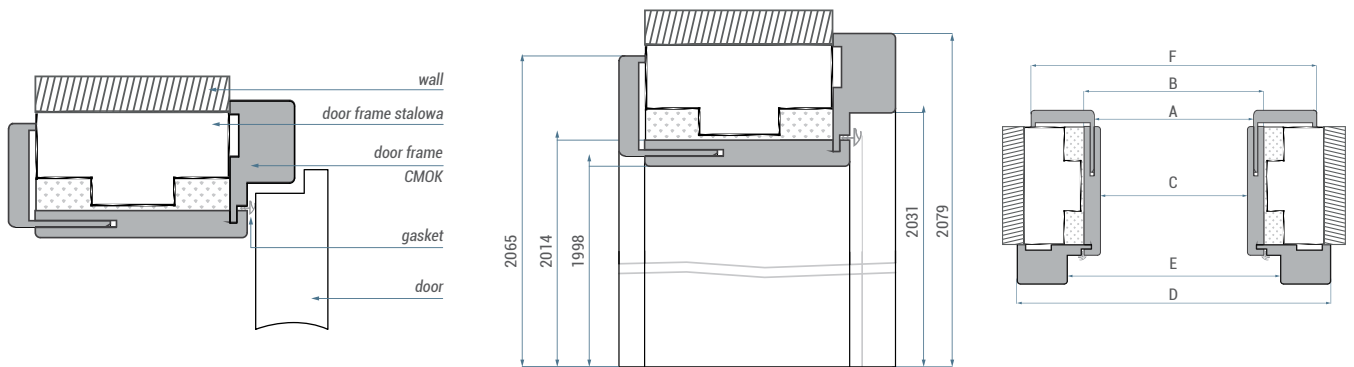

### Installation - remarks:

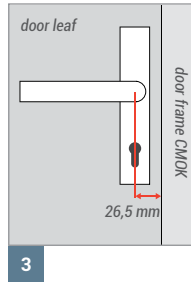

1. Curvature of walls, on which CMOK door frame will be installed - **fig. 1**.
2. Place of floors connection and moving of the door leaf after installing CMOK door frame - **fig. 2**.
3. Handle and rozetta dimensions. The hand of a door handle cannot go beyond the spindle - **fig. 3**.

### Dimensions of CMOK door frame [mm]:

	A	B	C	D	E	F
60	574	593	561	723	626	696
70	674	693	661	823	726	796
80	774	793	761	923	826	896
90	874	893	861	1023	926	996
100	974	993	961	1123	1026	1096
110	1074	1093	1061	1223	1126	1196

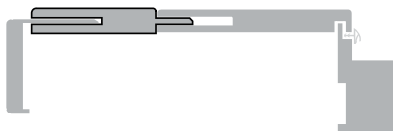

Regulatory insert 75mm increases the adjustment range:  
 - in the door frame 70-110mm to 150-185mm  
 - in the door frame 110-150mm to 185-220mm

### OPTIONS FOR ADDITIONAL PAYMENT:

- third hinge
- door frame 100': +20%
- door frame 110': +30%

# WOOD-BASED AND STEEL DOOR FRAMES

## EXECUTION STANDARD



**Hybryda door frame** is designed for BORD B, W and W3 internal entrance door leaves.

It consists of Hybryda steel door frame and regulatory element. When installed, they create one whole.

Depending on the direction of opening the door, the regulatory element may relate to the colour of the joinery inside the flat or be a decoration of the staircase.

**Packaging:**

Hybryda steel door frame and regulatory element are packed in two separate packages.

## COLOURS

**Regulatory element is available in the following decors:**

**Classen Iridium:** Snow Ash, Brown Ash, Graphite Ash, Wenge.

**Classen CPL:** Acacia, Acacia light, Norwegian Ash, Italian Walnut, White, Grey 7047, Graphite 7024, Grigio Oak, Kendal Oak, White structure.

**Hybryda steel door frame:**

Powder coated door frame.  
Kolory RAL: White (9003), Grey (7047), Graphite (7024).

## HYBRID

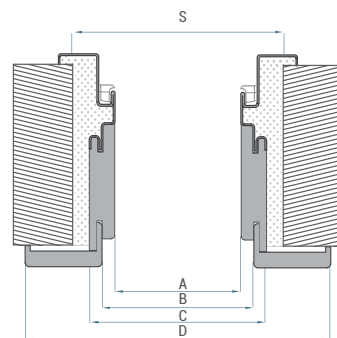
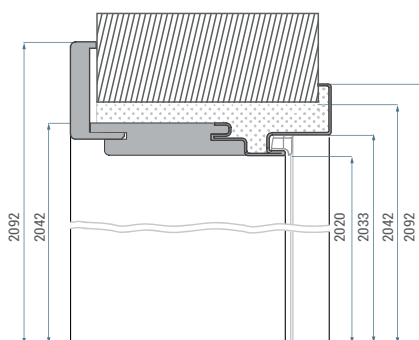
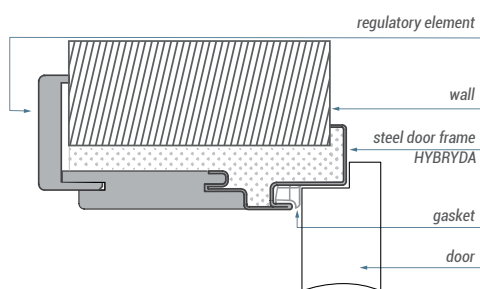

Dimensions of HYBRID steel door frame [mm]:

	A	B	C	D
60	604	626	648	749
70	704	726	748	849
80	804	826	848	949
90	904	926	948	1049
100	1004	1026	1048	1149

REGULATORY ELEMENT

140-180
180-220
220-260
260-300

OPTIONS FOR ADDITIONAL PAYMENT:

- colours RAL 7024, 9003: +5%
- dimension 100': +20%

## EXECUTION STANDARD

## COLOURS



## STEEL ADJUSTABLE

**Adjustable steel door frames** are designed for installation in different types of rooms with completed walls and floor - flats, public utility building, hotels, etc. Durable construction enables application both in masonry walls as well as gypsum boards walls.

### Construction:

- Made of high quality steel plate, thickness 1.5 mm.
- The full door frame consists of one base element, hinges, gasket and full set of cover caps.
- gaskets available in three colours - white, grey, brown.
- two hinges as standard; third hinge as option without additional payment.

### Surface finishing:

- Powder coated door frame. RAL colours: White (9003), Grey (7047), Graphite (7024).
- Other RAL colours as well as other custom features are subject to individual pricing.

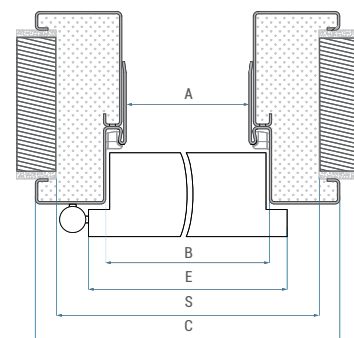
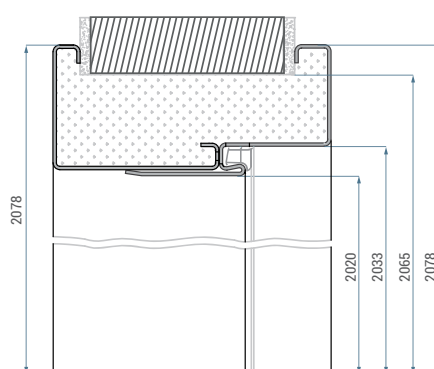
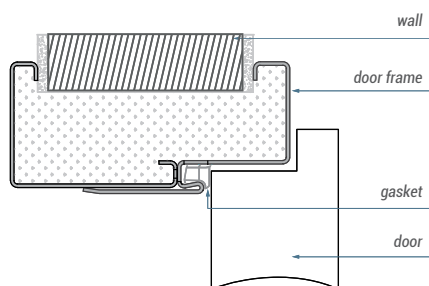

Dimensions of the adjustable steel door frame [mm]:

	A	B	C	E	S	
SINGLE LEAF	60	601	627	717	644	685
	70	701	727	817	744	785
	80	801	827	917	844	885
	90	901	927	1017	944	985
	100	1001	1027	1117	1044	1085
	110	1101	1127	1217	1144	1185
120	1201	1227	1317	1244	1285	
DOUBLE LEAF	100	1035	1061	1151	1079	1120
	110	1135	1161	1251	1179	1220
	120	1235	1261	1351	1279	1320
	130	1335	1361	1451	1379	1420
	140	1435	1461	1551	1479	1520
	150	1535	1561	1651	1579	1620
	160	1635	1661	1751	1679	1720
	170	1735	1761	1851	1779	1820
	180	1835	1861	1951	1879	1920
	190	1935	1961	2051	1979	2020
200	2035	2061	2151	2079	2120	

RANGE ADJUSTMENT

95 - 125
125 - 155
155 - 185
185 - 215
215 - 245
245 - 275
275 - 305
305 - 335
335 - 365

### OPTIONS FOR ADDITIONAL PAYMENT:

- reinforcement for door closer
- dimension 100': +20%
- preparation for electric (door) strike
- execution in galvanized steel: +15%
- transition threshold
- double leaf door frames: +50%
- colours RAL 7024, 9003: +5%

## EXECUTION STANDARD

## COLOURS



### Construction:

- made of high quality steel plate, thickness 1.5 mm.
- the full door frame consists of one base element, hinges, gasket and full set of cover caps.
- gaskets available in three colours - white, grey, brown.
- two hidden hinges 3D as standard
- door frame designed for installation in rooms with completed walls and floor.
- available only in single leaf version.

### Surface finishing:

- powder-coated door frame. RAL COLOURS: white (9003), grey (7047), graphite (7024).
- other RAL colours as well as other custom features are subject to individual pricing.

## ADJUSTABLE NON-REBATED STEEL DOOR FRAME

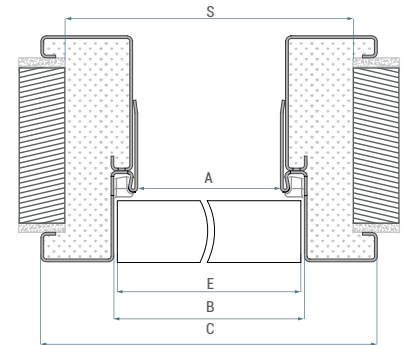
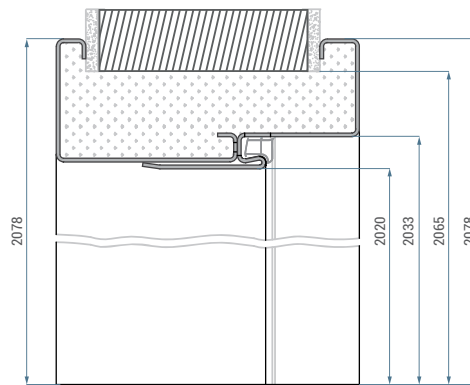
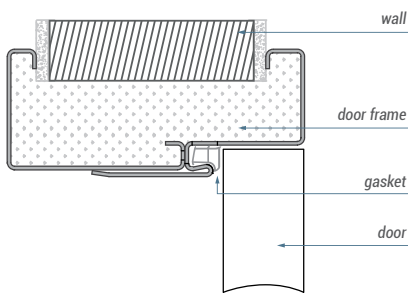

Dimensions of the adjustable non-rebated steel door frame [mm]:

	A	B	C	E	S
60	601	627	717	644	695
70	701	727	817	744	795
80	801	827	917	844	895
90	901	927	1017	944	995
100	1001	1027	1117	1044	1095
110	1101	1127	1217	1144	1195
120	1201	1227	1317	1244	1295

RANGE ADJUSTMENT

110 - 140
140 - 170
170 - 200
200 - 230
230 - 260
260 - 290
290 - 320
320 - 350
350 - 380

### OPTIONS FOR ADDITIONAL PAYMENT:

- reinforcement for door closer
- dimension 100': +20%
- preparation for electric (door) strike
- execution in galvanized steel: +15%
- transition threshold
- colours RAL 7024, 9003: +5%



## EXECUTION STANDARD



### Construction:

- made of high quality steel plate, thickness 1.2 mm.
- the full door frame consists of one base element, hinges, gasket and full set of cover caps.
- gaskets available in three colours - white, grey, brown
- two hidden hinges 3D as standard (non-rebated version),
- two hinges as standard; third hinge as option without additional payment (rebated version)
- door frame designed for installation in rooms with completed walls and floor
- non-rebated door frame available only in single leaf version

## COLOURS

### Surface finishing:

- Powder coated door frame. RAL colours: White (9003), Grey (7047), Graphite (7024).
- Other RAL colours as well as other custom features are subject to individual pricing.

## FIXED STEEL NON-REBATED

## FIXED STEEL

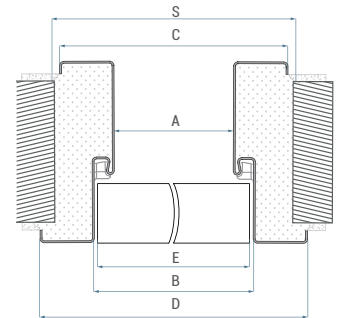
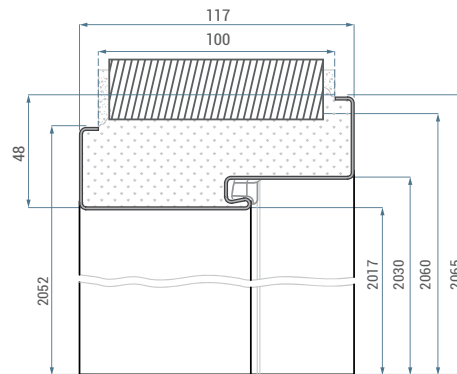
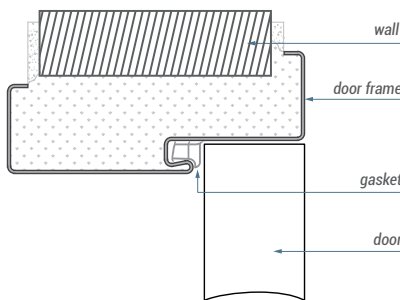

▲ FIXED STEEL NON-REBATED DOOR FRAME

▼ FIXED STEEL DOOR FRAME

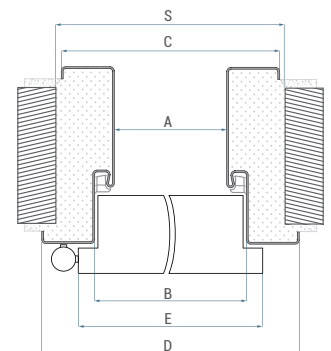
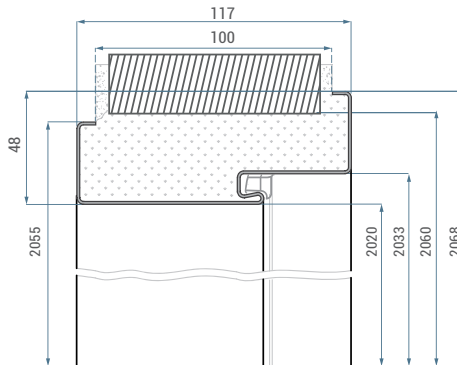
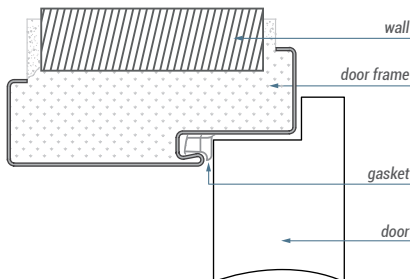

Dimensions of fixed steel and fixed steel non-rebated door frame (single leaf) [mm]:

	A	B	C	D	E	S	
SINGLE LEAF	60	601	627	671	697	644	685
	70	701	727	771	797	744	785
	80	801	827	871	897	844	885
	90	901	927	971	997	944	985
	100	1001	1027	1071	1097	1044	1085
	110	1101	1127	1171	1197	1144	1185
	120	1201	1227	1271	1297	1244	1285
DOUBLE LEAF	120	1235	1261	1305	1331	1279	1315
	130	1335	1361	1405	1431	1379	1415
	140	1435	1461	1505	1531	1479	1515
	150	1535	1561	1605	1631	1579	1615
	160	1635	1661	1705	1731	1679	1715
	170	1735	1761	1805	1831	1779	1815
	180	1835	1861	1905	1931	1879	1915
	190	1935	1961	2005	2031	1979	2015
	200	2035	2061	2105	2131	2079	2115

### OPTIONS FOR ADDITIONAL PAYMENT:

- reinforcement for door closer
- dimension 100': +20%
- preparation for electric (door) strike
- execution in galvanized steel: +15%
- transition threshold
- double leaf door frames: +50%
- colours RAL 7024, 8014, 9003, 1015: +5%

# STEEL DOOR FRAMES

## EXECUTION STANDARD

- steel plate thickness 1.2 mm;
- openings for bolt lock top and bottom (B) or multipoint lock openings (W)
- openings for anti-burglary bolts only in fixed door frames for leaves version W1 and W2
- reinforcement for door closer
- single leaf 80'-100'

## COLOURS

### Surface finishing:

- Powder coated door frame. RAL colours: White (9016), White (9003), Grey (7047), Bronze (8017) Graphite (7024).
- Other RAL colours as well as other custom features are subject to individual pricing.



## BORD CORNER STEEL

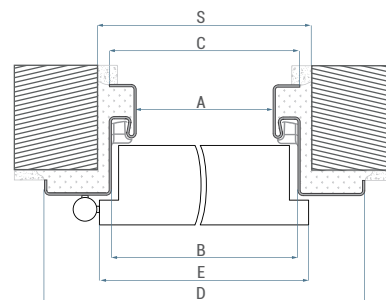
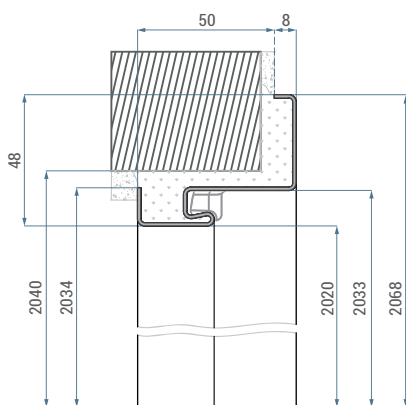
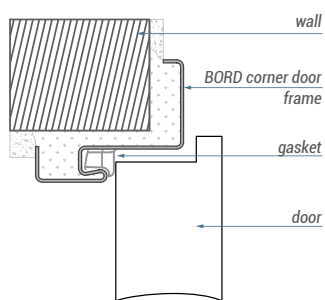

Dimensions of BORD corner door frame [mm]:

	A	B	C	D	E	S
80	801	827	829	897	844	865
90	901	927	929	997	944	965
100	1001	1027	1029	1097	1044	1065

### OPTIONS FOR ADDITIONAL PAYMENT:

- dimension 100': +20%
- transition threshold
- colours RAL 7024, 9003: +5%

## EXECUTION STANDARD



- steel plate thickness 1.2 mm;
- openings for bolt lock top and bottom (B) or multipoint lock openings (W)
- openings for anti-burglary bolts only in fixed door frames for leaves version W1 and W2
- reinforcement for door closer
- single leaf 80'-100'

## COLOURS

### Surface finishing:

- Powder coated door frame. RAL colours: White (9016), White (9003), Grey (7047), Bronze (8017) Graphite (7024).
- Other RAL colours as well as other custom features are subject to individual pricing.

## BORD STEEL FIXED

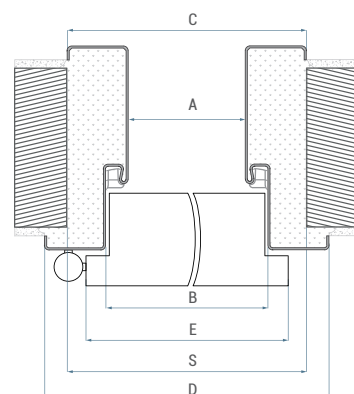
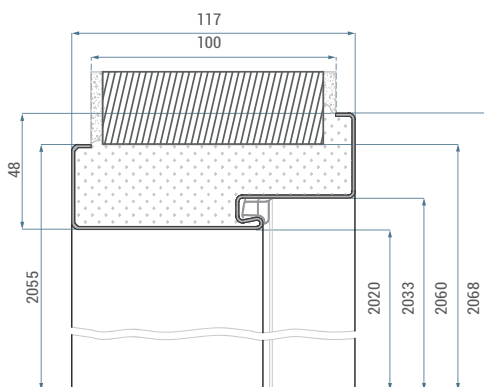
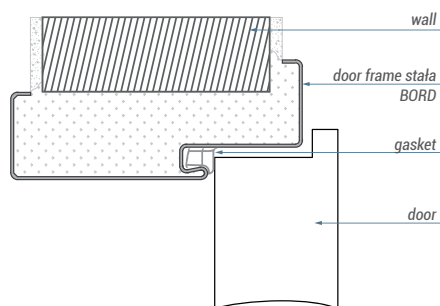

Dimensions of BORD fixed door frame [mm]:

	A	B	C	D	E	S
80	801	827	871	897	744	875
90	901	927	971	997	844	975
100	1001	1027	1071	1097	944	1075

### OPTIONS FOR ADDITIONAL PAYMENT:

- dimension 100': +20%
- transition threshold
- colours RAL 7024, 9003: +5%

# DOOR FRAMES DEDICATED TO BORD COLLECTION

## EXECUTION STANDARD

**This door frame** is designed for internal entrance door leaves. It is made of MDF board, veneered with Classen decors.

### Construction, finishing:

- surface finishing: Classen Primo, Classen Iridium, Classen 3D Look, Classen CPL
- bolt lock striking plate top and bottom (B) or multipoint lock striking plate (W)
- version W2 includes sleeves for anti-burglary bolts
- single leaf 80'-100'

## COLOURS

**Classen Primo:** Acacia ST, White, Natural Oak pion, Beech, Polish Oak, Walnut.

**Classen 3D Look:** Oiled Oak, Burnt Oak, White Ash, Light Columbia Walnut, Sonoma Oak, Riviera Oak, Grey Oak, Nordic Oak, Anthracite Oak.

**Classen Iridium:** Snow Ash, Brown Ash, Graphite Ash, Wenge, White structure 9003.

**Classen CPL:** Italian Walnut, Acacia, Acacia light, White CPL, Grey CPL (7047), Graphite (RAL 7024), Norwegian Ash, Kendal Oak, Grigio Oak.



## BORD MDF

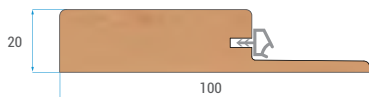
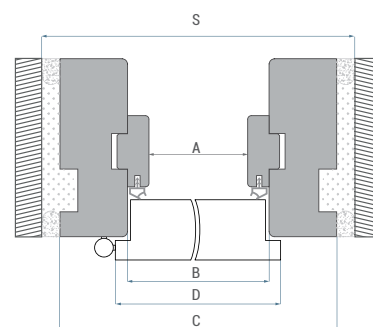
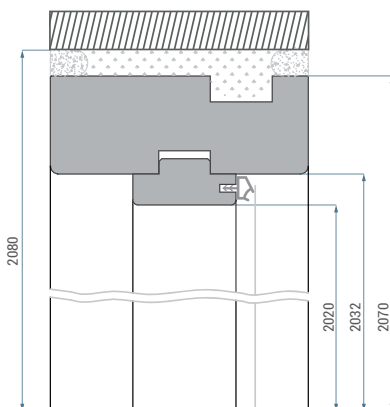
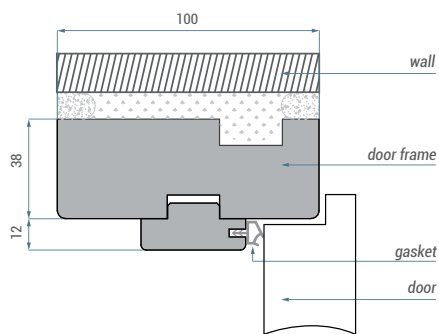

Dimensions of BORD MDF door frame [mm]:

	A	B	C	D	S
80	802	826	902	844	925
90	902	926	1002	944	1025
100	1002	1026	1102	1044	1125

### Fixed, wooden threshold

With a gasket, width 100' - for adjustment.  
Hard wood, protected with colourless lacquer.

- OPTIONS FOR ADDITIONAL PAYMENT:
- dimension 100': +20%
  - fixed, wooden threshold (16 x 79mm)
  - fixed, wooden threshold (20 x 100mm)



## EXECUTION STANDARD

- steel plate thickness 1.5 mm;
- complete door frame includes gasket, three hinges and full set of cover caps.
- gaskets available in three colours - white, grey, brown.
- openings for multipoint lock (W)
- openings for anti-burglary bolts
- reinforcement for door closer
- single leaf 80'-100'
- single leaf 80'-100'

## COLOURS

### Surface finishing:

- Powder coated door frame. RAL colours: White (9016), White (9003), Grey (7047), Bronze (8017) Graphite (7024).
- Other RAL colours as well as other custom features are subject to individual pricing.

## BORD STEEL FIXED W3

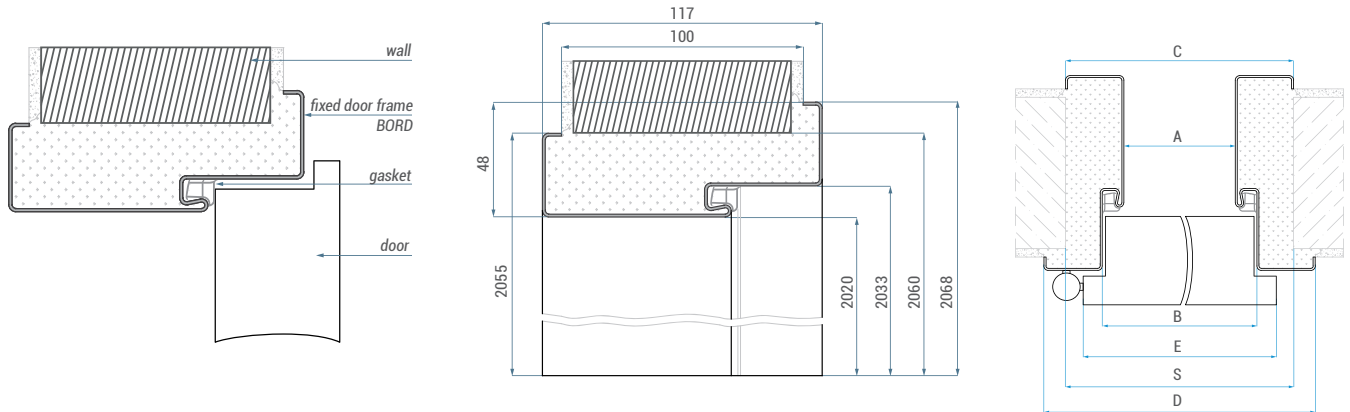

Dimensions of W3 BORD fixed steel door frame [mm]:

	A	B	C	D	E	S
80	801	827	871	897	844	885
90	901	927	971	997	944	985
100	1001	1027	1071	1097	1044	1085

# DOOR FRAMES DEDICATED TO GUARD COLLECTION

## EXECUTION STANDARD

### Construction:

- made of high quality steel plate, thickness: 1.5 mm.
- complete door frame includes gasket, hinges and full set of cover caps.
- gaskets available in three colours: white, grey, brown.
- 3 silver three-way hinges constitute a complete set (door + door frame).

## COLOURS

### Surface finishing:

- Powder coated door frame. RAL colours: White (9003), Grey (7047), Bronze (8017) Graphite (7024).

- Other RAL colours as well as other custom features are subject to individual pricing.

- additional payment: colours RAL 7024, 9003: +5%.



**GUARD STEEL  
FIXED**



**GUARD STEEL  
ADJUSTABLE**

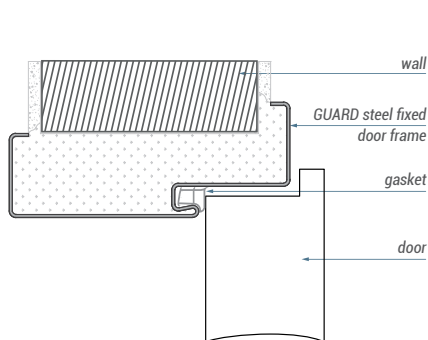

▲ GUARD STEEL FIXED

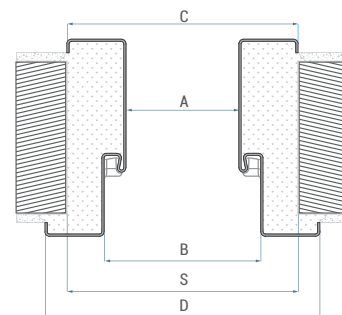
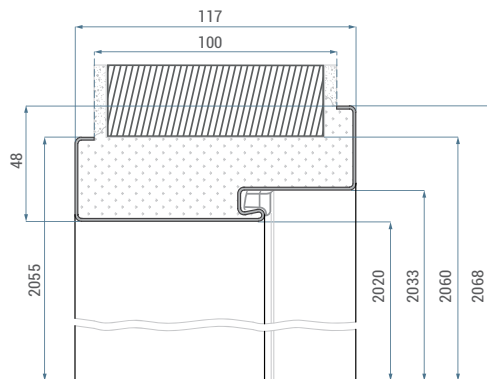

▼ GUARD STEEL ADJUSTABLE

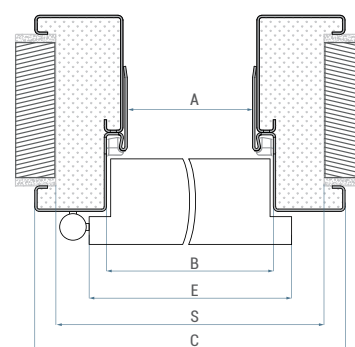
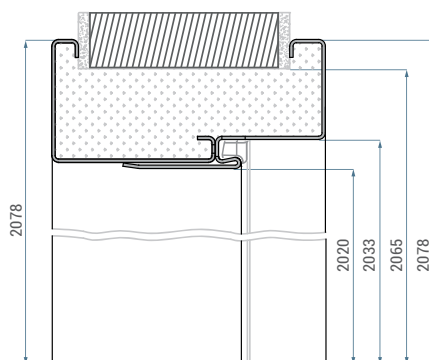
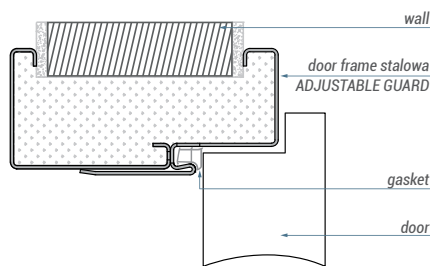

Dimensions of GUARD fixed door frame [mm]:

	A	B	C	D	S
70	701	727	771	797	785
80	801	827	871	897	885
90	901	927	971	997	985
100	1001	1027	1071	1097	1085
110	1101	1127	1171	1197	1185

Dimensions of GUARD adjustable door frame [mm]:

	A	B	C	D	S
70	701	727	817	797	785
80	801	827	917	897	885
90	901	927	1017	997	985
100	1001	1027	1117	1097	1085
110	1101	1127	1217	1197	1185

# DOOR FRAMES DEDICATED TO FIRE COLLECTION

## EXECUTION STANDARD



**FIRE WOODEN**



**FIRE STEEL FIXED**

### FIRE FIXED STEEL

- fire steel fixed door frame is made of steel plate of thickness 1.5 mm, powder-coated in RAL COLOURS: white (9016), grey (7047), brown (8017), white (9003), graphite (7024).
- complete door frame includes four hinges, fire-resistant gasket.
- gaskets available in three colours - white, grey, brown.
- reinforcement for door closer.
- available dimensions – 60', 70', 80', 90', 100', 110'.
- double leaf door frames, other RAL colours as well as other custom features are subject to individual pricing.
- for colours RAL 7024, additional payment 5%.

### FIRE WOODEN

- fire wooden fixed door frame 100mm is made of wood, veneered with Classen Iridium decors and Classen CPL laminate.
- Complete door frame includes four hinges and gasket.
- W1 version - fire proof gasket in door frame strip.
- W2 version - smoke proof gaskets in wooden door leaf rebate and fire proof gasket in a door frame strip.
- available dimensions – 60', 70', 80', 90', 100', 110'.
- double leaf door frames and other custom features are subject to individual pricing.

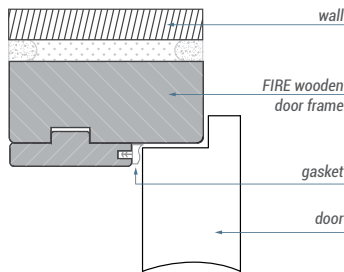

▲ FIRE WOODEN DOOR FRAME

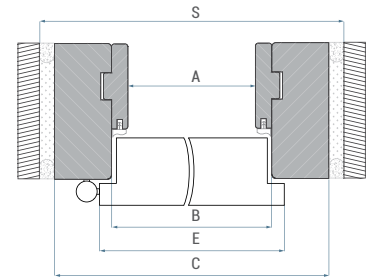
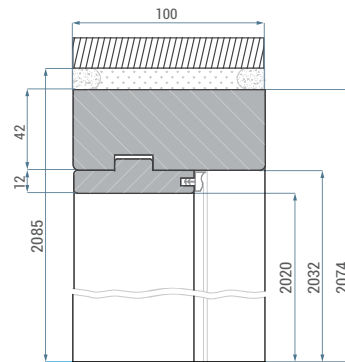

▼ FIRE FIXED STEEL DOOR FRAME

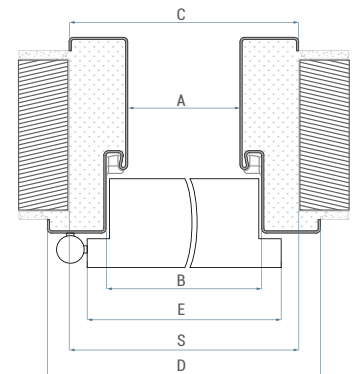
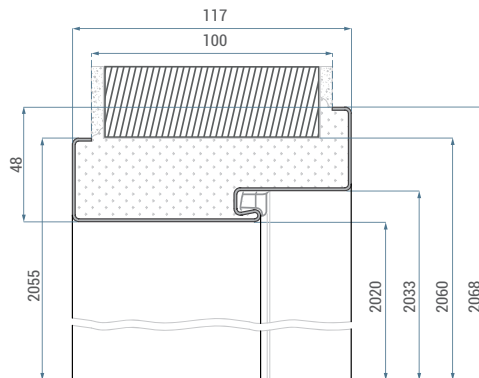
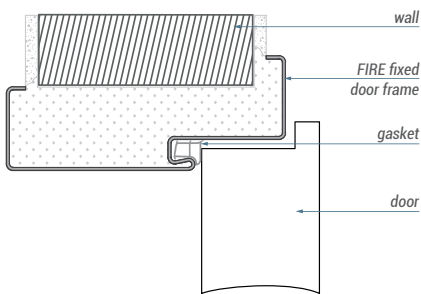

Dimensions of FIRE fixed door frame [mm]:

	A	B	C	D	E	S	
SINGLE LEAF	80	800	826	870	896	844	870
	90	900	926	970	996	944	970
	100	1000	1026	1070	1096	1044	1070
	110	1100	1126	1170	1196	1144	1170
DOUBLE LEAF	100	1035	1061	1105	1131	1079	1105
	110	1135	1161	1205	1231	1179	1205
	120	1235	1261	1305	1331	1279	1305
	130	1335	1361	1405	1431	1379	1405
	140	1435	1461	1505	1531	1479	1505
	150	1535	1561	1605	1631	1579	1605
	160	1635	1661	1705	1731	1679	1705
	170	1735	1761	1805	1831	1779	1805
DOUBLE LEAF	180	1835	1861	1905	1931	1879	1905
	190	1935	1961	2005	2031	1979	2005
	200	2035	2061	2105	2131	2079	2105

Dimensions of FIRE wooden door frame [mm]:

	A	B	C	E	S	
SINGLE LEAF	80	802	826	910	844	930
	90	902	926	1010	944	1030
	100	1002	1026	1110	1044	1130
	110	1102	1126	1210	1144	1230
DOUBLE LEAF	100	1040	1064	1148	1079	1170
	110	1140	1164	1248	1179	1270
	120	1240	1264	1348	1279	1370
	130	1340	1364	1448	1379	1470
	140	1440	1464	1548	1479	1570
	150	1540	1564	1648	1579	1670
	160	1640	1664	1748	1679	1770
	170	1740	1764	1848	1779	1870
DOUBLE LEAF	180	1840	1864	1948	1879	1970
	190	1940	1964	2048	1979	2070
	200	2040	2064	2148	2079	2170

# DOOR FRAMES DEDICATED TO TECHNICAL DOOR EI30 42 DB

## EXECUTION STANDARD



**FIXED MDF 42 DB**



**FIXED NON-REBATED  
MDF 42 DB**

### FIXED MDF 42 DB

Door frame is designed for internal rebated fire EI30 42dB and acoustic 42db door leaves. Door frame is made MDF board, covered with Classen Iridium veneer as well as Classen CPL laminate. Available in the following dimensions: 60' - 90'. Complete door frame includes four hinges and a gasket.

### FIXED NON-REBATED MDF 42 DB

Door frame is designed for internal non-rebated fire EI30 42dB and acoustic 42db door leaves. Door frame is made MDF board, covered with Classen Iridium veneer as well as Classen CPL laminate. Available in the following dimensions: 60' - 90'. Complete door frame includes four hidden hinges and a double set of gaskets.

Milling execution option for hidden door closer – no additional payment.

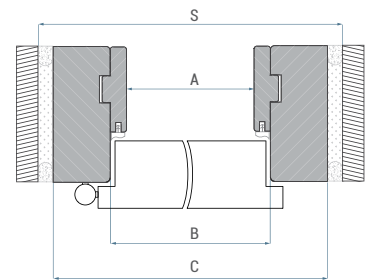
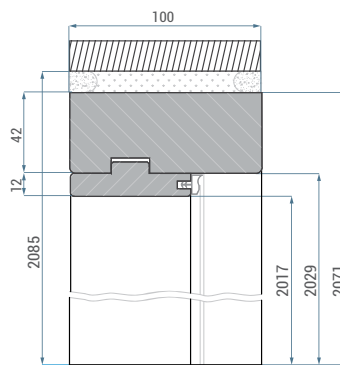
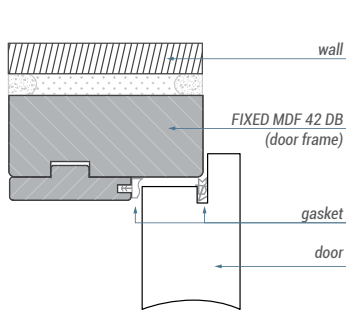

▲ **FIXED MDF 42 DB**

▼ **FIXED NON-REBATED MDF 42 DB**

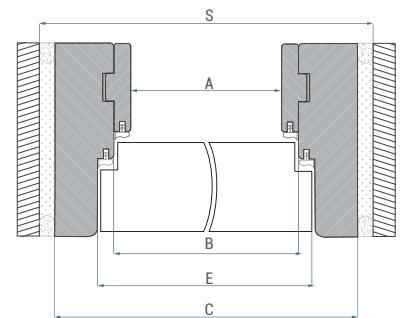
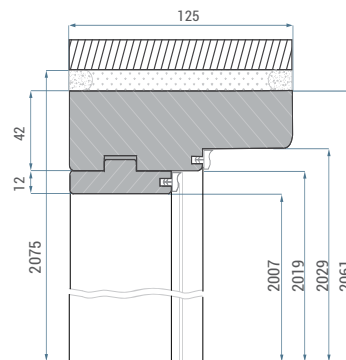
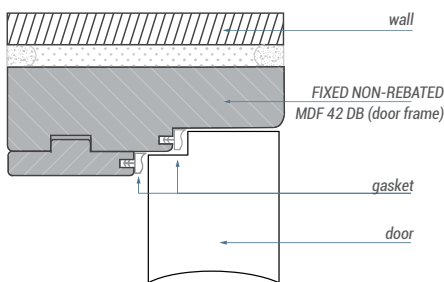

**Dimensions fixed MDF 42dB [mm]:**

	A	B	C	S
60	600	624	708	738
70	700	724	808	838
80	800	824	908	938
90	900	924	1008	1038

**Dimensions fixed non-rebated MDF 42dB [mm]:**

	A	B	C	E	S
60	638	662	750	686	780
70	738	762	850	786	880
80	838	862	950	886	980
90	938	962	1050	986	1080



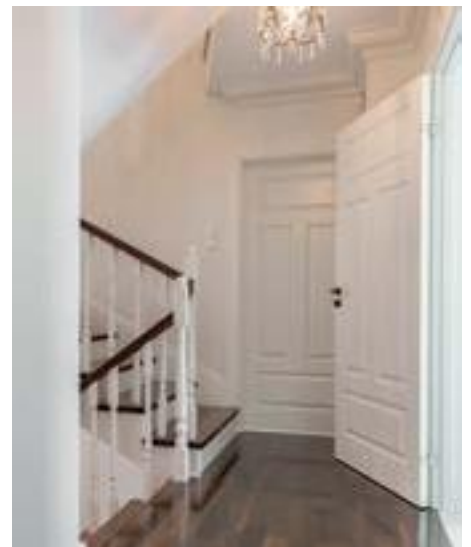

CORE



FILLING  
- HONEYCOMB INSERT



FILLING  
- PERFORATED CHIPBOARD



REINFORCED  
CLASSEN HARD CONSTRUCTION



CLASSEN HARD EDGE PF  
DOOR LEAF REBATE  
CONSTRUCTION



FRAMED CONSTRUCTION  
- structural elements connected  
with mounting pins

DOOR LEAF PROFILE



PROFIL K

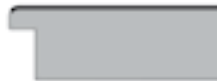

PROFIL R



PROFIL PF - POSTFORMING

VENTILATION



PASS-THROUGH VENTILATION  
sleeves with woodgrain overprint, available  
in decors corresponding to the veneers



METAL VENTILATION SLEEVES  
chrome-satin



PASS-THROUGH VENTILATION GRILLE  
made of plastic - various COLOURS\*)



PASS-THROUGH VENTILATION UNDERCUT \*)  
undercut 15 mm - for rooms with recuperation  
undercut 26 mm WC for doorr 80'-100' \*)  
undercut 38 mm WC for doors 60'-70' \*)

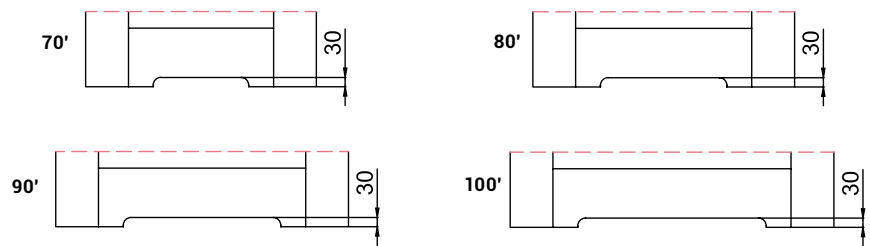

VENTILATION UNDERCUT SIZE IN FRAME \*\*)

\*) In line with applicable rules, ventilation area in the door leaf cannot be less than 0.022 m<sup>2</sup> for air flow.  
These requirements are fulfilled by our ventilation grille and ventilation undercut

\*\*) In the frame doors with a width of 70', 80', 90', ventilation undercut does not meet the required air throughput in accordance with applicable regulations.

DOOR NON-RABATED



HINGE 3D



STRIKE PLATE

DOOR RABATED

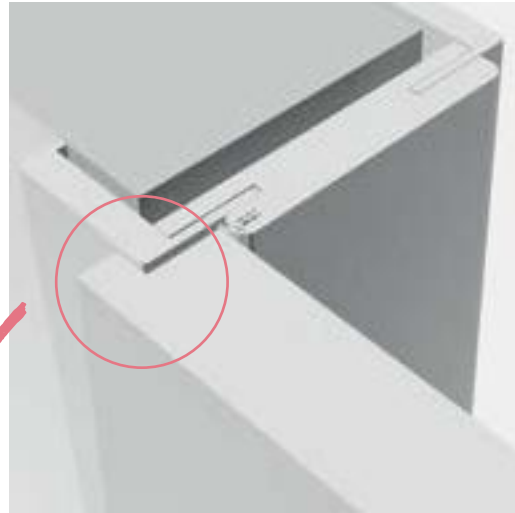

STRIKE PLATE



HINGE

DOOR OPENING DIRECTION

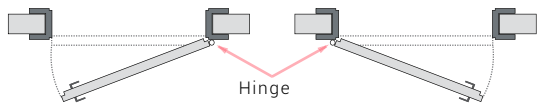

Single leaf door, **right**

Single leaf door, **left**



Sliding door, **right**

Sliding door, **left**



RIGHT

LEFT

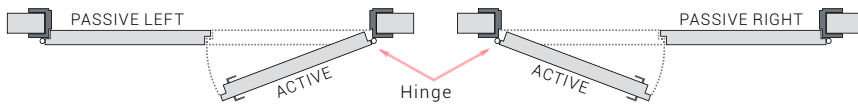

Double leaf door, **right**

Double leaf door, **left**

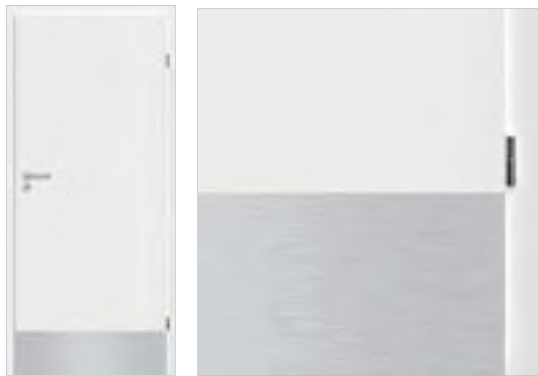

BOTTOM STEEL PANEL FULL

single-sided  
double-sided

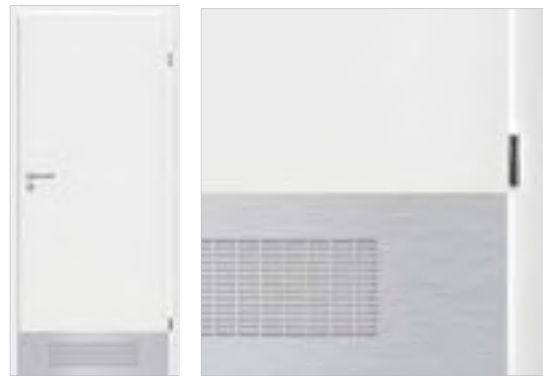

BOTTOM STEEL PANEL WITH VENTILATION

double-sided



TOP STEEL PANEL FULL

single-sided  
double-sided



VENTILATION GRILLE ALUMINIUM

double-sided



BULLSEYE WINDOW

Internal diameter - 240mm, white or transparent glass



STEEL PANEL, VERTICAL

with any room's number

REBATED DOOR LEAVES DIMENSIONS

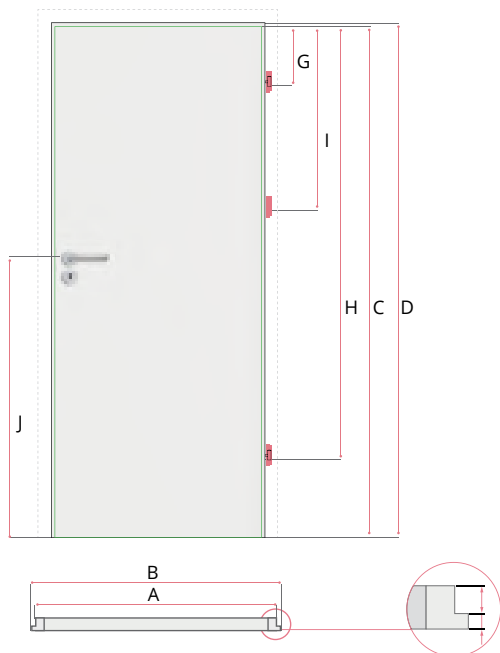

Dimensions [mm]	A	B
60	618	644
70	718	744
80	818	844
90	918	944
100	1018	1044
110	1118	1144
120	1218	1244
120	1253	1279
130	1353	1379
140	1453	1479
150	1553	1579
160	1653	1679
170	1753	1779
180	1853	1879
190	1953	1979
200	2053	2079

Dimensions [mm]	60-200
C	2020
D	2035
E	26
F	13
G	239
H	1719
I	777
J	1112

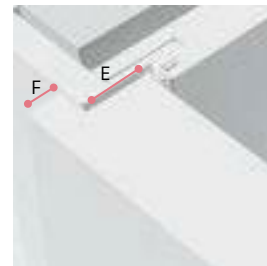

NON-REBATED DOOR LEAVES DIMENSIONS

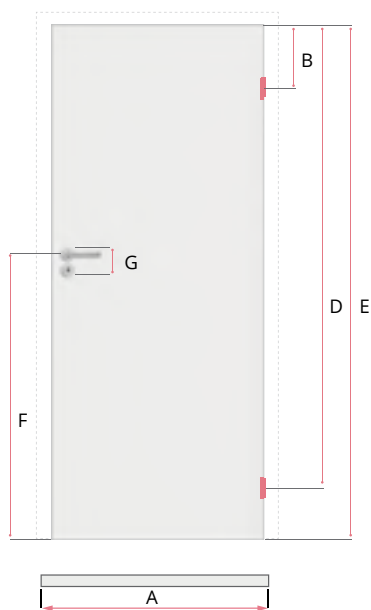

Dimensions [mm]	A
60	618
70	718
80	818
90	918
100	1018

Dimensions [mm]	70-100
B	275
D	1717
E	2022
F	1112
G	85 - patent 90 - wc 90 - key



SLIDING DOOR LEAVES DIMENSIONS

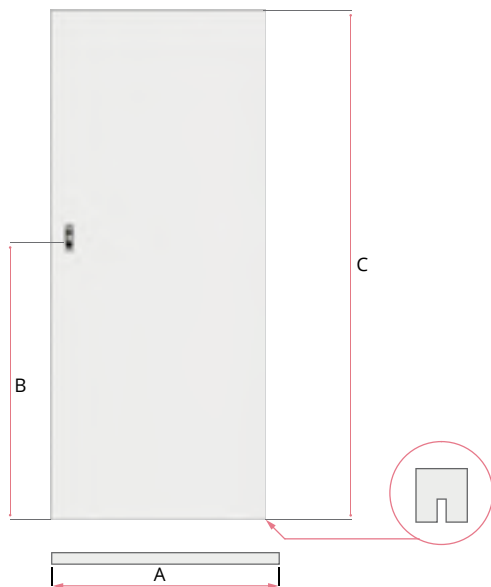

Dimensions [mm]	60-100
A	644, 744, 844, 944, 1044
B	977
C	2035

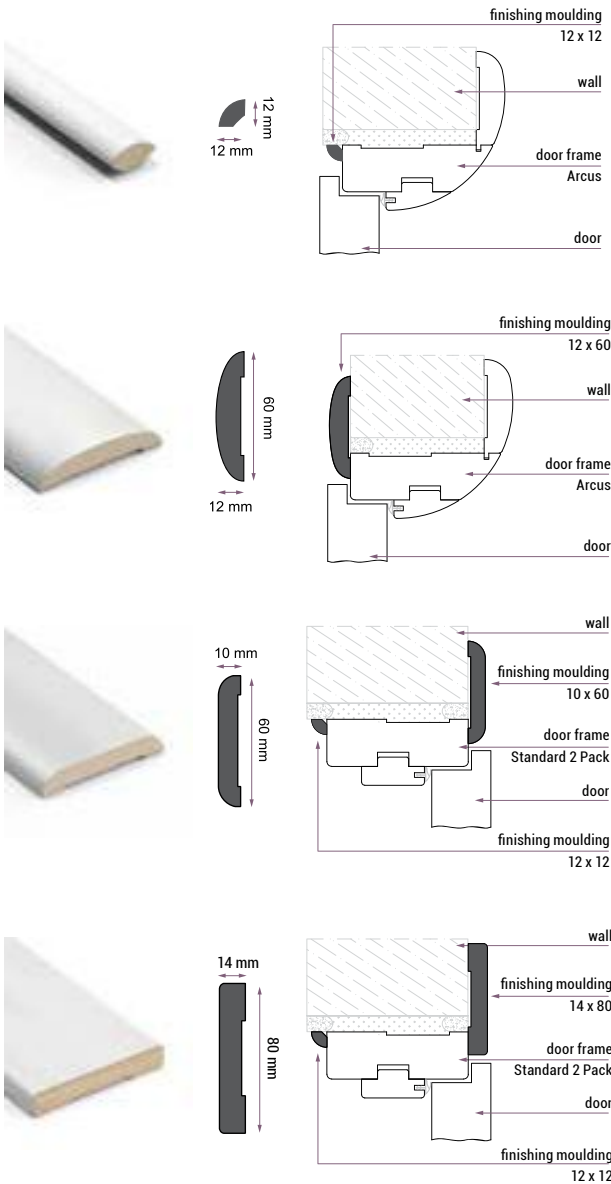

14x80 moulding can be also installed as a wall base moulding.

### Application:

Finishing mouldings are used for masking the places of connection between walls and a door frame. 14x80 moulding can be also installed as a wall base moulding.

It is possible to install finishing mouldings with small nails.

### Packing:

One package contains three finishing mouldings for re-cutting to match single or double leaf doors.

For single leaf door: 2x vertical element 2160 mm, 1x beam 1160 mm.

For double leaf door: 2x vertical element 2160 mm, 1x beam 2350 mm.

## REGULATORY STRIP WITH TONGUE 60 MM



### Application:

The strip is an optional element designed for adjustable door frame.

Regulatory strip with longer tongue increases the adjustment range by 17mm.

Dimension 100': **+20%**

Available in width 60'-90'

width 100' - +20%

## ADDITIONAL PAYMENT TO FINISH IN RAL COLOURS

Group	The colour number	Additional payment: frames, crown, mouldings
I	1013 1014 1015 7004 7032 7035 7038 7040 7044 7047 9001 9002 9003 9010 9016	+ 15%
II	1000 1001 1002 1011 1019 1020 1024 3009 3012 3015 3034 5012 5014 5015 5018 6021 6027 6034 7000 7002 7003 7005 7006 7009 7023 7030 7031 7034 7036 7037 7039 7042 7045 7046 8002 8017 8024 8025 9011	+ 20%
III	1003 1004 1005 1012 1017 1034 3000 3014 3017 3018 3022 4001 4002 4003 4005 4006 4008 4009 4010 5000 5001 5002 5003 5005 5007 5008 5009 5011 5013 5017 5019 5020 5021 5022 5023 6000 6003 6006 6008 6010 6011 6012 6014 6015 6016 6017 6020 6022 6024 6026 6028 6032 6033 7008 7013 7024 7026 8000 8001 8003 8004 8007 8008 8011 8014 8019 8022 8023 9005 9017	+ 25%
IV	1006 1007 1016 1018 1021 1023 1027 1028 1032 1033 2000 2001 2002 2003 2008 2009 2010 2011 2012 3001 3002 3003 3004 3005 3007 3011 3013 3016 3020 3027 3031 4004 4007 5004 6001 6002 6004 6007 6009 6018 6025 7016 8012	+ 35%

-) available in decors as for non-rebated adjustable door frame 80 (more on page 121)



CROWNS I

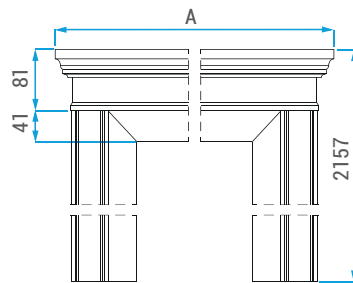

## CROWNS AND OVERLAY MOULDINGS

Crowns and overlay mouldings are intended for installation with Adjustable and Adjustable Non-rebated door frame (single door leaf). Not available with band 80. Surface finishing: PU lacquered.

RAL lacquered colours for additional payment.  
Additional payment table - **page 142**

CROWNS

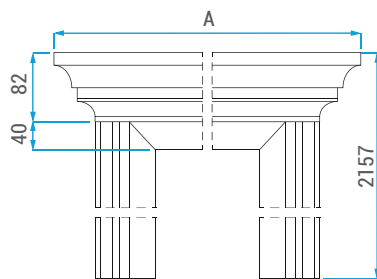

ADJUSTABLE Door frame	Dimension A (mm)			
	CROWN	CROWN I	OVERLAY MOULDING LN1	OVERLAY MOULDING LN2
60	900	843	800	
70	1000	943	900	
80	1100	1043	1000	
90	1200	1143	1100	
100	1300	1243	1200	

OVERLAY MOULDING II - LN2

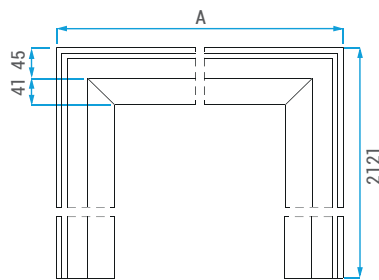

Moulding profile

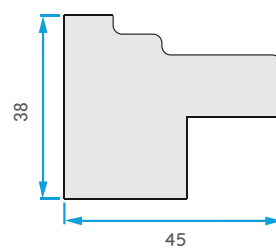

# ADDITIONAL ACCESSORIES

PVC ventilation sleeves: veneer colour with woodgrain overprint.



<b>Brown</b> 65000400	<b>Black</b> 65000500	<b>Dark Brown</b> 65000600	<b>Light Brown</b> 65000620	<b>Grey</b> 65000630	<b>Beige</b> 65000610	<b>Light Beige</b> 65100290	<b>Chocolate</b> 65000200
--------------------------	--------------------------	-------------------------------	--------------------------------	-------------------------	--------------------------	--------------------------------	------------------------------

PVC ventilation sleeves: matched to door leaves veneer colour with woodgrain overprint.



<b>Light Beige</b> 65100240	<b>White</b> 65100020	<b>Dark Beige</b> 65100080	<b>Brown</b> 65100010	<b>Dark Brown</b> 65100140	<b>Light Grey</b> 65900705	<b>Graphite</b> 65100252	<b>Chrome-Satin</b>
--------------------------------	--------------------------	-------------------------------	--------------------------	-------------------------------	-------------------------------	-----------------------------	---------------------

Metal ventilation sleeve:



**Chrome-Satin**

Kratki wentylacyjne z tworzywa sztucznego dopasowane do koloru klejony skrzydeł doorowych:



<b>Dark Brown</b> 66000700	<b>Orange</b> 66000400	<b>Light Beige</b> 66000600	<b>White</b> 66000100	<b>Dark Beige</b> 66000200	<b>Grey</b> 66000900	<b>Graphite</b> 66011726
-------------------------------	---------------------------	--------------------------------	--------------------------	-------------------------------	-------------------------	-----------------------------

VENTILATION:



**Ventilation grille**  
made of aluminium for  
technical door

LOCK:

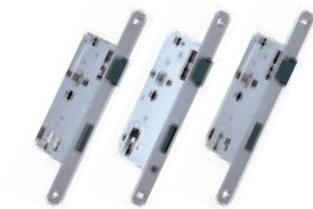

**Lock for rebated door**  
left and right version  
lock for regular key / cylinder lock /  
bathroom key (4x4)



**Magnetic lock for non-rebated  
door leaves**  
lock for regular key / cylinder lock /  
bathroom key (6x6)



**Hook lock for sliding  
door leaves**  
lock for regular key /  
bathroom key



**Bolt lock**  
bottom BORD  
left / right



**Bolt lock top BORD**



**Fire door lock**



**Cylinder lock**  
Designed for cylinder locks,  
26/36 mm



**Set of cylinder locks**  
Designed for cylinder locks,  
26x40, class II (BORD W3)





**3D hinge for non-rebated door**

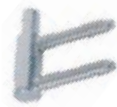

**Door frame hinge**



**Door hinge diameter**



**Fire hinge for wooden door frame**



**Fire hinge/Guard steel door frame**



**Wall stop**  
66995000 cone nickel



**Odbojnik ścienny**  
66994000 square nickel



**Floor stop**  
66992000 spherical nickel



**Floor stop**  
6991000 spherical grafiatto bronze



**Peephole**  
nickel



**Peephole**  
grafiatto bronze

Round PVC for sliding doors



**White round**



**Silver round**



**Beige round**



**Bronze round**



**Golden round**



**Door pulls for sliding doors**  
Steel: grafiatto bronze  
1 pcs.



**Door pulls for sliding doors**  
Steel: silver (INOX)  
1 pcs.



**Railing**  
for DESIGN sliding doors system, stainless steel  
500/300 mm 1 pcs.



**PVC hinge covers (panel doors)**  
diameter 13.5 mm.  
Colours: chrome, satin chrome



**Surface DC140 door closer**  
with standard arm for fire door



**DC135 door closer**  
with sliding rail for fire door



**Door closer**  
for sliding doors system

# HANDLES

## AMSTERDAM - ANTIBACTERIAL HANDLE

natural aluminum,  
satin



Door handle with  
standard rosette



Door handle with  
cylinder lock  
rosette



Door handle with  
bathroom lock  
rosette



Covered with silver ions, it creates an antibacterial coating Secu San

## IKKO

chrom, application black.



Door handle with  
standard rosette



Door handle with  
cylinder lock  
rosette



Door handle with  
bathroom lock  
rosette



chrom

## POLARIS

chrom, application white.



Door handle with  
standard rosette



Door handle with  
cylinder lock  
rosette



Door handle with  
bathroom lock  
rosette



chrom

## SEDAR

nickel.



Door handle with  
standard rosette



Door handle with  
cylinder lock  
rosette



Door handle with  
bathroom lock  
rosette



nickel

## JEZZ

nickel.



Door handle with  
standard rosette



Door handle with  
cylinder lock  
rosette



Door handle with  
bathroom lock  
rosette



nickel

**ANTI-HANDLE HANDLE**

stainless steel.



Door handle on short escutcheon



Standard rosette



Cylinder lock rosette



Bathroom lock rosette



stainless steel

**FOKUS QR**

titanium.



Door handle on short escutcheon



Standard rosette



Cylinder lock rosette



Bathroom lock rosette



titanium

**ROMANA**

grafiato bronze  
chrom / nickel.



Door handle on short escutcheon



Standard rosette



Cylinder lock rosette



Bathroom lock rosette



chrom / nickel



grafiato bronze

**MINIMAL RT**

nickel.



Door handle on short escutcheon



Standard rosette



Cylinder lock rosette



Bathroom lock rosette



nickel

**PALERMO QR**

nickel.



Door handle on short escutcheon



Standard rosette



Cylinder lock rosette



Bathroom lock rosette



nickel

# HANDLES

## QUBIK QR nickel, titanium.



Door handle on short escutcheon



Standard rosette



Cylinder lock rosette



Bathroom lock rosette



nickel



titanium

## JANE QR nickel.



Door handle on short escutcheon



Standard rosette



Cylinder lock rosette



Bathroom lock rosette



nickel

## SIGMA QR stainless steel, satin.



Door handle on short escutcheon



Standard rosette



Cylinder lock rosette



Bathroom lock rosette



satin



stainless steel

## PRADO stainless steel, satin.



Door handle on short escutcheon



Standard rosette



Cylinder lock rosette



Bathroom lock rosette



satin



stainless steel

## DIANA QR chrom satin



Door handle on short escutcheon



Standard rosette



Cylinder lock rosette



Bathroom lock rosette



chrom satin

**ALMA ECO**  
grafiatto bronze,  
nickel.



**JANE KK**  
grafiatto bronze,  
chrom / nickel.



**HAGA**  
brown,  
black,  
inox.

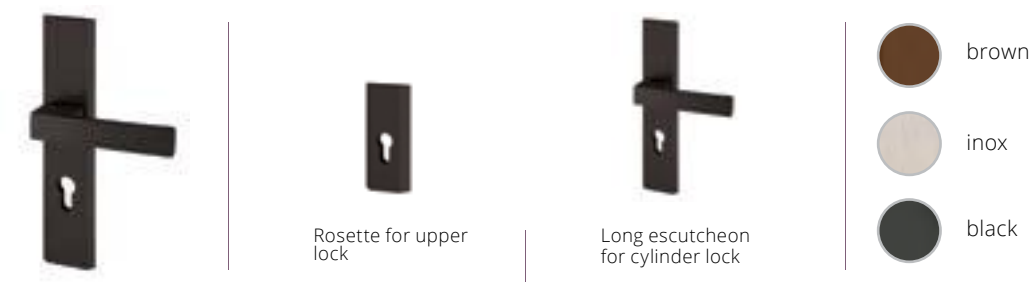

**NIAGARA**  
inox,  
brown.

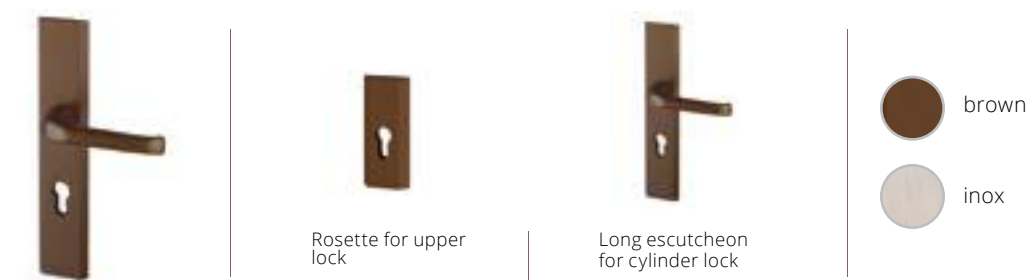

**ONTARIO klasa II**  
inox.

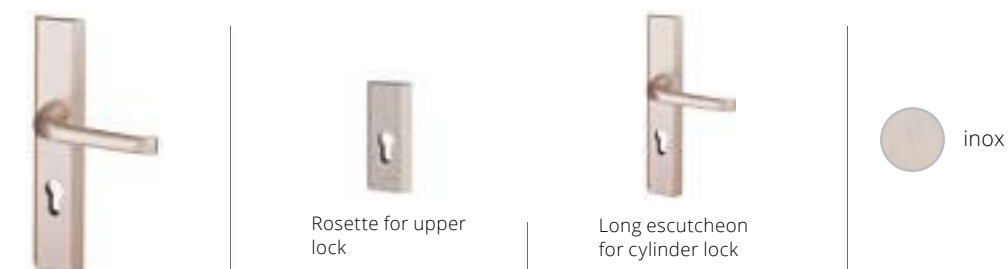

PRIMO



Acacia ST

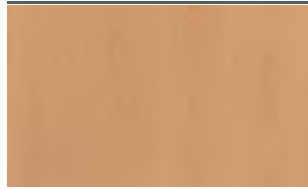

Beech



Walnut



Polish Oak



Natural Oak

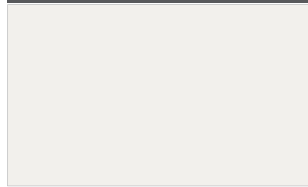

White

3D LOOK

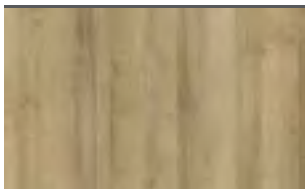

Riviera Oak



Anthracite Oak



Light Columbia Walnut



Oiled Oak

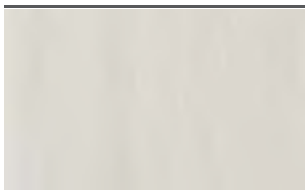

White Ash

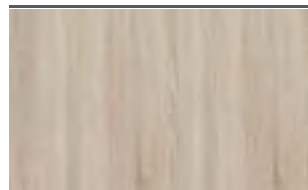

Sonoma Oak

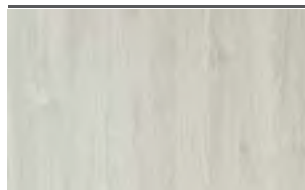

Grey Oak

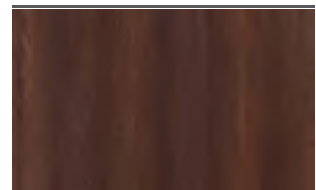

Burnt Oak

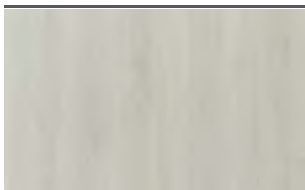

Nordic Oak

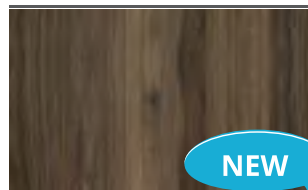

Catania Oak

NEW

LACQUER



White - lacquered  
close to RAL 9003

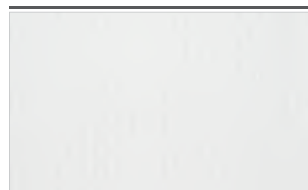

White - lacquered  
with structure

IRIDIUM



White matt

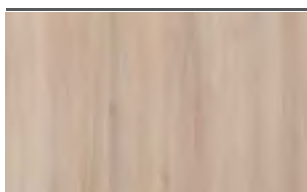

Snow Ash

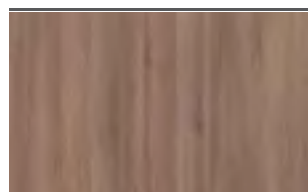

Brown Ash

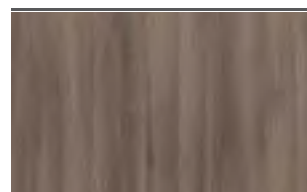

Graphite Ash

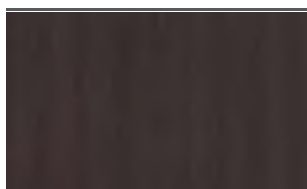

Wenge

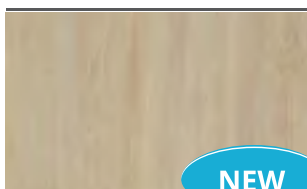

Marone Oak

NEW



Grey matt

NEW

CPL



Acacia

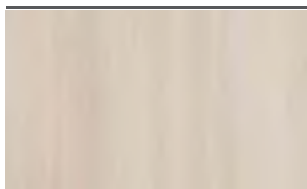

Acacia light

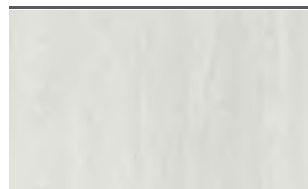

Norwegian Ash

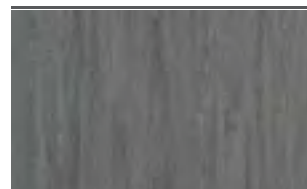

Grigio Oak

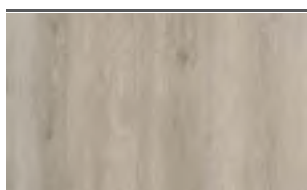

Kendal Oak

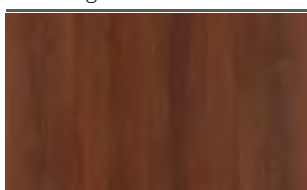

Italian Walnut

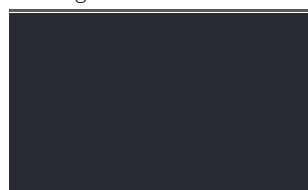

Graphite RAL 7024



Grey RAL 7047

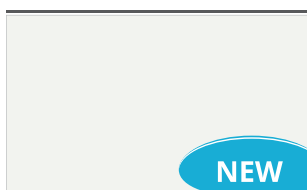

White RAL 9003

NEW

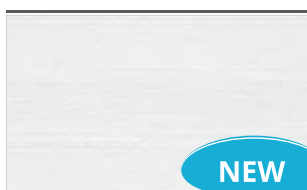

White structure horizontal

NEW

HPL



Graphite RAL 7024

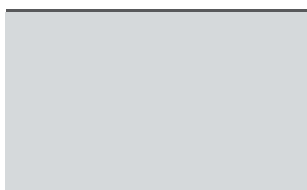

Grey RAL 7047

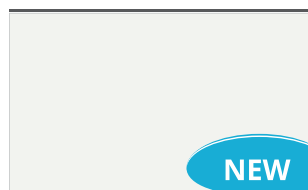

White RAL 9003

NEW

# DECORS HPL CUSTOM OFFER

Available for individual design enquiries.  
Details at Customer Service.

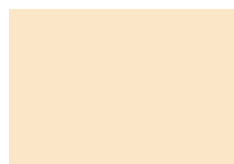

**Cotton**  
U113 - NCS S0907-Y30R



**Vibrant Yellow**  
U114 - NCS S1060-Y10R



**Citrus Yellow**  
U131 - NCS S0560-G90Y



**Sand Beige**  
U156 - NCS S1505-Y50R



**Curry Yellow**  
U163 - NCS S2060-Y10R



**Silicon Grey**  
U201 - NCS S3502-Y

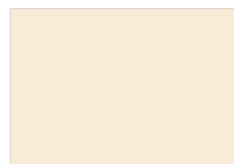

**Came Beige**  
U216 - NCS S0502-Y50R



**Burgundy**  
U311 - NCS S5040-R



**Chinese Red**  
U321 - NCS S1580-Y90R



**Chilli Red**  
U323 - NCS S3060-R



**Aubergine**  
U330 - NCS S7010-R30B



**Blue Horizon**  
U522 - NCS S1030-R80B



**Faience Blue**  
U525 - NCS S3060-R90B



**Blue Indigo**  
U599 - NCS S8505-R80B



**Kiwi Green**  
U626 - NCS S3050-G40Y



**Lime Green**  
U630 - NCS S1060-G40Y



**Niagara Green**  
U646 - NCS S5030-B30G



**Kashmir**  
U702 - NCS S2005-Y60R

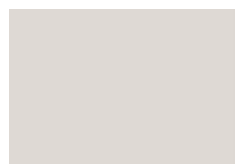

**Silky Grey**  
U707 - NCS S1500-N



**Light Grey**  
U708 - NCS S2000-N



**Stone Grey**  
U727 - NCS S4005-Y50R



**Dust Grey**  
U732 - NCS S5000-N



**Grey Lava**  
U741 - NCS S7005-Y20R



**Taupe Grey**  
U750 - NCS S2005-Y20R



**Pearl Grey**  
U763 - NCS S2500-N



**Silky Brown**  
U767 - NCS S6005-Y20R

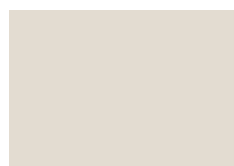

**Silky White**  
U775 - NCS S1000-N



**Artic Grey**  
U788 - NCS S4500-N



**Czerń aksamitna**  
U899 - NCS S8500-N



**Grey Onyx**  
U960 - NCS S6500-N



**Graphite Grey**  
U961 - NCS S8000-N



**Diamond Grey**  
U963 - NCS S7500-N

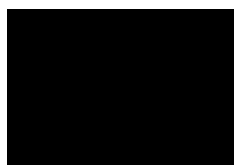

**Black**  
U999 - NCS S9000-N

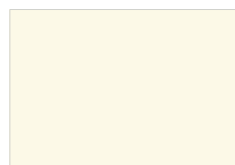

**White**  
W911 - NCS S0502-G50Y

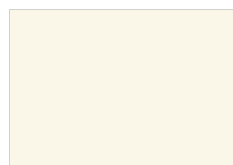

**Platinum White**  
W980 - NCS S0300-N

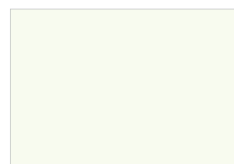

**Premium White ST22**  
W1000 - NCS S0500-N

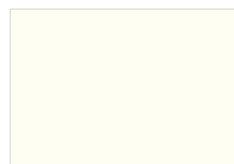

**Premium White solid**  
W1001 - NCS S0500-N

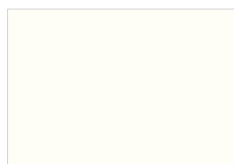

**Alpine White**  
W1100 - NCS S0502-R50B



# DECORS HPL CUSTOM OFFER

Available for individual design enquiries.  
Details at Customer Service.



**Dark Grey Chicago Concrete**  
F187



**Light Concrete**  
F274



**Inox metallic**  
F500



**Aluminium**  
F509



**Black and Gold Metallic Slate**  
F629



**Gray-Beige Bamenda**  
H1115



**Natural Bardolino Oak**  
H1145



**Arizona Grey Oak**  
H1150



**Navarra Ash**  
H1250



**Natural Branson Robinia**  
H1251



**Truffle Branson Robinia**  
H1253



**Light Lakeland Acacia**  
H1277



**Natural Wild Oak**  
H1318



**Sorano Light Oak**  
H1334



**Graphite Denver Oak**  
H1387



**Ellmau Beech**  
H1582



**Verona Cherry**  
H1615



**Lincoln Walnut**  
H1714



**Mali Wenge**  
H3058



**Shorewood**  
H3090



**Corbridge Grey Oak**  
H3156



**Vicenza Oak**  
H3157



**Vicenza Grey Oak**  
H3158



**Kendal Natural Oak**  
H3170



**Anthracite Finition Metallic**  
H3190



**Brown Finition Metallic**  
H3192

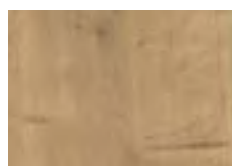

**Natural Hamilton Oak**  
H3303



**Nebraska Grey Oak**  
H3332



**Natural Cordbridge Oak**  
H3395



**White Aland Pine**  
H3430



**Polar Aland Pine**  
H3433



**White Fleetwood**  
H3450



**Champagne Fleetwood**  
H3451



**Fleetwood Grey Lava**  
H3453



**Natural Pacific Walnut**  
H3700



**Natural Hickory**  
H3730



**Natural Dijon Walnut**  
H3734



**Natural Mandal Maple**  
H3840



**Premium White ST19**  
W1000\_ST19

Art. nr 60010455



The catalogue does not constitute an offer within the meaning of commercial law.  
Classen-Pol S.A. reserves the right to change and improve the products presented in this publication without prior notice.  
Information contained in this catalogue is correct at the time of publishing.  
Colours presented in this catalogue may differ from the products that are on sale.

Your salesperson:

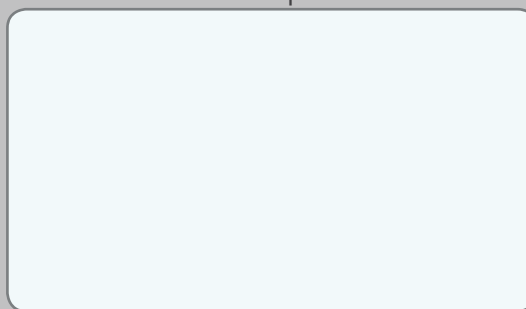

e-mail: [biuro@classen.com.pl](mailto:biuro@classen.com.pl)  
[www.classen.pl](http://www.classen.pl)

**CLASSEN**

**Classen-Pol S.A.**

ul. Wyzwolenia, 44-292 Zwonowice k. Rybnika  
tel.: +48 (32)429 20 00

CLASS. 01.2021/ENG