



2025 2025 2025 2025
2026 2026 2026 2026



umaService / umaService	10-11
-------------------------	-------

Erläuterungen / Descriptions	12-13
-------------------------------------	--------------

Produkt-Info-Skizzen – Druckpositionen – Druckverfahren – Hinweise zu Farb-Codes
 Informative Product Sketches – Print Positions – Printing Methods – Notes on the colour codes



uma NEWS	14-19
-----------------	-------

Besonderheiten / Speciality

	umaPRIME	20-21
	uma – rPET	26-58
	uma – Antibakteriell/antibacterial	50-51
	uma NFC	102-107
	uma GUMON!	112-115
	uma QR-CODE	122-123
	uma BlackForest-Pens	138-141
	uma VISUAL	160-165
	uma Farbvielfalt/uma variety of colours	182-185
	uma Glänzend werben/uma promote brilliant	228-231

























Natur / Natural	22-99
------------------------	--------------





















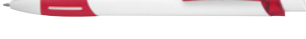

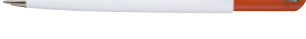
	BEECH	87
	BIO PEN	93
	CETA RECY	79
	CHILL C RECY	77
	ELEGANCE WOOD	90-91
	FOREST	87
	GROOVE RECY	98-99
	HAPPY RECY	68-69
	ICONIC RECY	72-73

	LEAF	85
	LUMOS RECY	96-97
	ON TOP RECY	70-71
	PAPER PEN	92-93
	PIXEL RECY	76
	POP RECY	75
	RECYCLED PET PEN	56-57
	RECYCLED PET PEN ALUMA	54-55
	RECYCLED PET PEN CHANGE	26-27
	RECYCLED PET PEN FUTURE	28-31
	RECYCLED PET PEN PRO	34-53
	RECYCLED PET PEN STEP	32-33
	RECYCLED PET PEN switch	58
	ROOT	82-83
	STRAIGHT GUM RECY	94-95
	TRINITY RECY	64-67
	TREE	84-85
	TITAN WOOD	88-89
	ULTIMATE RECY	78-79
	VANE RECY	74
	VITAN RECY	60-61
	WOODY	86
	YES antibacterial	59
	YES RECY	59

Kunststoff/Plastic









100-207







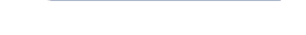



	ARCTIS	179
	BEAT	135
	BLOOM	186-187
	CANDY	168-171
	CETA	151
	CHECK	142-143
	CHIC	150
	CHILL	144-145
	CORAL	116-119
	CRYSTAL	152-153
	EFFECT	196-197
	ENERGY	167
	FANTASY	166
	FASHION	162-163
	FLEXI	207
	GEOS	154-155
	HAPPY	130-131
	ICON	200-201
	ICONIC	198-199
	JAZZ	178
	KLIKK	174-175
	LINEO	124-125
	LOOK	172-173
	MEMORY	158-159
	OMEGA	156-157

	ON TOP	188-191
	PEPP	148
	PIXEL	202-203
	POP	194-195
	PRIMA	137
	PUR	176-177
	QUANTUM	180-181
	RINGO	204-205
	SKY	108-111
	SPOT	149
	STREAM	120-121
	STRIPE	172
	SUNNY	166
	TORSION	206
	TRINITY	102-107
	TWISTY	134
	ULTIMATE	147
	ULTIMO	146
	UP	132-133
	VANE	192-193
	VIANI	206
	VOGUE	164-165
	X-DREAM	136
	YES	126-129

Metall/Metal









208-269

	2in1	266-267
	ARGUS L	255
	BRIGHT	234-235
	BRUSH	232-233
	CLASSICO	226
	COMMA	257
	COSMOS	256
	ELEGANCE	220-221
	ELLIPSE	236-237
	ETERNITY	223
	GALILEO C	222
	LUCKY	257
	LUMOS	246-249
	MESH	212-213
	MOOD	210-211
	MOON	254
	NOBILIS	222
	OPERA	227
	PRIMUS	250-251
	PYRA	244-245
	RONDO	256
	SHADOW	262-263
	SIX	252
	SKINNY TOUCH	268-289

	SLIDE	264-265
	SLIMLINE	260-261
	SMOKE	253
	SOUL	224-225
	STRAIGHT	238-243
	SUPREME	258-259
	TAROT	255
	TITAN	218-219
	VENUS	254
	VIP	216-217
	VIPOLINO	214-215











Highlighter/Highlighter

270-277

	LIQEO HIGHLIGHTER	272-273
	LIQEO HIGHLIGHTER MINI	274
	LIQEO HIGHLIGHTER PEN	275
	LIQEO HIGHLIGHTER MINI SET	274
	LIQEO HIGHLIGHTER PEN SET	275
	LIQEO HIGHLIGHTER SET	273
	TEXTMARKER	276
	TEXTMARKER 2er SET	276
	TEXTMARKER SET	277
	TEXTMARKER SET SI	277

Zubehör/Accessoires

278-289

	DESK	282
	DREIECKSVERPACKUNG/TRIANGULAR ETUI	281
	ETUIS	284, 286-289
	KISSENVERPACKUNG/PILLOW PACK	281
	QUARTER	282
	RECYCLED PET BOX	283
	SET BOX	280
	SQUARE	280
	TUBE	282
	PAPPSTECKETUI/ CARDBOARD SLIP-IN-CASE	284-285

Minen/Refills

290-297

	MINEN	293-297
---	-------	---------

Erläuterungen/Descriptions

298-313

Druck & Veredelungen/Printing & Finishing	298-303
---	---------

Lasergravuren/Laser Engravings	304-305
--------------------------------	---------

Numerisches Inhaltsverzeichnis/Numerical Table of Contents	306-311
--	---------

Bei uma wird SERVICE großgeschrieben

Wir von uma legen viel Wert auf unseren Kundenservice, daher möchten wir Sie bestens beraten und Sie bei der Abwicklung Ihres Kundenauftrages bestmöglich unterstützen. Wir stehen Ihnen jederzeit zur Verfügung, um Ihre Fragen zu beantworten, Probleme zu lösen und Ihre Anliegen schnell und zuverlässig zu bearbeiten. Zögern Sie daher nicht, uns zu kontaktieren.



umaPRIME

Sie brauchen Ihre Ware schneller?

Nicht nur bei den ausgewählten umaPRIME-Modellen können wir Ihnen eine verkürzte Lieferzeit anbieten. Rufen Sie uns gerne an und besprechen Sie den gewünschten Liefertermin mit uns.



umaPRODUKTKONFIGURATOR

Sie suchen ein ganz bestimmtes Schreibgerät?

Wir helfen Ihnen gerne, das passende Modell zu finden. Geben Sie uns einfach die Kriterien Ihres Kunden weiter – egal ob es ein Preissegment, die gewünschte PMS-Farbe oder verschiedene Merkmale wie Kunststoff, Metall oder nachhaltige Produktlösungen sind. Wir schauen gerne für Sie nach, welche passenden Modelle wir in unserem Produktprogramm haben.



umaMUSTER-SERVICE

Ihnen fehlt das passende Handmuster zum Angebot?

Geben Sie uns gerne Bescheid. Bei Bedarf senden wir Ihnen die Muster auch direkt zu Ihren Kunden. Somit kann unser Kugelschreiber für sich sprechen.

Sie brauchen noch schnell Originaldrucke für Ihren Kunden?

Wir realisieren für Sie Ihr Andruckmuster, damit Ihr Kunde sehen kann, wie wir seine Werbung auf den Kugelschreiber anbringen.



umaPMS-SERVICE

Sie brauchen einen Kugelschreiber in Sonderfarbe?

Bei uns haben Sie nicht nur die Möglichkeit ein Modell farblich zu kombinieren, sondern auch in Ihrer gewünschten Sonderfarbe einzufärben.



umaSMALL ORDER-SERVICE

Sie haben eine kleine Abnahmemenge?

Kein Problem, bei uns können Sie auch kleinere Stückzahlen unter 1.000 Stück bestellen.



umaSUSTAINABILITY

Ihr Kunde setzt auf Nachhaltigkeit?

Wir bieten eine vielfältige Auswahl an nachhaltigen Materialien. Von rPET, rAL, rABS, rPCP, METALL RECY bis hin zu Holz, Cellulose und Karton. Bei uns finden Sie die komplette Bandbreite.

SERVICE is a top priority at uma

At uma, we attach great importance to our customer service, this is why we want to give you the best possible advice and assist you in processing your customer order. We are always at your disposal to answer your questions, solve problems and to process your requests quickly and reliably. Please do not hesitate to contact us.

umaPRIME

Do you need your goods faster?

We offer you a shorter delivery time not only for the selected umaPRIME products. Please give us a call and discuss the desired delivery date with us.

umaPRODUCT CONFIGURATOR

Are you looking for a specific writing instrument?

We will be happy to help you find the right item. Simply let us know your customer's criteria - whether it's a price segment, the desired PMS colour or various features such as plastic, metal or sustainable product solutions. We will be happy to check which suitable items we have in our product range for you.

umaSAMPLE SERVICE

Are you missing the right sample for your offer?

Please let us know. If required, we can also send the samples directly to your customer. This allows the customer to convince himself of the pen.

Do you need original samples urgently for your customer?

We will be happy to produce original samples to show your customer how we will apply their advertising to the pen.

umaPMS-SERVICE

Do you require pens produced in special colour?

We not only offer you the option of combining items in different colours, but also in your desired special colour.

umaSMALL ORDER SERVICE

Do you have a small order quantity?

No problem, you can also order smaller quantities of less than 1,000 pieces.

umaSUSTAINABILITY

Does your customer focus on sustainability?

We offer a wide range of sustainable materials. From rPET, rAL, rABS, rPCP, METAL RECY through to wood, cellulose and cardboard. You will find the complete range with us.



umaCUSTOMER-SERVICE

Brauchen Sie Unterstützung?

Mit unseren praktischen Verkaufshilfen wie Flyer, Musterboxen und Filmen sind Sie bestens vorbereitet. Auf Wunsch erstellen wir Ihnen auch individuelle Präsentationen für Ihre Kundenprojekte. Doch damit nicht genug – bei Ihrer Eigenwerbung stehen wir Ihnen ebenfalls zur Seite.



myCALCULATOR

Brauchen Sie beim Kunden schnell einen Preis?

Kein Problem! Mit unserem praktischen myCalculator können Sie Ihr Schreibgerät im Handumdrehen durchrechnen und die Kalkulation speichern. So haben Sie jederzeit und überall Zugriff auf Ihre Preise – schnell, einfach und zuverlässig.



myUMA

Haben Sie schon gewusst, dass unser Händlerportal myUMA Ihren Berufsalltag erleichtert und vereinfacht?

Schauen Sie gerne mal rein und fragen Sie gerne telefonisch oder per Mail nach, wenn Sie Hilfe brauchen.

umaCUSTOMER-SERVICE

Do you need support?

With our practical sales aids such as flyers, sample boxes and videos, you are well prepared. On request, we can also create individual presentations for your customer projects. But that's not all – we can also help you with your own promotion.

myCALCULATOR

Do you need a price quickly for your customer?

No problem! With our practical myCalculator you can easily calculate your writing instrument and save the calculation. So you have access to your prices anytime and anywhere – quickly, easily and reliably.

myUMA

Did you know that our myUMA portal makes your daily work easier and less complicated?

Please have a look and feel free to call or email us if you need help.



Große Vielfalt, schneller Überblick

Die uma Schreibgeräte setzen sich aus vielen Komponenten zusammen, mit einer Vielfalt an Farb-Optionen und unterschiedlichen Druckpositionen. Zur schnellen Übersicht über die verfügbaren Gestaltungsmöglichkeiten finden Sie auf jeder Produktseite eine Produkt-Info-Skizze mit dem jeweiligen Schreibgerät, der gesamten Auswahl an Standard-Farben des Modells und den Angaben der zur Verfügung stehenden Druckpositionen mit entsprechenden Maßen (Länge x Höhe in mm).

Für die Beschreibung der Druckposition und der Druckverfahren gibt es spezielle Info-Schlüssel, vgl. unten. Bitte achten Sie auf die Nummer (①–⑦) der jeweilig verfügbaren Druckposition bzw. auf den Buchstaben (Druckschlüssel S, T, TT, L, RD, RL, EL, HD, V, D, MS, MT, P, GS, GT) des entsprechend geeigneten Druckverfahrens. uma – große Vielfalt, schneller Überblick.

Produkt-Info-Skizzen (Aufbau)

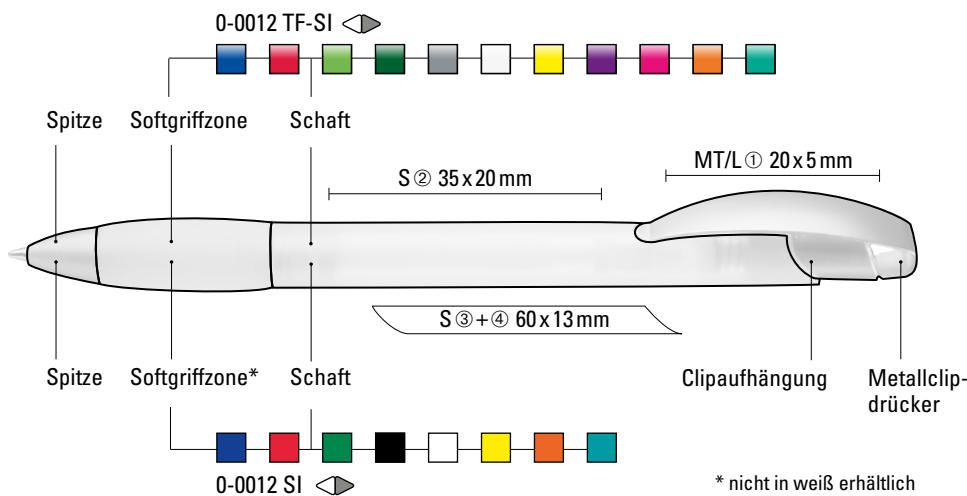

Gedechte Farben, Beispiele:



Gefrostete Farben, Beispiele:



Transparente Farben, Beispiele:



Druckpositionen

- ① auf dem Clip
- ② in Clipverlängerung
- ③ gegenüber dem Clip
- ④ seitlich vom Clip
- ⑤ auf der Kappe / auf dem Oberteil
- ⑥ Stopfen
- ⑦ seitliche Clipbefestigung

Druckverfahren (Druckschlüssel)

- S = Siebdruck
- T = Tampondruck
- TT = Tampondruck auf Sonderformaten
- L = Lasergravur
- EL = Einzelnamensgravur
- RD = Relieffdruck
- RL = Rundumlasergravur
- HD = Digitaldruck
- V = Visual-Folientransferdruck
- D = Doming

- Tampon- oder Siebdruck auf Metall, Holz oder lackierten bzw. gummierten Oberflächen:
- MS = Siebdruck auf Metall
- MT = Tampondruck auf Metall
- P = Sonderdruck
- GS = Siebdruck auf gummierten Oberflächen
- GT = Tampondruck auf gummierten Oberflächen

○ Rundumdruck möglich

□ = Etikettendruck möglich

◀▶ Mix and Match Modell

◊ = Uni-Modell

Hinweise zu Farb-Codes

Die komplette Farbauswahl der Produkte wurde in Form von Einklinkern abgebildet. Die dazugehörigen Farbcodes setzen sich so zusammen, dass die letzten vier Ziffern der jeweiligen PMS-Farbe entsprechen. Basierend auf den Nummern des Pantone-Farbfächers.

Da es sich hierbei um unverbindliche Angaben handelt, bitte vor einer Bestellung die Originalmuster zur Freigabe anfordern. Wichtig: Zu jeder Bestellung die Farbnummern angeben!

Farb-Code/Minen	
Artikelnummer →	0-0133 (● 8-0855)
	0-0133 SI (● 8-0855)
	50-0002
	50-0001
	↑ Farb-Code



The Whole Range At A Glance

The uma writing instruments combine numerous components with a wide range of colour options and various print positions. With all these design choices, it's a good thing every product page has an informative product sketch of each writing instrument, the full range of standard colours for the model and information about available imprint positions with dimensions (length x height in mm).

There are special information codes describing imprint positions and printing methods – see below for more. Please note the number (①–⑦) of the available imprint position and the letter (printing code S, T, TT, L, RD, RL, EL, HD, V, D, MS, MT, P, GS, GT) of your chosen printing method. At uma, you can see the whole range at a glance.

Informative Product Sketches (Structure)

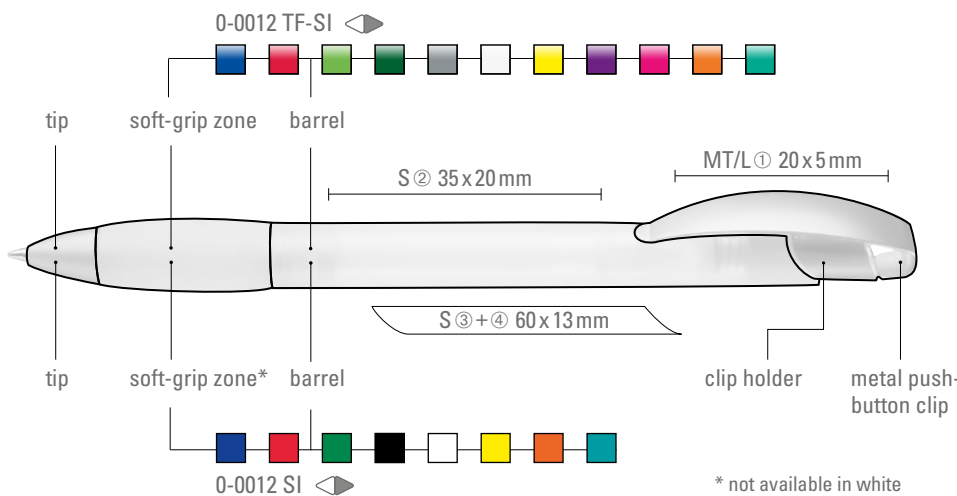

Solid Colours, Examples:



Frosted Colours, Examples:



Transparent Colours, Examples:



Print Positions

- ① On the clip
- ② In front of the clip
- ③ On the opposite side of the clip
- ④ Beside the clip
- ⑤ On the cap/ on the upper part
- ⑥ Plug
- ⑦ Lateral clip fastening

- All-around imprint
- ◀▶ Mix and Match Model

Printing Methods (Printing Code)

- S = Silk screen
- T = Pad printing
- TT = Pad printing on special formats
- L = Laser engraving
- EL = Individual name engraving
- RD = Relief printing
- RL = 360° Laser engraving
- HD = Digital printing
- V = Foil transfer imprint
- D = Doming



- = Print on inner barrel possible
- ◇ = One-coloured model

Pad or silk screen printing on metallic, wooden or laquered rather rubberized surfaces:
 MS = Silk screen on metal
 MT = Pad printing on metal
 P = Special print
 GS = Silk screen on rubberized surfaces
 GT = Pad printing on rubberized surfaces

Notes On The Colour Codes

The complete colour selection of the products has been depicted in the form of inserts. The respective colour codes are comprised in such a way that the last four numbers correspond to the respective PMS colour. Based on the numbers of the Pantone colour palette.

As this is non-binding information, please request the original samples for approval before placing an order.

Important: Please indicate the colour numbers with each order!

Colour code/Refills	
Item No. →	0-0133 (● 8-0855)
	0-0133 SI (● 8-0855)
	50-0002
	50-0001
	↑
	Colour code

NEWS NEWS NEWS
S NEWS NE S NEW





NEWS NEWS **NEWS** NEWS
WS NEWS NEWS NEWS NEWS



RECYCLED PET PEN FUTURE F
0-2217 F
ab Seite/from page 29



RECYCLED PET PEN
CHANGE ocean
0-2248 OCEAN
ab Seite/from page 27



RECYCLED PET PEN
STEP F GUM
0-2210 F GUM
ab Seite/from page 32



RECYCLED PET PEN PRO K
transparent GUM
0-2250 KT GUM
ab Seite/from page 35



TRINITY K transparent RECY
0-0133 KT RECY
ab Seite/from page 67

STRAIGHT GUM RECY
0-9450 GUM RECY
ab Seite/from page 95

LUMOS RECY
0-9560 RECY
ab Seite/from page 97

ROOT
5-5700
ab Seite/from page 83



SKY M GUM
0-0125 M GUM
ab Seite/from page 109

LINEO SI
0-0154 SI
ab Seite/from page 125

FASHION SI
0-0134 SI
ab Seite/from page 163

CHILL C RECY
1-0043 C RECY
ab Seite/from page 76

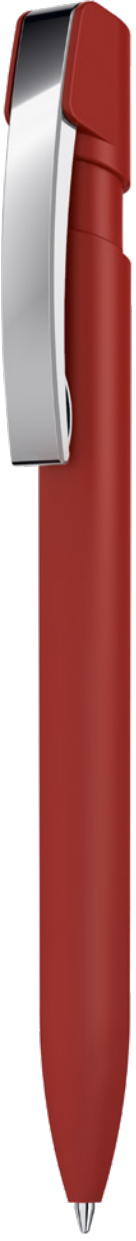

QR-CODE

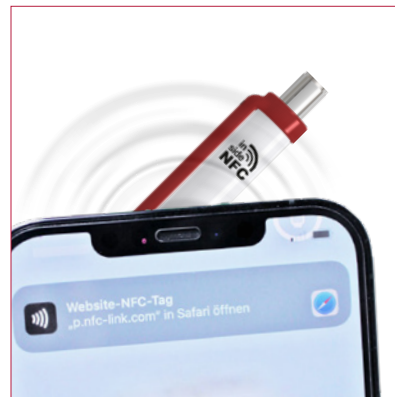

NFC

GROOVE TO RECY
0-9530 TO RECY
ab Seite/from page 99

ELLIPSE SI
0-9540 SI
ab Seite/from page 236

MOOD CARBON
0-9340 C
ab Seite/from page 211

VIP GUM
0-9100 GUM
ab Seite/from page 216





Die Besten noch schneller.

- ▶ 5 Tage Produktionszeit ab Freigabe der Standskizze
- ▶ Bis zu 5-farbig bedruckt (1 Druckstand: Druckarten Siebdruck und Tampondruck sowie Lasergravur)
- ▶ Gütlig für alle Farben der jeweiligen Modellserie
- ▶ 11 Modellserien mit 26 verschiedenen Modellvarianten
- ▶ Kunststoffschreibgeräte, Metallschreibgeräte oder nachhaltige, recycelte PET Schreibgeräte
- ▶ Aufschlag für den umaPRIME Service auf Anfrage



HAPPY
siehe Seite 130
see page 130

TRINITY
siehe Seite 102-103
see page 102-103

ARCTIS
siehe Seite 179
see page 179

UP
siehe Seite 132-133
see page 132-133

YES
siehe Seite 126-129
see page 126-129

SKY
siehe Seite 108-109
see page 108-109

UMA[®] PRIME

The best even faster.

- ▶ 5 days production time starting from the day of the confirmed proof
- ▶ Up to 5-colour printing (1 printing position: screen printing, pad printing and laser engraving)
- ▶ Valid for all colours of the respective model series
- ▶ 11 model series with 26 different model variants
- ▶ Plastic writing utensils, metal writing utensils or sustainable, recycled PET writing utensils
- ▶ Surcharge for the umaPRIME service on request



STRAIGHT
siehe Seite 240
see page 240



GROOVE RECY
siehe Seite 98-99
see page 98-99



LUMOS
siehe Seite 247
see page 247



VIP
siehe Seite 217
see page 217



HAPPY RECY
siehe Seite 68-69
see page 68-69



RECYCLED PET PEN PRO
siehe Seite 36-37
see page 36-37

NATUR NA
NATURAL

R NATU
NATUR





UR **NATUR** NATUR NATUR NATUR NATUR NATUR
AL NATURAL **NATURAL** NATURAL NATURAL NATURAL

Wir übernehmen Verantwortung

Wir von uma stehen für ein verantwortliches Wirtschaften. Das bedeutet, dass bei uns Werte wie Qualität und Kundenzufriedenheit, wie auch die Einhaltung sozialer Verhaltensweisen und Aspekte der Nachhaltigkeit an oberster Stelle stehen. Auch bei unseren Partnern legen wir höchsten Wert auf menschenwürdige und umweltverträgliche Arbeitsbedingungen, wie beispielsweise die Einhaltung von Arbeitnehmerrechten, das Verbot von Kinder- und Zwangsarbeit sowie den verantwortungsbewussten Umgang mit der Natur und ihren Ressourcen.

Für die Einhaltung dieser Ziele stehen wir mit unserem Namen.

Für unsere gesellschaftliche Verantwortung (CSR) wurden wir von EcoVadis mit der Bronzemedaille ausgezeichnet.



We assume responsibility

For a company focused on the future, it almost goes without saying that quality, service and, by extension, customer loyalty, should always be maintained at the highest level. The holistic viewpoint of any successful company must encompass seamless observance of social modes of behaviour in the daily conduct of its business. The scope of our sense of responsibility extends to the assurance of environmentally compliant working conditions that are truly worthy of our payroll staff. That translates into things like respect for employee rights, the prohibition of child labour and forced labour, as well as a responsible attitude towards our natural world and its resources. We put our name on the line when it comes to achievement of these objectives.

EcoVadis rewarded us with a bronze medal for our corporate social responsibility (CSR).

umaSECRETS

In den umaSECRETS erfahren Sie mehr darüber, wie man bei uma Nachhaltigkeit und soziale Verantwortung nicht nur schreibt, sondern auch lebt. Fordern Sie ihre persönliche Broschüre an oder lesen Sie online im Downloadbereich auf uma-pen.com.

umaSECRETS

With our umaSECRETS you can find out how uma puts sustainability and social responsibility into practice. Order your personal brochure now, or download it online at uma-pen.com.



PEFC- und FSC®-Zertifizierung

Als Produzent aus dem Schwarzwald freut es uns, PEFC- und FSC®-zertifizierte Holzschreibgeräte garantieren zu können und somit zum Schutz von nachhaltigen Rohstoffen beizutragen. Für uns ist es eine Selbstverständlichkeit, an diesem Verfahren zur nachhaltigen Waldbewirtschaftung und zum Schutz eines wichtigen Rohstoffes teilzunehmen.

PEFC garantiert, dass Holz- und Papierprodukte aus nachhaltig bewirtschafteten Wäldern stammen. Mit einer Fläche von über 265 Millionen Hektar zertifizierter Waldfläche garantiert PEFC als größtes Waldzertifizierungssystem weltweit ausreichend Rohstoffmengen. Und rund 1,44 Million Hektar Wald sind in Deutschland FSC® zertifiziert. Dank dieser Zertifizierung übernehmen wir bei uma gesellschaftliche Verantwortung, denn wir unterstützen den verantwortungsbewussten Umgang mit Ressourcen und setzen uns somit für den aktiven Beitrag zum Erhalt der Wälder ein.

PEFC and FSC® certification

As producer in the Black Forest we are happy to present and warranty you PEFC- and FSC®-certified pens made of wood and that we have a share in the prevention of enduring raw materials. For uma Schreibgeräte Ullmann GmbH it is self-evident to take part in the sustainable forest cultivation and for the safety of a very important resource.

PEFC guarantees that wood and paper products made from sustainably managed forest. With an area of over 265 million hectare of certified forest area, PEFC guarantees as the largest forest certification system, sufficient quantities of raw materials are available worldwide. And about 1.44 million hectares German forests are FSC® certificated. Thanks to this certification, uma assumes social responsibility, because we support responsible handling resources and are therefore committed to making an active contribution to the preservation of the forests.

Tradition basiert auf ständigen Innovationen

Bei dem Innovationswettbewerb TOP 100 hat uma es nach 2019 und 2022 auch in 2024 wieder unter die Besten geschafft. In einem unabhängigen Auswahlverfahren konnten wir besonders mit innovativen Prozessen und innovativem Management nachhaltig punkten. Dass sich zukunftssträchtiges Agieren auch in innovativen Produkten niederschlägt, konnte mit der uma RECYCLED PET PEN-Serie eindrucksvoll bewiesen werden. Der Einsatz alternativer Materialien und die Investition in neue Produktionsverfahren macht uma zu einem der TOP 100 innovativsten Unternehmen des deutschen Mittelstandes.



Tradition is based on constant innovation

In the TOP 100 innovation competition, uma made it to the top again in 2024 after 2019 and 2022. In an independent selection process, we scored particularly well with innovative processes and innovative management. With the uma RECYCLED PET PEN series, it was impressively demonstrated that future-oriented action is also reflected in innovative products. The use of alternative materials and the investment in new production processes make uma one of the TOP 100 most innovative companies in the German medium-sized sector.

uma Produktion ist ClimatePartner-zertifiziert

Der Klimawandel ist aktuell eine der größten Herausforderungen. Wir wollen Verantwortung übernehmen und leisten einen konkreten Beitrag zum Klimaschutz:

In Zusammenarbeit mit ClimatePartner haben wir die Emissionen von unseren umaNATURALS berechnet und anschließend über regionale Klimaschutzprojekte ausgeglichen.

Wir wären aber nicht uma, wenn wir uns nur auf ein Produkt konzentrieren würden. Aus diesem Grund haben wir die komplette Produktion in Fischerbach, im Herzen des Schwarzwaldes, auf ClimatePartner-zertifiziert gestellt. Wir freuen uns somit einen positiven Beitrag für die Umwelt leisten zu können.



uma production is ClimatePartner-certified

Climate change is currently one of the greatest challenges. We want to assume responsibility and make a concrete contribution to climate protection:

In cooperation with ClimatePartner, we have calculated the emissions of our umaNATURALS then offset them through regional climate protection projects.

But we wouldn't be uma if we only concentrated on one product. For this reason, we have set the complete production in Fischerbach, in the heart of the Black Forest, to ClimatePartner-certified. We are therefore pleased to be able to make a positive contribution to the environment.

uma nachweislich zertifiziert

Die Grundprinzipien unserer Produktionsbedingungen sind klar: Wir sehen es als unternehmerische Verantwortung, menschenwürdige und umweltverträgliche Arbeitsbedingungen sicherzustellen. Somit haben das Einhalten von Arbeitnehmerrechten, sowie der verantwortungsbewusste Umgang mit der Natur und ihren Ressourcen oberste Priorität. Deshalb werden alle uma Produktionsstätten regelmäßig von externen Einrichtungen auditiert und unsere Ansprüche bei persönlichen Besuchen und Briefings den Zulieferern vermittelt. Die Zusammenarbeit mit diesen Produktionsstätten basiert auf jahrelangen und familiären Verbindungen, die ein zusätzliches Sicherheits- und Qualitätsniveau in allen Belangen sicherstellt.

uma demonstrably certified

The basic principles of our production conditions are clear: We see it as our corporate responsibility to ensure humane and environmentally compatible working conditions. Respect for workers' rights and the responsible use of nature and its resources are therefore our top priorities. Therefore, all uma production sites are regularly audited by external institutions and our requirements are communicated to the suppliers during personal visits and briefings. The cooperation with these production sites is based on long-standing and family ties, which ensure an additional level of safety and quality in all matters.



RECYCLED PET PEN CHANGE
0-2248 **new!**

RECYCLED PET PEN CHANGE transparent
0-2248 T **new!**

Farb-Code/Minen
Colour code/Refills



0-2248 (● 8-0854)	0-2248 T (● 8-0854)
57-0298	57-0286
57-0662	57-0185
57-0200	57-0355
57-7492	57-0440
57-0361	57-0291
57-0340	57-0107
57-0002	57-0260
57-7527	57-0226
57-0001	57-0151
57-0012	57-3295
57-0270	UMA Economy Refill 8-0854
57-2607	● 8-0854
57-0233	
57-0021	
57-7710	
57-7500	
UMA Economy Refill 8-0854	
● 8-0854	

Aufgrund der Besonderheiten des Materials (recycliertes PET-Material) sind produktionstechnische Farbschwankungen gegeben.

Due to the special nature of the material (recycled PET material) production-related variations are possible.

Das aus recycelten PET-Flaschen in Europa hergestellte rPET-Material eignet sich für einen langlebigen und nachhaltigen Werbeinsatz. Dank der europäischen und ClimatePartner-zertifizierten Produktion leistet der uma RECYCLED PET PEN CHANGE einen zusätzlichen nachhaltigen Beitrag zur Schonung der Umwelt.

The rPET material, which is produced in Europe from recycled PET bottles, is suitable for a durable and sustainable advertisement. Thanks to the European and ClimatePartner-certified production, the uma RECYCLED PET PEN CHANGE makes an additional sustainable contribution to the protection of the environment.



0-2248: Drehkugelschreiber aus recyceltem PET-Material mit gedeckt glänzendem Gehäuse.

0-2248: Twist ballpoint pen made from recycled PET material with opaque glossy housing.

0-2248 T: Drehkugelschreiber aus recyceltem PET-Material mit transparent glänzendem Gehäuse.

0-2248 T: Twist ballpoint pen made from recycled PET material with transparent glossy housing.

Werbeschlüssel Schaft S, Clip T/HD/RD

Advertising code barrel S, clip T/HD/RD

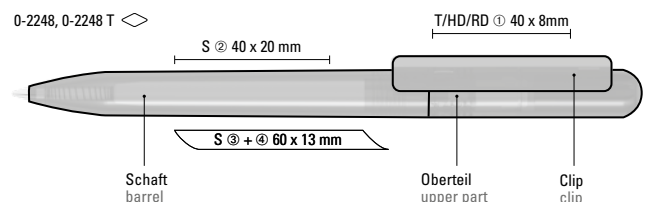

0-2248 OCEAN (● 8-0854)

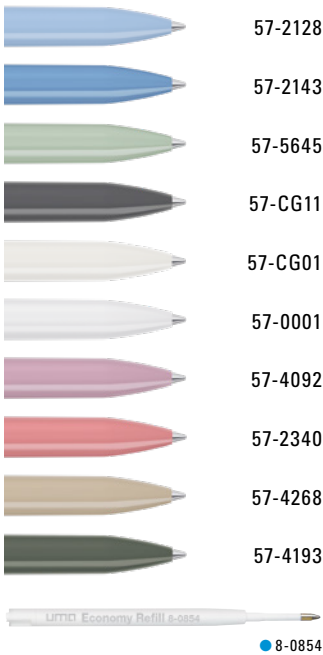

Köcher Empfehlung / Cup suggestion
RECYCLED PET BOX 0-2225
Beschreibung auf Seite 283
See description on page 283



Aufgrund der Besonderheiten des Materials (recyceltes PET-Material) sind produktionstechnische Farbschwankungen gegeben.

Due to the special nature of the material (recycled PET material) production-related variations are possible.

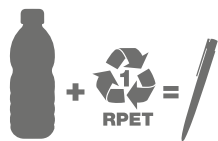

made from ocean-bound plastic

Das durch Plastic Bank gesammelte Ocean Bound Plastic, auch bekannt als Social Plastic®, wird in Europa zu einem recycelten PET Schreibgerät für einen langlebigen und nachhaltigen Werbeeinsatz upgecycelt. Dank der europäischen und ClimatePartner-zertifizierten Produktion leistet der uma RECYCLED PET PEN CHANGE ocean einen zusätzlichen nachhaltigen Beitrag zur Schonung der Umwelt.

Ocean-bound plastic, also known as Social Plastic®, collected through Plastic Bank is upcycled in Europe into a recycled PET writing instrument for long-lasting and sustainable advertisement. Thanks to the European and ClimatePartner-certified production, the uma RECYCLED PET PEN CHANGE ocean makes an additional sustainable contribution to the protection of the environment.

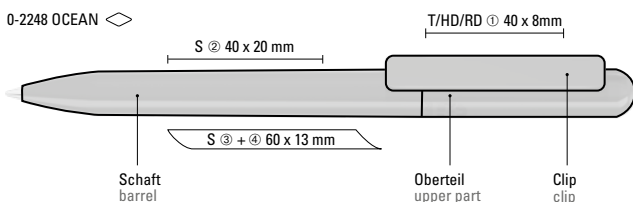

0-2248 OCEAN: Drehkugelschreiber aus recyceltem PET-Material aus Ocean Bound Plastic mit gedeckt glänzendem Gehäuse.

0-2248 OCEAN: Twist ballpoint pen made from ocean bound PET material with opaque glossy housing.

Werbeschlüssel Schaft S, Clip T/HD/RD

Advertising code barrel S, clip T/HD/RD

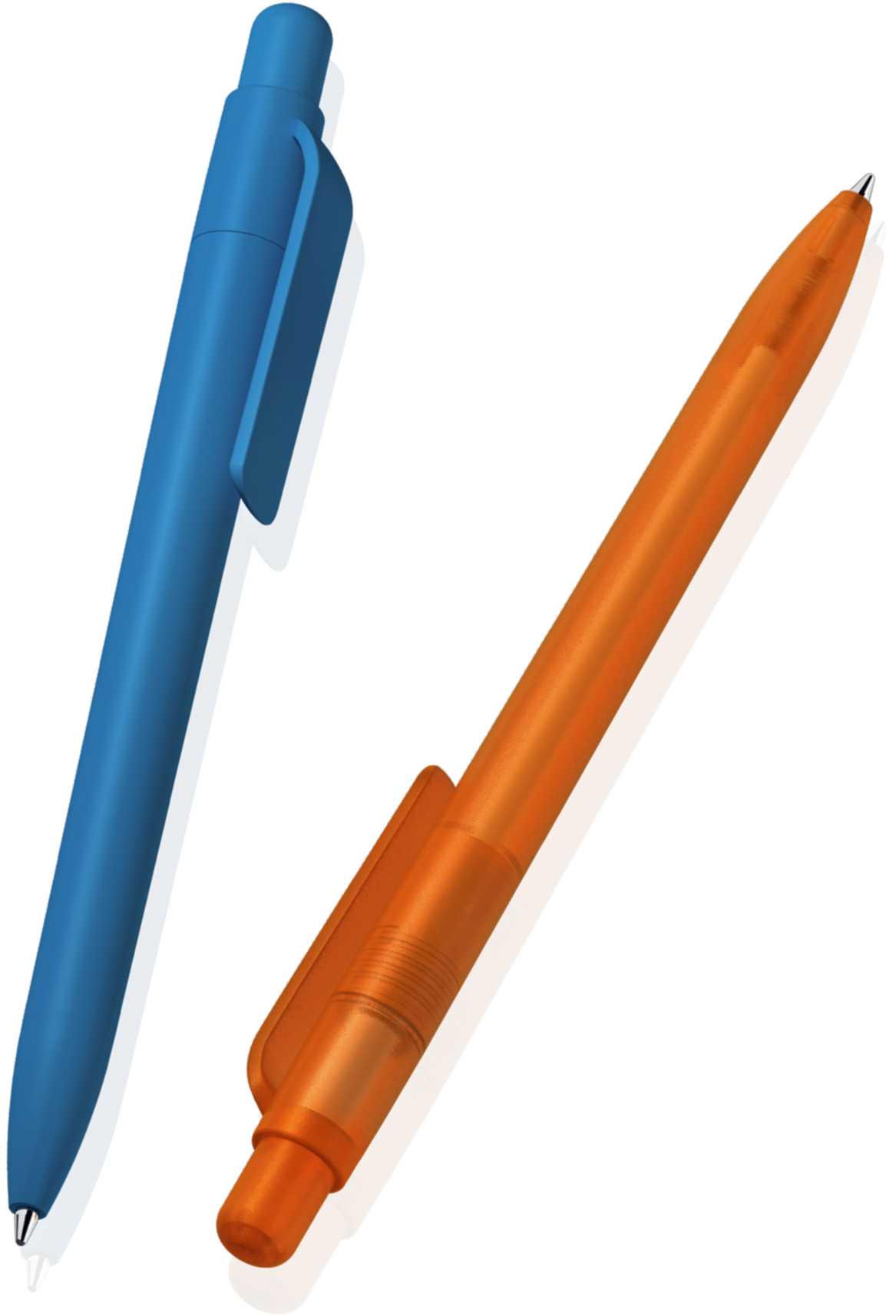



Aufgrund der Besonderheiten des Materials (recyceltes PET-Material) sind produktionstechnische Farbschwankungen gegeben.

Due to the special nature of the material (recycled PET material) production-related variations are possible.



Das in Europa hergestellte rPET-Material eignet sich für einen langlebigen und nachhaltigen Werbeeinsatz. Dank der europäischen und ClimatePartner-zertifizierten Produktion leistet der uma RECYCLED PET PEN FUTURE einen zusätzlichen nachhaltigen Beitrag zur Schonung der Umwelt.

The rPET material, which is produced in Europe, is suitable for a durable and sustainable advertisement. Thanks to the European and ClimatePartner-certified production, the uma RECYCLED PET PEN FUTURE makes an additional sustainable contribution to the protection of the environment.

0-2217 F, 0-2217 TF ◊

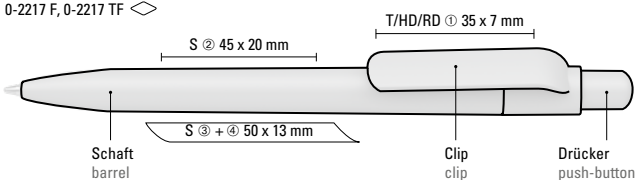

0-2217 F: Druckkugelschreiber aus recyceltem PET-Material mit matt gedecktem Schaft, Clip, Drücker und Stopfen.

0-2217 F: Retractable ballpoint pen made from recycled PET material with opaque matt housing, clip, push-button and plug.

0-2217 TF: Druckkugelschreiber aus recyceltem PET-Material mit gefrostetem Schaft, Clip, Drücker und Stopfen.

0-2217 TF: Retractable ballpoint pen made from recycled PET material with transparent frosted housing, clip, push-button and plug.

Werbeschlüssel Schaft S, Clip T/HD/RD

Advertising code barrel S, clip T/HD/RD



0-2217 F GUM (● 8-0866)



Köcher Empfehlung /
Cup suggestion
RECYCLED PET BOX 0-2225
Beschreibung auf Seite 283
See description on page 283



Aufgrund der Besonderheiten des Materials (recyceltes PET-Material) sind produktionstechnische Farbschwankungen gegeben.

Due to the special nature of the material (recycled PET material) production-related variations are possible.



Das in Europa hergestellte rPET-Material eignet sich für einen langlebigen und nachhaltigen Werbeeinsatz. Dank der europäischen und ClimatePartner-zertifizierten Produktion leistet der uma RECYCLED PET PEN FUTURE F GUM einen zusätzlichen nachhaltigen Beitrag zur Schonung der Umwelt.

The rPET material, which is produced in Europe, is suitable for a durable and sustainable advertisement. Thanks to the European and ClimatePartner-certified production, the uma RECYCLED PET PEN FUTURE F GUM makes an additional sustainable contribution to the protection of the environment.

0-2217 F GUM ◊

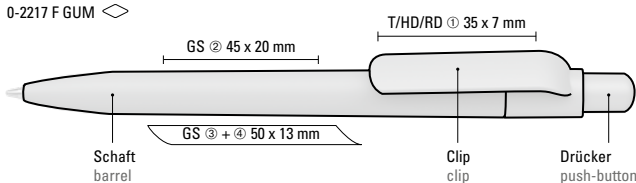

0-2217 F GUM: Druckkugelschreiber aus recyceltem PET-Material mit Softtouch-Schaft und gedeckt mattem Clip, Drücker und Stopfen.

Werbeschlüssel

Schaft GS,
Clip T/HD/RD

0-2217 F GUM: Retractable ballpoint pen made from recycled PET material with softtouch housing and opaque matt clip, push-button and plug.

Advertising code

barrel GS,
clip T/HD/RD



0-2210 F GUM (● 8-0854)

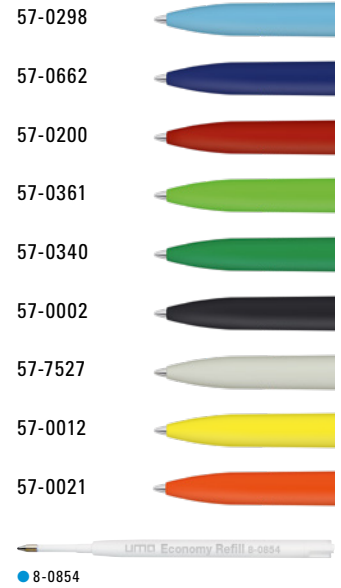

Aufgrund der Besonderheiten des Materials (recyceltes PET-Material) sind produktionstechnische Farbschwankungen gegeben.

Due to the special nature of the material (recycled PET material) production-related variations are possible.



Etui Empfehlung/Case suggestion
ETUI 0-0940 CI rPET

Das aus recycelten PET-Flaschen in Europa hergestellte rPET-Material eignet sich für einen langlebigen und nachhaltigen Werbeinsatz. Dank der europäischen und ClimatePartner-zertifizierten Produktion leistet der uma RECYCLED PET PEN STEP F GUM einen zusätzlichen nachhaltigen Beitrag zur Schonung der Umwelt.

Mix n' Match: Ab 2.000 Stück kann das Modell farblich kombiniert werden.

0-2210 F GUM: Druckkugelschreiber mit gummiertem Gehäuse aus recyceltem PET-Material mit matt gedecktem Clip und Drücker.

Werbeschlüssel

Schaft GS, Clip T

The rPET material, which is produced in Europe from recycled PET bottles, is suitable for a durable and sustainable advertisement. Thanks to the European and ClimatePartner-certified production, the uma RECYCLED PET PEN STEP F GUM makes an additional sustainable contribution to the protection of the environment.

Mix n' Match: From 2,000 pieces, you can choose any colour combination.

0-2210 F GUM: Retractable ballpoint pen with softtouch housing made from recycled PET material with opaque matt clip and push-button.

Advertising code

barrel GS, clip T



ClimatePartner
zertifiziertes Produkt
climate-id.com/DIPVA4



0-2210 F GUM ◀

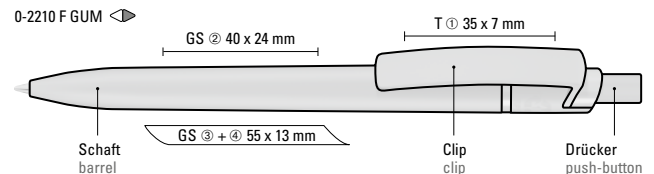

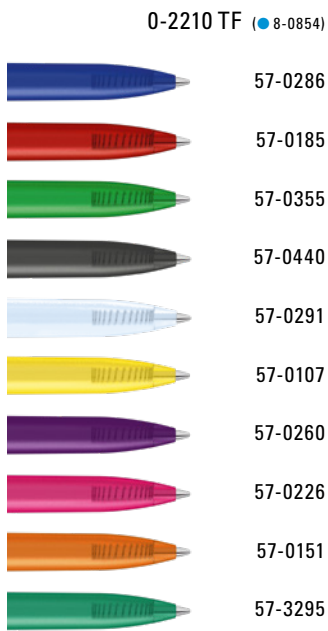
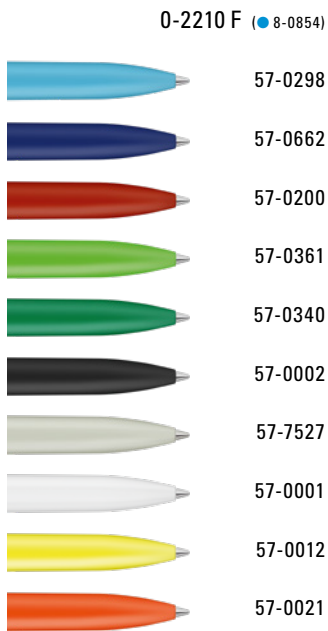

Das aus recycelten PET-Flaschen in Europa hergestellte rPET-Material eignet sich für einen langlebigen und nachhaltigen Werbeeinsatz. Dank der europäischen und ClimatePartner-zertifizierten Produktion leistet der uma RECYCLED PET PEN STEP einen zusätzlichen nachhaltigen Beitrag zur Schonung der Umwelt.

The rPET material, which is produced in Europe from recycled PET bottles, is suitable for a durable and sustainable advertisement. Thanks to the European and ClimatePartner-certified production, the uma RECYCLED PET PEN STEP makes an additional sustainable contribution to the protection of the environment.

Mix n' Match: Ab 2.000 Stück kann das Modell farblich kombiniert werden.
0-2210 F: Druckkugelschreiber aus recyceltem PET-Material mit matt gedecktem Gehäuse, Clip und Drücker.
0-2210 TF: Druckkugelschreiber aus recyceltem PET-Material mit transparent gefrostetem Gehäuse, Clip und Drücker.
Werbeschlüssel

Mix n' Match: From 2,000 pieces, you can choose any colour combination.
0-2210 F: Retractable ballpoint pen made from recycled PET material with opaque matt housing, clip and push-button.
0-2210 TF: Retractable ballpoint pen made from recycled PET material with transparent frosted housing, clip and push-button.
Advertising code

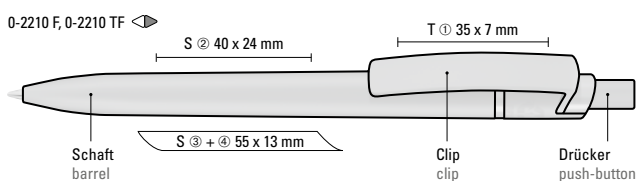

Schaft S, Clip T

barrel S, clip T



0-2250 KT GUM (● 8-0854)



Aufgrund der Besonderheiten des Materials (recyceltes PET-Material) sind produktionstechnische Farbschwankungen gegeben.

Due to the special nature of the material (recycled PET material) production-related variations are possible.



Das aus recycelten PET-Flaschen in Europa hergestellte rPET-Material eignet sich für einen langlebigen und nachhaltigen Werbeeinsatz. Dank der europäischen und ClimatePartner-zertifizierten Produktion leistet der uma RECYCLED PET PEN PRO K transparent GUM einen zusätzlichen nachhaltigen Beitrag zur Schonung der Umwelt.

The rPET material, which is produced in Europe from recycled PET bottles, is suitable for a durable and sustainable advertisement. Thanks to the European and ClimatePartner-certified production, the uma RECYCLED PET PEN PRO K transparent GUM makes an additional sustainable contribution to the protection of the environment.

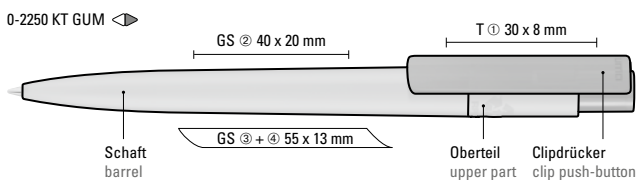

Mix n' Match: Ab 2.000 Stück kann das Modell farblich kombiniert werden.

0-2250 KT GUM: Druckkugelschreiber mit gummiertem Gehäuse aus recyceltem PET-Material mit transparent glänzendem Clip.

Werbeschlüssel

Schaft GS, Clip T

Mix n' Match: From 2,000 pieces, you can choose any colour combination.

0-2250 KT GUM: Retractable ballpoint pen with softtouch housing made from recycled PET material with transparent clip.

Advertising code

barrel GS, clip T

RECYCLED PET PEN PRO
0-2250

RECYCLED PET PEN PRO F
0-2250 F

Farb-Code/Minen
Colour code/Refills

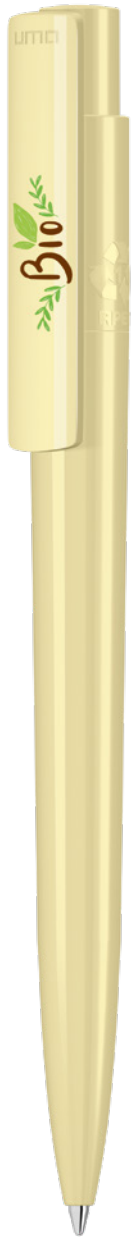

UMA[®]
PRIME



0-2250 (● 8-0854)
0-2250 F (● 8-0854)

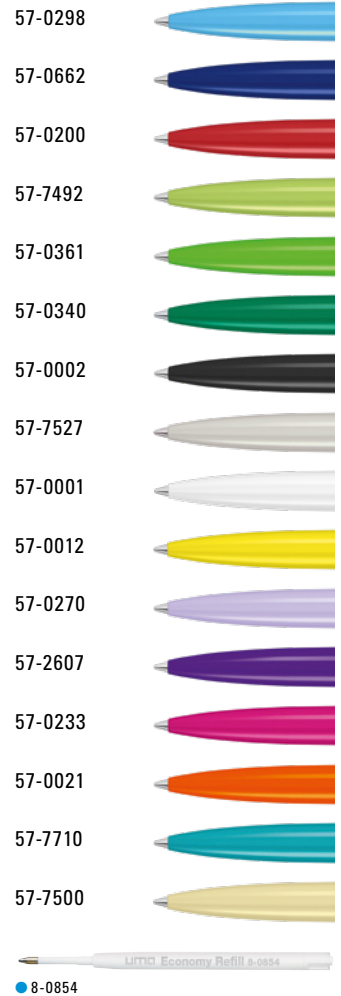

Aufgrund der Besonderheiten des Materials (recyceltes PET-Material) sind produktionstechnische Farbschwankungen gegeben.

Due to the special nature of the material (recycled PET material) production-related variations are possible.

Das aus recycelten PET-Flaschen in Europa hergestellte rPET-Material eignet sich für einen langlebigen und nachhaltigen Werbeinsatz. Dank der europäischen und ClimatePartner-zertifizierten Produktion leistet der uma RECYCLED PET PEN PRO einen zusätzlichen nachhaltigen Beitrag zur Schonung der Umwelt.

Mix n' Match: Ab 2.000 Stück kann das Modell farblich kombiniert werden.

0-2250: Druckkugelschreiber aus recyceltem PET-Material mit gedecktem glänzendem Gehäuse und Clip.

0-2250 F: Druckkugelschreiber aus recyceltem PET-Material mit gedecktem Gehäuse und Clip.

Werbeschlüssel

Schaft S, Clip T

The rPET material, which is produced in Europe from recycled PET bottles, is suitable for a durable and sustainable advertisement. Thanks to the European and ClimatePartner-certified production, the uma RECYCLED PET PEN PRO makes an additional sustainable contribution to the protection of the environment.

Mix n' Match: From 2,000 pieces, you can choose any colour combination.

0-2250: Retractable ballpoint pen made from recycled PET material with opaque glossy housing and clip.

0-2250 F: Retractable ballpoint pen made from recycled PET material with opaque matt housing and clip.

Advertising code

barrel S, clip T



ClimatePartner
zertifiziertes Produkt
climate-id.com/DIPVA4



0-2250, 0-2250 F ◀

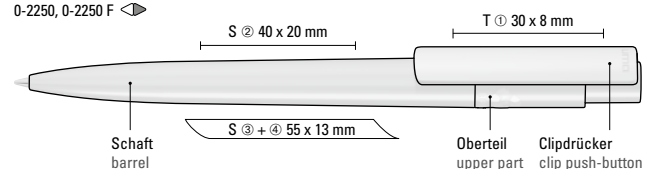

0-2250 T (● 8-0854)
0-2250 TF (● 8-0854)



Etui Empfehlung/Case suggestion
ETUI 0-0955 rPET
Beschreibung auf Seite 284
See description on page 284



UMA
PRIME



ClimatePartner
zertifiziertes Produkt
climate-id.com/DIPVA4



Das aus recycelten PET-Flaschen in Europa hergestellte rPET-Material eignet sich für einen langlebigen und nachhaltigen Werbeeinsatz. Dank der europäischen und ClimatePartner-zertifizierten Produktion leistet der uma RECYCLED PET PEN PRO einen zusätzlichen nachhaltigen Beitrag zur Schonung der Umwelt.

The rPET material, which is produced in Europe from recycled PET bottles, is suitable for a durable and sustainable advertisement. Thanks to the European and ClimatePartner-certified production, the uma RECYCLED PET PEN PRO makes an additional sustainable contribution to the protection of the environment.

Mix n' Match: Ab 2.000 Stück kann das Modell farblich kombiniert werden.

Mix n' Match: From 2,000 pieces, you can choose any colour combination.

0-2250 T: Druckkugelschreiber aus recyceltem PET-Material mit transparent glänzendem Gehäuse und Clip.

0-2250 T: Retractable ballpoint pen made from recycled PET material with transparent glossy housing and clip.

0-2250 TF: Druckkugelschreiber aus recyceltem PET-Material mit transparent gefrostetem Gehäuse und Clip.

0-2250 TF: Retractable ballpoint pen made from recycled PET material with transparent frosted housing and clip.

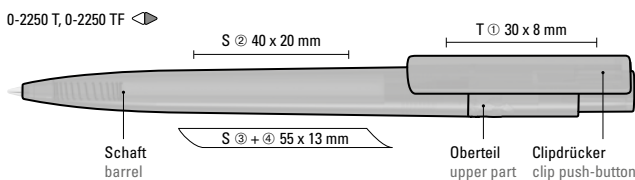

Werbeschlüssel

Schaft S, Clip T

Advertising code

barrel S, clip T

Wie schreibt man „nachhaltig“?

Nachhaltigkeit – ein Thema, das uma schon seit vielen Jahren bewegt, dies spiegelt sich nicht nur in unserer generationsübergreifenden und zukunftsorientierten Firmengeschichte wider, sondern auch in den innovativen uma Produktideen. Mit den uma RECYCLED PET PEN-Serien haben wir die erste tatsächlich nachhaltige Schreibgeräte-Serie entwickelt, die nicht nur in Haptik und Variationsmöglichkeit, sondern auch mit einer innovativen Recyclingidee überzeugt.



How do you write 'sustainable'?

Sustainability – a topic that has been on uma's agenda for many years. This is reflected not only in our generation-spanning and future-oriented company history, but also in the innovative uma product ideas. With the uma RECYCLED PET PEN series we have developed the first truly sustainable writing instrument series, which not only convinces in haptics and variation possibilities, but also with an innovative recycling idea.



Die uma RECYCLED PET PEN-Serie

Schreiben Sie mit der ersten in Europa gefertigten, komplett ClimatePartner-zertifizierten, recycelten, nachhaltigen Schreibgeräte-Serie. Die uma RECYCLED PET PEN-Serie.

Mit Innovationen Werben

Die verschiedenen Schreibsysteme, neben dem klassischen Kugelschreiber, basieren alle auf einem eigens entwickelten und innovativen Tintenleitsystem. Die Patronen können in allen Schreibgeräten ausgewechselt und nachgerüstet werden. Langlebiges Schreiben und Werben ist somit garantiert. Die Kombination aus Schreibsystemen und recyceltem PET-Material macht die uma RECYCLED PET PEN-Serie zu einer Weltneuheit. Die erste nachhaltige Schreibgeräte-Serie aus recyceltem PET-Material, die ClimatePartner-zertifiziert produziert wird, verleiht den werbenden Unternehmen in der Kommunikation nicht nur Nachhaltigkeit, sondern auch geschriebene Innovation. Die nachhaltige Schreibgeräte-Familie, uma RECYCLED PET PEN verspricht Werbekommunikation und Schreibvergnügen auf höchstem Niveau.

The uma RECYCLED PET PEN series

Write with the first European, ClimatePartner-certified, recycled and sustainable produced writing instrument series. The uma RECYCLED PEN PEN series.

Advertising with innovations

Along with the classic ballpoint pen, the various writing systems are all based on a specially developed and innovative ink flow system. The cartridges can be used and retrofitted. This guarantees long-lasting writing joy and appeal. The combination of writing systems and recycled PET material makes the uma RECYCLED PET PEN series a world first. The first sustainable writing series made from recycled PET material, which is produced ClimatePartner-certified, gives companies looking to communicate attractively sustainable and written innovation. The sustainable uma RECYCLED PET PEN series guarantees promotional communication and an enjoyable writing experience of the highest quality.



Schreiben auch Sie Verantwortung! / Communicate your responsibility too!

Schreiben Sie die uma RECYCLED PET PEN-Serie mit folgenden Pro-Argumenten

Communicate the uma RECYCLED PET PEN series with the following pro arguments

 <ul style="list-style-type: none"> • Weltneuheit: Erste in Europa gefertigte, recycelte, ClimatePartner-zertifizierte Schreibgeräte-Serie aus rPET-Material. • Ein Recyclingprozess wurde bereits durchlaufen. • World first: First recycled, ClimatePartner-certified writing series produced from rPET material and made in Europe. • One recycling process has already been completed. 	 <ul style="list-style-type: none"> • rPET-Material zu 100 % aus recycelten PET-Flaschen. • Eine 0,5 l PET-Flasche ergibt genau ein Schreibgerätegehäuse. • Langlebiges, nachhaltiges Material – eignet sich zum Upcycling. • rPET material made 100 % from recycled PET bottles. • One 0,5 l PET bottle produces exactly one housing of a pen. • Long-lasting, sustainable material – suitable for upcycling.
 <ul style="list-style-type: none"> • Es werden ausschließlich PET-Flaschen aus Europa verwendet (außer Ocean Bound Plastic). • Made in Europe. • Only PET bottles from Europe are used (except ocean-bound plastic). • Made in Europe. 	 <ul style="list-style-type: none"> • Optimaler CO₂-Fußabdruck. • ClimatePartner-zertifizierte Produktion und Veredelung. • Low carbon footprint. • ClimatePartner-certified production and processing.
 <ul style="list-style-type: none"> • Alle Schreibgeräte sind mit dem international bekannten „rPET RECY-Zeichen“ versehen. • Kann einem weiteren Recyclingprozess zugeführt werden. • All stationery features the internationally recognised “rPET RECY logo”. • Can be recycled further. 	  <ul style="list-style-type: none"> • Designs auch als antimikrobielle Variante erhältlich, zertifiziert nach ISO 22196-2011. • #gesundbleiPEN – Hygiene und Nachhaltigkeitskonzept werden mit einem Schreibgerät erfüllt. • Designs also available as antimicrobial version, certified according to ISO 22196-2011. • #antibacterial – hygiene and sustainability concept are fulfilled with one writing instrument.



- Einzigartige Gehäusefarbpalette, zusätzliche Einfärbung nach PMS und Mix & Match-Service.
- Unique housing colour range, additional colouring based on PMS and Mix & Match service.



Vier Schreibsysteme ein Design

- **Kugelschreiber** mit Dokumental® Schreibpaste ●●●
- **Rollerball** ●●●●●●●●●●
- **Highlighter** mit Dokumental® Highlighterpaste, EN-71-3, ASTM D4326 ●●●●●●●●
- **Fineliner** mit Dokumental® Finelinerpaste, EN-71-3, ASTM D4326 ●●●●●●●●●●

Four writing systems one design

- **Ballpoint pen** with Dokumental® writing ink ●●●
- **Rollerball** ●●●●●●●●●●
- **Highlighter** with Dokumental® highlighter ink, EN-71-3, ASTM D4326 ●●●●●●●●
- **Fineliner** with Dokumental® finelinerpaste, EN-71-3, ASTM D4326 ●●●●●●●●●●



- Geschlossener und kontrollierter Recycling- bzw. Produktionsprozess nach dem „Global Recycling Standard“ zertifiziert.
- Zertifizierte und ausgezeichnete Idee.
- Closed and controlled recycling and production process certified based on the “Global Recycling Standard”.
- Certified and award-winning concept.



Nachhaltigkeit kombiniert mit innovativer Schreibtechnologie – Das uma Tintenleitsystem

Dank der innovativen Weiterentwicklung der uma RECYCLED PET PEN PRO-Serie ergeben sich zusätzliche Varianten von Schreibsystemen und Werbeoptionen für den Kunden.

Neben dem klassischen Kugelschreiber können weitere Schreibsysteme im identischen Design, aus recyceltem PET-Material mit den gleichen Nachhaltigkeitsvorteilen umgesetzt werden.

Sustainability combined with innovative writing technology – The uma ink flow system

Thanks to the innovative further development of the uma RECYCLED PET PEN PRO series, additional types of writing system and promotional options have been created for customers.

Along with the classic ballpoint pen, other identical writing systems made from recycled PET material can be used with the same sustainability benefits.



So schreiben Sie ab sofort Nachhaltigkeit auch mit dem uma Highlighter:

RECYCLED PET PEN PRO LIQEO

Textmarker sind aus dem täglichen Bürobedarf nicht mehr wegzudenken. Somit sind die Highlighter in 6 Schreibfarben sowohl für den internen Gebrauch, aber auch für die Abgabe als Werbe- und Kommunikationstool perfekt. Auch im Bereich Schule, Ausbildungsmessen oder Mitarbeiterrekrutierung können diese Modelle optimal eingesetzt werden.

Now you can write sustainably with the uma highlighter:

RECYCLED PET PEN PRO LIQEO

Highlighters are an essential office item. Thus, the highlighters in 6 writing colours are suitable for office use and as an advertising and communication tool. These models can be optimally used in schools, at training fairs or employee recruitment.



RECYCLING PET PEN PRO LIQEO

0-2255

Seite/page 43

Spüren Sie nachhaltigen Schreibgenuss auch mit dem uma Rollerball:

RECYCLED PET PEN PRO Rollerball

Ein Rollerball für den besonders feinen Strich. In der uma RECYCLED PET PEN PRO-Serie gleich in 8 Schreibfarben erhältlich. Unterschriften für Verträge oder für ein einfach schönes Schreibgefühl ergeben weitere Werbeeinsatzmöglichkeiten.

Experience the enjoyment of sustainable writing with the uma rollerball:

RECYCLED PET PEN PRO Rollerball

A rollerball for a particularly fine line. Available in 8 writing colours in the uma RECYCLED PET PEN PRO series. Signing contracts or for a simply exquisite writing experience result in additional promotional opportunities.



RECYCLING PET PEN PRO Roller
0-2252 R
Seite/page 42

Bringen Sie zukunftsorientierte Entwicklungen auf den Punkt mit dem uma Fineliner:

RECYCLED PET PEN PRO Fineliner

Unterstreichen, hervorheben oder technisches Zeichnen, mit einem Fineliner kann der dünne Strich nicht nur präzise, sondern auch in Farbe umgesetzt werden. In der uma RECYCLED PET PEN PRO-Serie geht das mit 12 Standardfarben.

Get to the heart of future-oriented developments with the uma fineliner:

RECYCLED PET PEN PRO Fineliner

Emphasise, highlight or technical drawing – the thin streak of a fineliner can be precisely presented in colour format. 12 standard colours are available in the uma RECYCLED PET PEN PRO series.



RECYCLING PET PEN PRO Fineliner
0-2254 FL
Seite/page 42

RECYCLED PET PEN PRO R
0-2252 R

RECYCLED PET PEN PRO FL
0-2254 FL

Farb-Code/Minen
Colour code/Refills

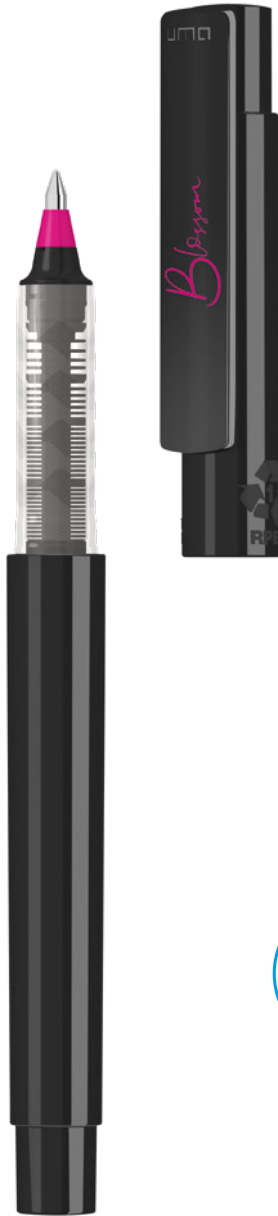

0-2252 R



0-2254 FL



Das aus recycelten PET-Flaschen in Europa hergestellte rPET-Material eignet sich für einen langlebigen und nachhaltigen Werbeeinsatz. Dank der europäischen und ClimatePartner-zertifizierten Produktion leistet der uma RECYCLED PET PEN PRO einen zusätzlichen nachhaltigen Beitrag zur Schonung der Umwelt.

The rPET material, which is produced in Europe from recycled PET bottles, is suitable for a durable and sustainable advertisement. Thanks to the European and ClimatePartner-certified production, the uma RECYCLED PET PEN PRO makes an additional sustainable contribution to the protection of the environment.

0-2252 R: Rollerball mit Gehäuse aus recyceltem PET-Material in gedeckt glänzend weiß oder schwarz. Stopfen in den 8 möglichen Schreibfarben.

0-2252 R: Rollerball with opaque glossy housing in white or black made from recycled PET material. Plug in 8 possible writing colours.

0-2254 FL: Fineliner mit Gehäuse aus recyceltem PET-Material in gedeckt glänzend weiß oder schwarz. Stopfen in den 12 möglichen Schreibfarben.

0-2254 FL: Fineliner with opaque glossy housing in white or black made from recycled PET material. Plug in 12 possible writing colours.

Werbeschlüssel Schaft S, Clip T,
Kappe T

Advertising code barrel S, clip T,
cap T

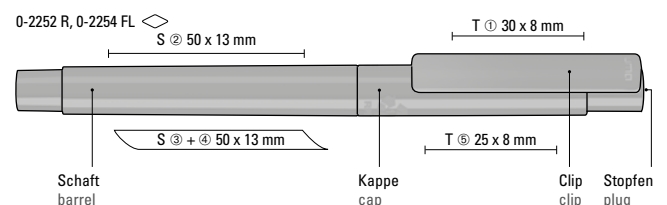

0-2252 R

57-0002



57-0001

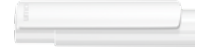

Tintenleitsystem/ink flow system

57-0298



57-0662



57-0200



57-0361



57-0002



57-2607



57-0233



57-0021



0-2254 FL

57-0002



57-0001

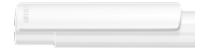

Tintenleitsystem/ink flow system

57-0298



57-0662



57-0200



57-7492



57-0361



57-0002



57-7527



57-0012



57-2607



57-0233









57-0021

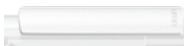
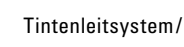

57-0478



	0-2255
	57-0002
	57-0001
Tintenleitsystem/ink flow system	
	57-0801
	57-0802
	57-0930
	57-0814
	57-0806
	57-0804



0-2255
●●●●●

Aufgrund der Besonderheiten des Materials (recyceltes PET-Material) sind produktionstechnische Farbschwankungen gegeben.

Due to the special nature of the material (recycled PET material) production-related variations are possible.

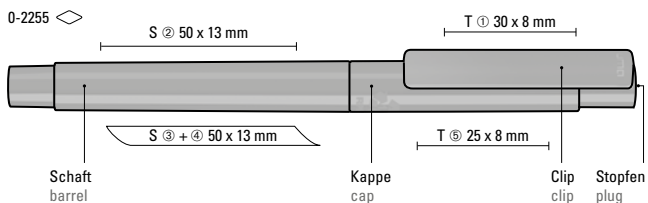

Das aus recycelten PET-Flaschen in Europa hergestellte rPET-Material eignet sich für einen langlebigen und nachhaltigen Werbeeinsatz. Dank der europäischen und ClimatePartner-zertifizierten Produktion leistet der uma RECYCLED PET PEN PRO einen zusätzlichen nachhaltigen Beitrag zur Schonung der Umwelt.

0-2255: Flüssig-Textmarker mit Gehäuse aus recyceltem PET-Material in gedeckt glänzend weiß oder schwarz. Stopfen in den 6 möglichen Schreibfarben. Der Highlighter ist ohne Pumpen oder Anstechen sofort einsatzfähig. Neues Flüssigtintenleitsystem – Bessere Schreibqualität – Höhere Leuchtkraft – Längere Schreibdauer – Umweltfreundlicher – Produziert nach EN-71, ASTM D-4236, Flüssigtank austausch- bzw. nachfüllbar.

The rPET material, which is produced in Europe from recycled PET bottles, is suitable for a durable and sustainable advertisement. Thanks to the European and ClimatePartner-certified production, the uma RECYCLED PET PEN PRO makes an additional sustainable contribution to the protection of the environment.

0-2255: Liquid highlighter with opaque glossy housing in white or black made from recycled PET material. Plug in 6 possible writing colours. Writes longer and more intensive as conventional highlighter, is without pumping or tapping operational immediately, supported in this way the sustainability concept. New liquid ink delivery system – better writing quality – greater luminance – longer writing time – ecologically superior – produced in acc. with EN-71, ASTM D-4236, liquid tank replaceable or refillable.

Werbeschlüssel

Schaft S, Clip T, Kappe T

Advertising code

barrel S, clip T, cap T

RECYCLED PET PEN PRO SI

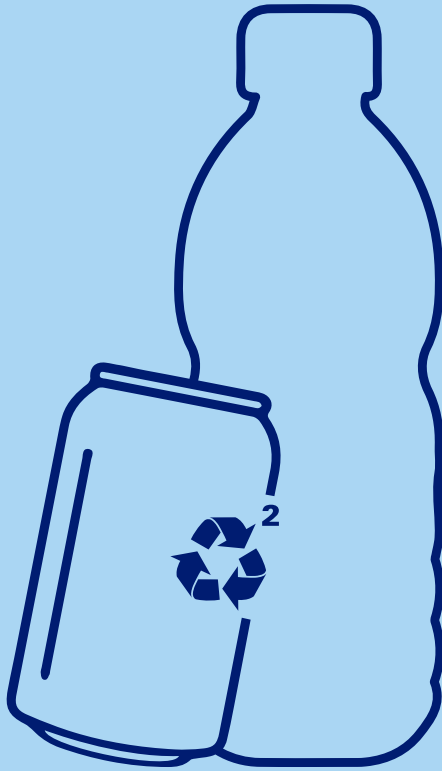

sustainable
RECYCLED²
INNOVATIVE

RECYCLED PET PEN PRO SI Recycled² – die nachhaltigste Kombination in einem Schreibgerät!

Recycelte PET-Getränke-Flaschen treffen auf recycelte Aluminium Getränkedosen. Die uma rPET PRO Serie ist eine der nachhaltigsten Schreibgeräteentwicklungen der Werbebranche. Eine ClimatePartner-zertifizierte, europäische und nach Global Recycled Standard zertifizierte Produktion bilden die Basis für langlebiges und nachhaltiges Schreiben. Die neue Upcycling-Idee erweitert die bisher reine recycelte PET-Schreibgeräteserie um schicke Metallapplikationen. Aus einer recycelten Aluminium 150 ml Getränkedose entstehen 10 wertige Metallspitzen, die auf ein PET-Gehäuse einer recycelten 0,5 l PET-Flasche treffen. So schreiben Sie mit dem uma RECYCLED PET PEN PRO SI die nachhaltigste Kombination für die Umwelt – eben: uma Recycled².

RECYCLED PET PEN PRO SI Recycled² – the most sustainable combination in a writing instrument!

Recycled PET beverage bottles meet recycled aluminium beverage cans. The uma rPET PRO series is one of the most sustainable writing instrument developments in the promotional industry. A ClimatePartner-certified, European and Global Recycled Standard certified production built up the basics for long-lasting and sustainable writing. The new upcycling idea adds elegant metal applications to the previously pure recycled PET writing instrument series. A recycled aluminium 150ml beverage can is recycled into 10 valuable metal tips that meet a PET housing of a recycled 0.5 l PET bottle. So with the uma RECYCLED PET PEN PRO SI you write the most sustainable combination for the environment – just: uma Recycled².



Produkt-Video/product video
RECYCLED PET PEN PRO SI

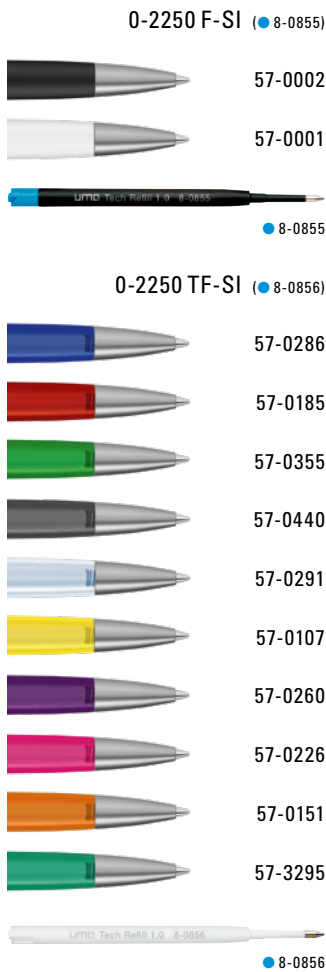

Aufgrund der Besonderheiten des Materials (recyceltes PET-Material) sind produktionstechnische Farbschwankungen gegeben.

Due to the special nature of the material (recycled PET material) production-related variations are possible.



Die Gewinnung und Verarbeitung des rPET-Materials aus 100% recycelten PET-Flaschen sowie das rAL-Material aus 100% recycelten Aluminium-Getränkedosen findet in Europa statt. Die beiden Materialien eignen sich für einen langlebigen und nachhaltigen Werbeinsatz. Dank der europäischen und ClimatePartner-zertifizierten Produktion leistet der uma RECYCLED PET PEN PRO einen zusätzlichen nachhaltigen Beitrag zur Schonung der Umwelt.

The extraction and processing of the rPET material from 100% recycled PET bottles, as well as the rAL material from 100% recycled aluminium beverage cans takes place in Europe. Both materials are suitable for a durable and sustainable advertisement. Thanks to the European and ClimatePartner-certified production, the uma RECYCLED PET PEN PRO makes an additional sustainable contribution to the protection of the environment.

Mix n' Match: Ab 2.000 Stück kann das Modell farblich kombiniert werden.

Mix n' Match: From 2,000 pieces, you can choose any colour combination.

0-2250 F-SI: Druckkugelschreiber aus recyceltem PET-Material mit matt gedecktem Gehäuse und Clip sowie Metallspitze aus recyceltem Aluminium in silber matt.

0-2250 F-SI: Retractable ballpoint pen made from recycled PET material with opaque matt housing and clip, metal tip made from recycled aluminium in matt silver.

0-2250 TF-SI: Druckkugelschreiber aus recyceltem PET-Material mit transparent gefrostetem Gehäuse und Clip sowie Metallspitze aus recyceltem Aluminium in silber matt.

0-2250 TF-SI: Retractable ballpoint pen made from recycled PET material with transparent frosted housing and clip, metal tip made from recycled aluminium in matt silver.

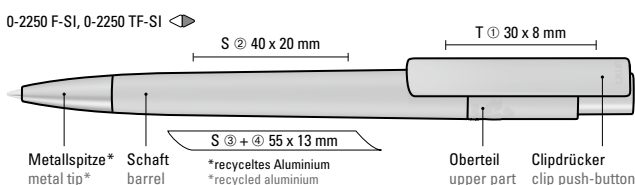

Werbeschlüssel

Schaft S, Clip T

Advertising code

barrel S, clip T



0-2250 F-SI GUM (● 8-0855)



57-0002

● 8-0855



Aufgrund der Besonderheiten des Materials (recyceltes PET-Material) sind produktionstechnische Farbschwankungen gegeben.

Due to the special nature of the material (recycled PET material) production-related variations are possible.



Die Gewinnung und Verarbeitung des rPET-Materials aus 100% recycelten PET-Flaschen sowie das rAL-Material aus 100% recycelten Aluminium-Getränkedosen findet in Europa statt. Die beiden Materialien eignen sich für einen langlebigen und nachhaltigen Werbeeinsatz. Dank der europäischen und ClimatePartner-zertifizierten Produktion leistet der uma RECYCLED PET PEN PRO einen zusätzlichen nachhaltigen Beitrag zur Schonung der Umwelt.

The extraction and processing of the rPET material from 100% recycled PET bottles, as well as the rAL material from 100% recycled aluminium beverage cans takes place in Europe. Both materials are suitable for a durable and sustainable advertisement. Thanks to the European and ClimatePartner-certified production, the uma RECYCLED PET PEN PRO makes an additional sustainable contribution to the protection of the environment.

0-2250 F-SI GUM ◊

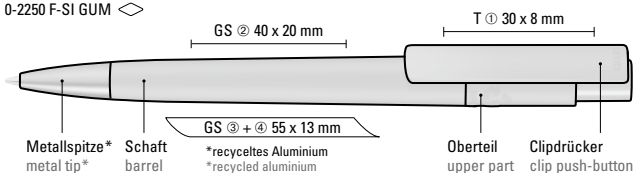

0-2250 F-SI GUM: Druckkugelschreiber mit gummiertem Gehäuse aus recyceltem PET-Material mit matt gedecktem Clip sowie Metallspitze aus recyceltem Aluminium in silber matt.

Werbeschlüssel

Schaft GS, Clip T

0-2250 F-SI GUM: Retractable ballpoint pen with softtouch housing made from recycled PET material with opaque matt clip, metal tip made from recycled aluminium in matt silver.

Advertising code

barrel GS, clip T

RECYCLED PET PEN PRO ocean



made from ocean-bound plastic



Produkt-Video/
product video

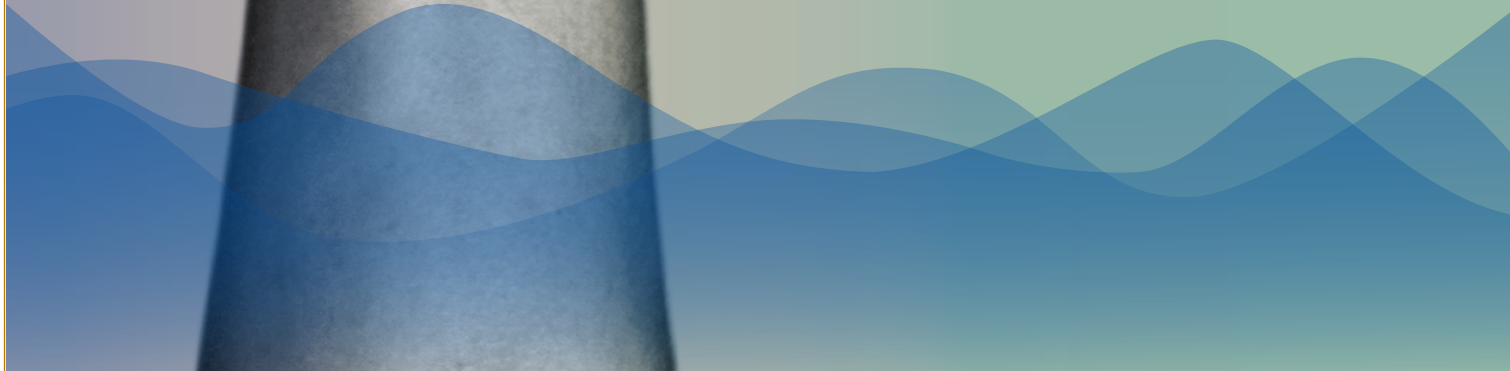

0-2250 F OCEAN (● 8-0854)



Aufgrund der Besonderheiten des Materials (recyceltes PET-Material) sind produktionstechnische Farbschwankungen gegeben.

Due to the special nature of the material (recycled PET material) production-related variations are possible.



Etui Empfehlung / Case suggestion
ETUI 0-0940 CI OCEAN

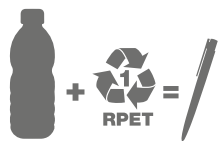

made from ocean-bound plastic

Das durch Plastic Bank gesammelte Ocean Bound Plastic, auch bekannt als Social Plastic®, wird in Europa zu einem recycelten PET Schreibgerät für einen langlebigen und nachhaltigen Werbeeinsatz upgecycelt. Dank der europäischen und ClimatePartner-zertifizierten Produktion leistet der uma RECYCLED PET PEN PRO F ocean einen zusätzlichen nachhaltigen Beitrag zur Schonung der Umwelt.

Ocean-bound plastic, also known as Social Plastic®, collected through Plastic Bank is upcycled in Europe into a recycled PET writing instrument for long-lasting and sustainable advertisement. Thanks to the European and ClimatePartner-certified production, the uma RECYCLED PET PEN PRO F ocean makes an additional sustainable contribution to the protection of the environment.

0-2250 F OCEAN ◀▶

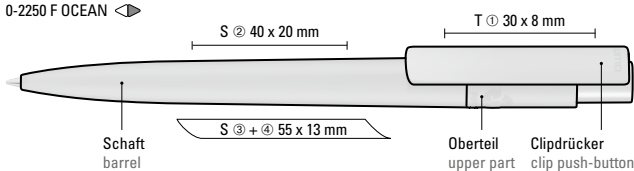

Mix n' Match: Ab 2.000 Stück kann das Modell farblich kombiniert werden.
0-2250 F OCEAN: Druckkugelschreiber aus recyceltem PET-Material aus Ocean Bound Plastic mit matt gedecktem Gehäuse und Clip.

Werbeschlüssel

Schaft S, Clip T

Mix n' Match: From 2,000 pieces, you can choose any colour combination.
0-2250 F OCEAN: Retractable ballpoint pen made from ocean-bound PET material with opaque matt housing and clip.

Advertising code

barrel S, clip T



ANTIBAKTERIELL UND ANTIVIRAL

Der antimikrobielle Zusatz verleiht dem rPET eine antibakterielle und antivirale Wirkung.

Die antimikrobielle Wirkung ist für die gesamte Lebensdauer des Schreibgerätes gewährleistet und bietet somit einen dauerhaften Schutz.



GEPRÜFT UND ZERTIFIZIERT

Die Haftung und Ansiedelung von Krankheitserregern auf der Oberfläche des Schreibgerätes wird nachweislich zu 99,99% reduziert.

Geprüft nach ISO 21702 (antiviral) und ISO 22196 (antibakteriell). Sowohl Bakterien als auch Viren (auch das Corona Virus) werden vernichtet.



MADE IN EUROPE

Kurze und schnelle Lieferwege ermöglichen eine zuverlässige und kurzfristige Produktion und schaffen einen zusätzlichen Beitrag zum Erhalt der Umwelt.



KLIMAOPTIMIERT

Die Schreibgeräte werden in Europa produziert und ClimatePartner-zertifiziert veredelt. Auf diese Weise wird ein zusätzlich positiver Beitrag für die Umwelt geleistet.



RECYCELT

Das Gehäuse wird zu 100% aus recycelten PET-Flaschen hergestellt. Somit wurde bereits ein Recycling-Prozess umgesetzt und das Produkt kann wieder dem Recyclingzyklus zugeführt werden.

ANTIBACTERIAL AND ANTIVIRAL

It is made of antibacterial and antiviral plastic containing a special additive which prevents bacteria from colonising the surface of the pen.

TESTED AND CERTIFIED

Laboratory tests have shown that up to 99.99% of bacteria and pathogens on the surface of writing instruments are eliminated. Tested according to ISO 21702 (antiviral) and ISO 22196 (antibacterial) effect is guaranteed for the entire life of the writing instrument and thus offers lasting protection.

MADE IN EUROPE

Short and fast delivery routes enable reliable and short-term production and create an additional contribution to the preservation to the environment.

CLIMATE-OPTIMISED

The writing instruments are produced in Europe and finished ClimatePartner-certified in the Black Forest. In this way, an additional positive contribution to the environment is made.

RECYCLED

The barrel is made of 100% recycled PET bottles. With the use of uma RECYCLED PET PENs we assure you that a recycling process has already been supported and that the writing instruments can be fed into further recycling cycles.



Etui Empfehlung / Case suggestion

0-0940 CI ANTIBAC

Pappstecketui aus FSC®-zertifiziertem Pappkarton für ein Schreibgerät mit aufgedruckter Erklärung zum uma RECYCLED PET PEN PRO antibacterial

Cardboard slip-in case made of FSC® certified cardboard for one writing instrument with printed declaration of uma RECYCLED PET PEN PRO antibacterial

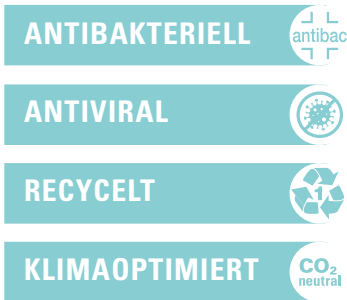

Aufgrund der Besonderheiten des Materials (recyceltes PET-Material) sind produktionstechnische Farbschwankungen gegeben.

Due to the special nature of the material (recycled PET material) production-related variations are possible.



Das aus recycelten PET-Flaschen in Europa hergestellte rPET-Material eignet sich für langlebigen und nachhaltigen Werbeeinsatz. Der uma RECYCLED PET PEN PRO antibacterial bietet gleichzeitig mehrere Verkaufsargumente: recycelt, umweltverträglich, ClimatePartner-zertifiziert, antibakteriell und antiviral.

The rPET material, which is produced in Europe from recycled PET bottles, is suitable for a durable and sustainable advertisement. The uma RECYCLED PET PEN PRO antibacterial offers several sales arguments: recycled, environmentally friendly, ClimatePartner-certified, antibacterial and antiviral.

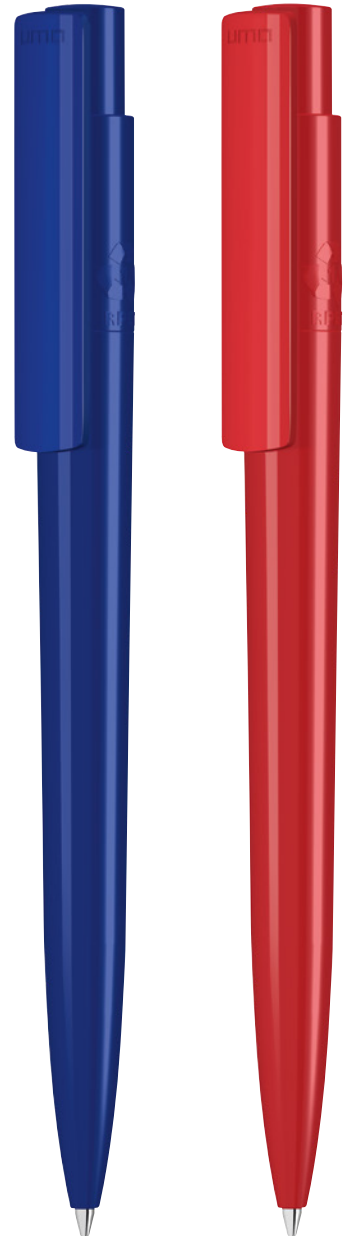

Mix n' Match: Ab 2.000 Stück kann das Modell farblich kombiniert werden.

0-2250 ANTIBAC: Druckkugelschreiber aus recyceltem, antibakteriellem und antiviralem rPET in gedeckt glänzendem Gehäuse und Clip. Der nach ISO 22196 und ISO 21702 geprüfte antimikrobielle Zusatz verleiht dem rPET eine antibakterielle und antivirale Wirkung auch gegen Corona-Viren. Die Haftung und Ansiedlung von Bakterien oder Krankheitserregern auf der Oberfläche des Schreibgerätes wird um 99,99% verringert. Der in das rPET Material eingearbeitete antimikrobielle Zusatz kann nicht abgerieben oder abgegeben werden und wirkt über die gesamte Lebensdauer des Schreibgerätes. Eine dauerhafte Reduzierung von Krankheitserregern ist gegeben.

Mix n' Match: From 2,000 pieces, you can choose any colour combination.

0-2250 ANTIBAC: Retractable ballpoint pen made from recycled, antibacterial and antiviral recycled PET material with opaque glossy housing and clip. The ISO 22196 and ISO 21702 tested antimicrobial additive of silver ions gives the rPET material an antibacterial and antiviral effect that reduces the adhesion and settling of bacteria or pathogens on the surface of the writing instrument by 99.99%. The antimicrobial additive incorporated into the rPET material cannot be rubbed off or released and is effective over the entire life of the writing instrument. A permanent reduction of pathogens is given.

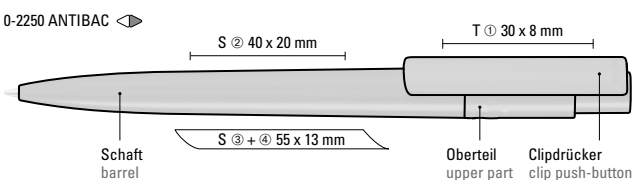

Werbeschlüssel

Schaft S, Clip T

Advertising code

barrel S, clip T



0-2250 F TO (● 8-0854)



57-0002



● 8-0854



Aufgrund der Besonderheiten des Materials (recyceltes PET-Material) sind produktionstechnische Farbschwankungen gegeben.

Due to the special nature of the material (recycled PET material) production-related variations are possible.



ClimatePartner
zertifiziertes Produkt
climate-id.com/DIPVA4



Das aus recycelten PET-Flaschen in Europa hergestellte rPET-Material eignet sich für einen langlebigen und nachhaltigen Werbeeinsatz. Dank der europäischen und ClimatePartner-zertifizierten Produktion leistet der uma RECYCLED PET PEN PRO F TOUCH einen zusätzlichen nachhaltigen Beitrag zur Schonung der Umwelt.

The rPET material, which is produced in Europe from recycled PET bottles, is suitable for a durable and sustainable advertisement. Thanks to the European and ClimatePartner-certified production, the uma RECYCLED PET PEN PRO F TOUCH makes an additional sustainable contribution to the protection of the environment.

0-2250 F TO ◊

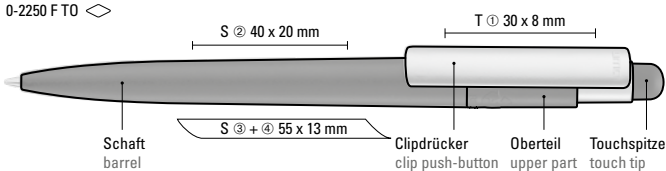

0-2250 F TO: Druckkugelschreiber aus recyceltem PET-Material mit matt gedecktem Gehäuse und silbernem Clip, Drücker mit integrierter Touchscreensteuerung.

0-2250 F TO: Retractable ballpoint pen made from recycled PET material with opaque matt housing and silver clip, push-button with integrated touch screen control.

Werbeschlüssel

Schaft S, Clip T

Advertising code

barrel S, clip T



RECYCLED PET PEN ALUMA



Die Gewinnung und Verarbeitung des rPET Materials aus 100% recycelten PET-Flaschen sowie das rAL-Material aus 100% recycelten Aluminium-Getränkedosen findet in Europa statt. Die beiden Materialien eignen sich für einen langlebigen und nachhaltigen Werbeeinsatz. Dank der europäischen und ClimatePartner-zertifizierten Produktion leistet der uma RECYCLED PET PEN ALUMA einen zusätzlichen nachhaltigen Beitrag zur Schonung der Umwelt.

Aufgrund der Besonderheiten des Materials (recyceltes PET-Material) sind produktionstechnische Farbschwankungen gegeben.

The extraction and processing of the rPET material from 100% recycled PET bottles, as well as the rAL material from 100% recycled aluminium beverage cans takes place in Europe. Both materials are suitable for a durable and sustainable advertisement. Thanks to the European and ClimatePartner-certified production, the uma RECYCLED PET PEN ALUMA makes an additional sustainable contribution to the protection of the environment.

Due to the special nature of the material (recycled PET material) production-related variations are possible.



Etui Empfehlung/Case suggestion
ETUI 0-0940 CI ALUMA

0-7200 (● 8-0855)
0-7200 T (● 8-0856)

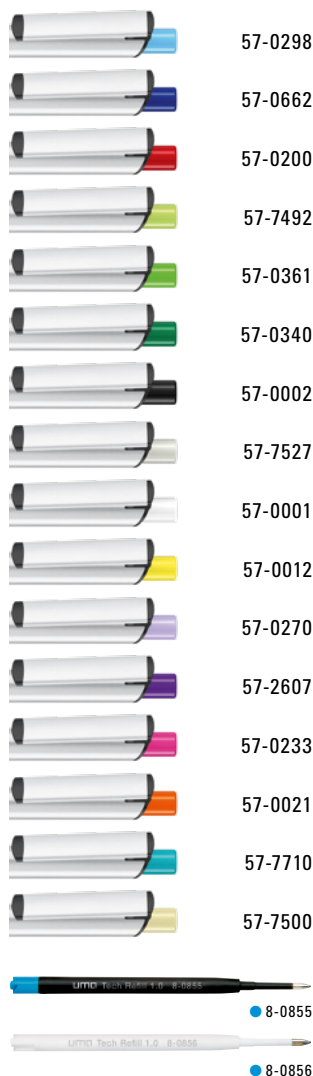

Die Modelle eignen sich für eine Lasergravur in weiß.

The models are suitable for laser engraving in white.



0-7200: Metall-Druckkugelschreiber mit Metallspitze, Metallschaft und Metallclip aus recyceltem Aluminium, Kunststoffteile aus recyceltem PET-Material in gedeckt schwarz und gedeckt farbigem Drücker.

0-7200 T: Metall-Druckkugelschreiber mit Metallspitze, Metallschaft und Metallclip aus recyceltem Aluminium, Kunststoffteile aus recyceltem PET-Material in klar transparent und gedeckt farbigem Drücker.

0-7200: Metal retractable ballpoint pen with metal tip, metal barrel and metal clip made from recycled aluminium in matt silver, plastic parts made from recycled PET material in opaque glossy black and opaque coloured push-button.

0-7200 T: Metal retractable ballpoint pen with metal tip, metal barrel and metal clip made from recycled aluminium in matt silver, plastic parts made from recycled PET material in opaque clear transparent and opaque coloured push-button.

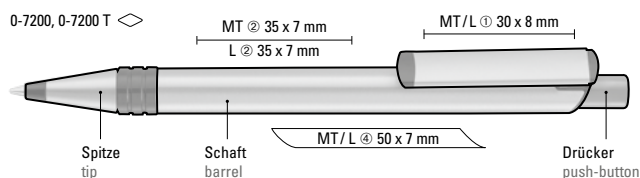

Werbeschlüssel

Schaft MT/L,
Clip MT/L

Advertising code

barrel MT/L,
clip MT/L

RECYCLED PET PEN
0-2260

RECYCLED PET PEN transparent SG
0-2260 T SG

Farb-Code/Minen
Colour code/Refills



0-2260 (● 8-0866)
0-2260 T SG (● 8-0866)

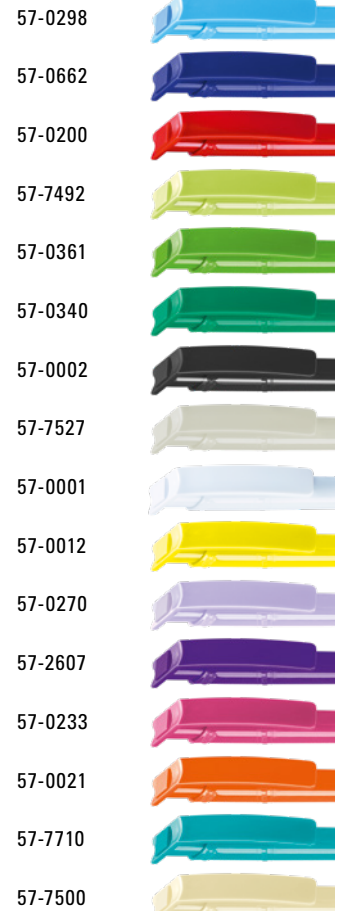

Das aus recycelten PET-Flaschen in Europa hergestellte rPET-Material eignet sich für einen langlebigen und nachhaltigen Werbeeinsatz. Dank der europäischen und ClimatePartner-zertifizierten Produktion leistet der uma RECYCLED PET PEN einen zusätzlichen nachhaltigen Beitrag zur Schonung der Umwelt.

Mix n' Match: Ab 2.000 Stück kann das Modell farblich kombiniert werden.

0-2260: Druckkugelschreiber aus recyceltem rPET-Material mit gedecktem glänzendem Gehäuse und Stopfen.

0-2260 T SG: Druckkugelschreiber aus recyceltem rPET-Material mit klar transparent glänzendem Gehäuse und gedecktem Stopfen.

Werbeschlüssel

Schaft S, Clip T,
Stopfen TT

The rPET material, which is produced in Europe from recycled PET bottles, is suitable for a durable and sustainable advertisement. Thanks to the European and ClimatePartner-certified production, the uma RECYCLED PET PEN makes an additional sustainable contribution to the protection of the environment.

Mix n' Match: From 2,000 pieces, you can choose any colour combination.

0-2260: Retractable ballpoint pen made from recycled PET material with opaque glossy housing and plug.

0-2260 T SG: Retractable ballpoint pen made from recycled PET material with clear transparent housing and opaque glossy plug.

Advertising code

barrel S, clip T,
plug TT



ClimatePartner
zertifiziertes Produkt
climate-id.com/DIPVA4



0-2260 ◀, 0-2260 T SG ▶

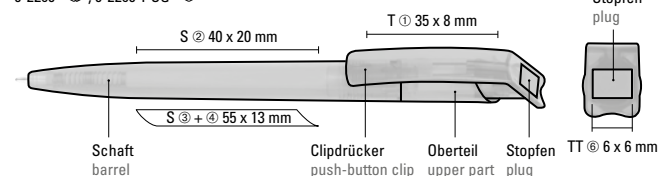

0-2260 T (● 8-0866)



Aufgrund der Besonderheiten des Materials (recycltes PET-Material) sind produktionstechnische Farbschwankungen gegeben.
Due to the special nature of the material (recycled PET material) production-related variations are possible.



Das aus recycelten PET-Flaschen in Europa hergestellte rPET-Material eignet sich für einen langlebigen und nachhaltigen Werbeeinsatz. Dank der europäischen und ClimatePartner-zertifizierten Produktion leistet der uma RECYCLED PET PEN einen zusätzlichen nachhaltigen Beitrag zur Schonung der Umwelt.

The rPET material, which is produced in Europe from recycled PET bottles, is suitable for a durable and sustainable advertisement. Thanks to the European and ClimatePartner-certified production, the uma RECYCLED PET PEN makes an additional sustainable contribution to the protection of the environment.

0-2260 T ◀

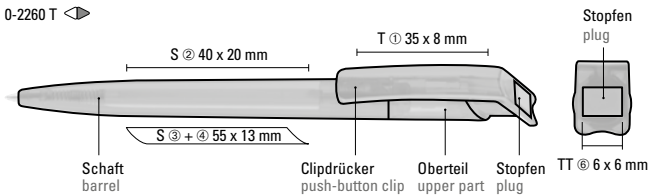

Mix n' Match: Ab 2.000 Stück kann das Modell farblich kombiniert werden.

0-2260 T: Druckkugelschreiber aus recyceltem rPET-Material mit transparent glänzendem Gehäuse und gedecktem Stopfen.

Werbeschlüssel

Schaft S, Clip T, Stopfen TT

Mix n' Match: From 2,000 pieces, you can choose any colour combination.

0-2260 T: Retractable ballpoint pen made from recycled PET material with transparent glossy housing and opaque glossy plug.

Advertising code

barrel S, clip T, plug TT

RECYCLED PET PEN switch
0-2240

RECYCLED PET PEN switch transparent
0-2240 T

Farb-Code/Minen
Colour code/Refills



0-2240 (● 8-0866)	0-2240 T (● 8-0866)
57-0298	57-0286
57-0662	57-0185
57-0200	57-0355
57-7492	57-0440
57-0361	57-0291
57-0340	57-0107
57-0002	57-0260
57-7527	57-0226
57-0001	57-0151
57-0012	57-3295
57-0270	
57-2607	
57-0233	
57-0021	
57-7710	
57-7500	

Aufgrund der Besonderheiten des Materials (recyceltes PET-Material) sind produktionstechnische Farbschwankungen gegeben.
Due to the special nature of the material (recycled PET material) production-related variations are possible.

Das aus recycelten PET-Flaschen in Europa hergestellte rPET-Material eignet sich für einen langlebigen und nachhaltigen Werbeinsatz. Dank der europäischen und ClimatePartner-zertifizierten Produktion leistet der RECYCLED PET PEN switch einen zusätzlichen nachhaltigen Beitrag zur Schonung der Umwelt.

The rPET material, which is produced in Europe from recycled PET bottles, is suitable for a durable and sustainable advertisement. Thanks to the European and ClimatePartner-certified production, the RECYCLED PET PEN switch makes an additional sustainable contribution to the protection of the environment.

0-2240: Drehkugelschreiber aus recyceltem rPET-Material mit gedeckt glänzendem Gehäuse.

0-2240: Twist ballpoint pen made from recycled PET material with opaque glossy housing.

0-2240 T: Drehkugelschreiber aus recyceltem rPET-Material mit transparent glänzendem Gehäuse.

0-2240 T: Twist ballpoint pen made from recycled PET material with transparent glossy housing.

Werbeschlüssel Schaft S, Clip T

Advertising code barrel S, clip T

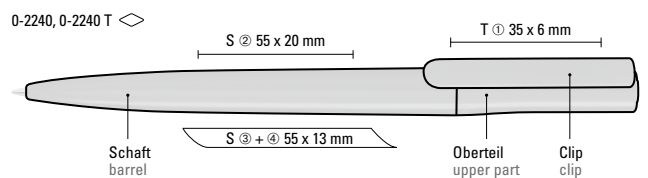

0-0093 ANTIBAC (● 8-0854)

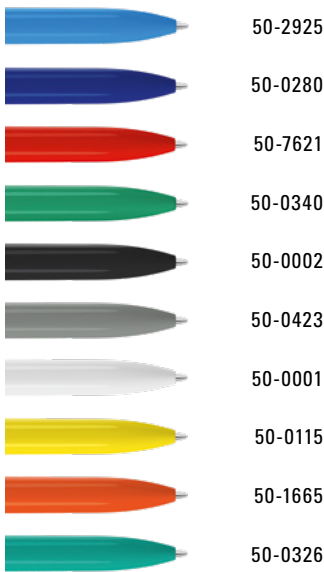

0-0092 RECY (● 8-0854)

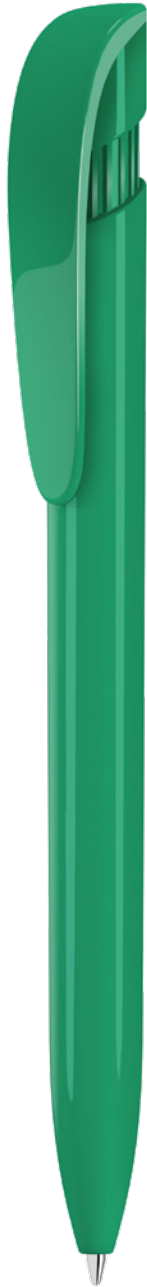
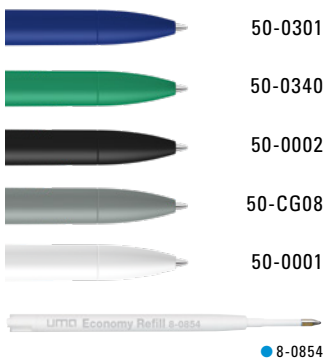

Hinweis im Schaft aufgedruckt:
„antibacterial“
Note printed on the barrel
„antibacterial“



Das Modell ist mit dem Recyclingzeichen gekennzeichnet. Dank der ClimatePartner-zertifizierten Produktion leistet der uma YES RECY einen zusätzlichen nachhaltigen Beitrag zur Schonung der Umwelt. Aufgrund der Besonderheit des Materials (ABS Recycled Plastic) sind produktionstechnische Farbschwankungen gegeben. The model is labelled with the recycling mark. Thanks to the ClimatePartner-certified production, the uma YES RECY makes an additional sustainable contribution to the protection of the environment. Due to the special nature of the material (ABS recycled plastic) colour variations may occur during the production process.

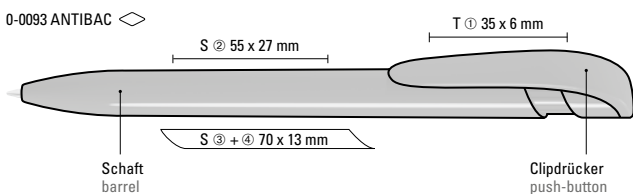

0-0093 ANTIBAC: Druckkugelschreiber mit gedeckt glänzendem, antibakteriellen Gehäuse und breitem Bogenclipdrücker. Der nach ISO 22196:2011 geprüfte antimikrobielle Zusatz aus Silberionen verleiht dem Kunststoff eine antibakterielle Wirkung, die eine Haftung und Ansiedlung von Bakterien oder Krankheitserregern auf der Oberfläche des Schreibgerätes um 99,99% verringert.

0-0093 ANTIBAC: Retractable ballpoint pen with opaque glossy antibacterial housing and wide curved clip button. The antimicrobial additive of silver ions, tested according to ISO 22196:2011, gives the plastic an antibacterial effect that reduces the adhesion and settling of bacteria or pathogens on the surface of the writing instrument by 99.99%.

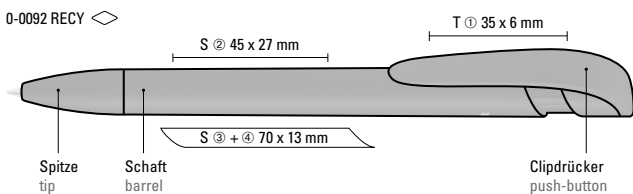

0-0092 RECY: Druckkugelschreiber mit gedeckt mattem Gehäuse, breitem Bogenclipdrücker und Spitze aus recyceltem Kunststoff.

0-0092 RECY: Retractable ballpoint pen with opaque matt housing, wide curved clip button and tip made from recycled plastic.

Werbeschlüssel Schaft S ◊, Clip T

Advertising code barrel S ◊, clip T



1-0736 RECY (● 8-0877)



Aufgrund der Besonderheit des Materials (ABS Recycled Plastic) sind produktionstechnische Farbschwankungen gegeben.

Due to the special nature of the material (ABS recycled plastic) colour variations may occur during the production process.



ClimatePartner
zertifiziertes Produkt
climate-id.com/DIPVA4

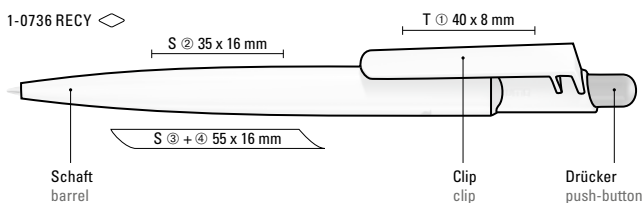

Das Modell ist mit dem rABS Logo gekennzeichnet. Dank der ClimatePartner-zertifizierten Produktion leistet der uma VITAN RECY einen zusätzlichen nachhaltigen Beitrag zur Schonung der Umwelt.

1-0736 RECY: Druckkugelschreiber mit gedeckt glänzendem Gehäuse aus 100% recyceltem Kunststoff und großem Clip an verstärkter Clipanbindung.

Werbeschlüssel Schaft S ○, Clip T

The model is labelled with the recycling mark. Thanks to the ClimatePartner-certified production, the uma VITAN RECY makes an additional sustainable contribution to the protection of the environment.

1-0736 RECY: Retractable ballpoint pen with opaque glossy body and large clip made from 100% recycled plastic.

Advertising code barrel S ○, clip T

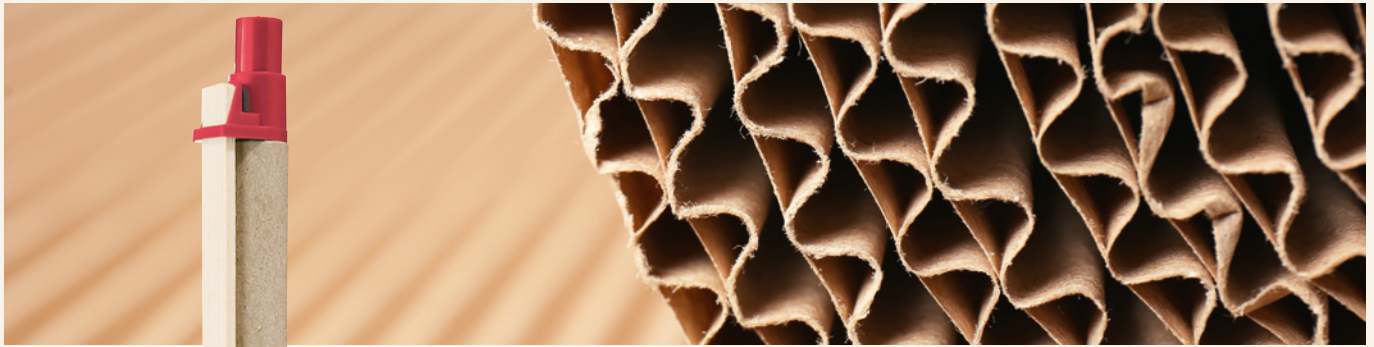

Recyclerter Karton

Die Verwendung von bereits **recyclerter Kartonage** bietet eine stabile und zugleich umweltverträgliche Grundlage für die Herstellung von Schreibgeräten. Das Material kann dem Recyclingprozess wieder zugeführt werden und trägt so zur Umweltschonung bei. Die Verwendung dieser besonderen Materialien sind produktionstechnischen Schwankungen unterlegen. Leichte Unterschiede in Farbe und Oberfläche sind daher möglich.

Recycled cardboard

The use of **cardboard** that has already been **recycled** offers a stable and at the same time environmentally friendly basis for the production of writing utensils. The material can be returned to the recycling process again, thus contributing to helping the environment. The use of these special materials is subject to fluctuations in the production technology. As a result, slight differences in colour and surface are possible.

Das Gehäuse des PAPER PENs wird aus recyclerter Kartonage hergestellt.

The housing of the PAPER PEN is made of recycled cardboard.

PAPER PEN
6-2250 H



Cellulose

Der aus der Natur gewonnene Rohstoff kann dieser ebenfalls wieder zugeführt werden. Das **Celluloseacetat** entspricht der DIN EN 13432:2000-12/Zertifizierungsprogramm für Produkte aus kompostierbaren Werkstoffen. Die hierfür notwendige Cellulose wird aus europäischen Weichhölzern gewonnen.

Cellulose acetate

The raw material gained from nature can also be returned to nature. The **cellulose acetate** complies with DIN EN 13432:2000-12/certification program for products from compostable materials. The cellulose required for this is gained from European softwoods.

Das Gehäuse des BIO-PENs wird aus Celluloseacetat gefertigt und ist mit dem BIO-PEN-Logo gekennzeichnet.

The housing of the BIO-PEN is made of cellulose acetate and is marked with the BIO-PEN logo.

BIO PEN
6-3550





rABS – recyclerter Kunststoff

Recyclerter ABS-Kunststoff wird aus den **Spritzgussresten** der eigenen Spritzgießerei gewonnen. Hierzu werden die Kunststoffabfälle gesammelt und dem Spritzgussprozess wieder zugeführt. Die gesammelten Kunststoffe können sortenrein und qualitätsbestimmt gesammelt werden. Durch das Aufbereiten der Kunststoffe kann aus diesen ein recyceltes Produkt gefertigt werden. Generell wird durch das Recyceln der Kunststoffe weniger Rohöl und Energie verbraucht.

rABS – recycled plastic

Recycled ABS plastic is obtained from the **injection moulding** debris from our own injection moulding plant. For this, plastic waste is collected up and directed back into the injection moulding process. The collected plastics can be collected, graded and grouped by quality standard. These preparatory operations with plastics are the key to manufacturing a recycled product. Without exception, the recycling of plastics uses less crude oil and power.

Das Gehäuse des HAPPY RECY wird aus recyceltem ABS Kunststoff hergestellt und ist mit dem rABS Logo gekennzeichnet.

The housing of the HAPPY RECY is made of recycled plastics (ABS) and is marked with the rABS logo.

HAPPY RECY
0-0037 RECY



rPCP – recyclerter Post-Consumer-Kunststoff

Recyclerter Post-Consumer-Kunststoff (PCP) wird meist aus technischen (Haushalts-) Geräten oder sonstigen **Consumer Kunststoffabfällen** gewonnen. Hierzu werden die Kunststoffe gesammelt und sortenrein recycelt. Die sogenannten Post Consumer oder Post Industry Kunststoffe können nach der Aufbereitung in ein neues Produkt upgecycelt werden. Generell wird durch das Recyceln der Kunststoffe weniger Rohöl und Energie verbraucht.

rPCP – recycled post-consumer plastic

For the most part, recycled post-consumer plastic (PCP) is obtained from technical (domestic) appliances or other forms of **plastic consumer waste**. This process involves collecting and grading plastics and recycling each grade separately. After the recycling process, a new product can be 'upcycled' from what are known as post-consumer or also post industry plastics. Without exception, the recycling of plastics uses less crude oil and power.

Das Gehäuse des ICONIC RECY wird aus recyceltem Post-Consumer-Kunststoff (PCP) hergestellt und ist mit dem POST-CONSUMER-RECYCLED-PLASTIC-Logo gekennzeichnet.

The housing of the ICONIC RECY is made of recycled Post-Consumer plastics (PCP) and is marked with the POST-CONSUMER RECYCLED PLASTIC logo.

ICONIC RECY
0-0057 RECY



0-0133 RECY (● 8-0855)
0-0133 SI RECY (● 8-0855)



Etui Empfehlung/Case suggestion
ETUI 0-0933 CI
Seite 281/page 281



Aufgrund der Besonderheit des Materials (ABS Recycled Plastic) sind produktionstechnische Farbschwankungen gegeben.

Due to the special nature of the material (ABS recycled plastic) colour variations may occur during the production process.



0-0133 RECY, 0-0133 SI RECY* ◊

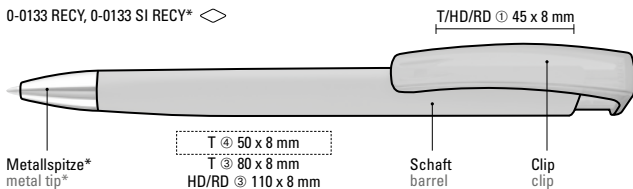

Das Modell ist mit dem Recyclingzeichen gekennzeichnet. Dank der europäischen und ClimatePartner-zertifizierten Produktion leistet der uma TRINITY RECY einen zusätzlichen nachhaltigen Beitrag zur Schonung der Umwelt.

0-0133 RECY: Druckkugelschreiber mit gedeckt mattem Dreikantgehäuse und glänzendem Clip aus recyceltem ABS-Kunststoff.

0-0133 SI RECY: Druckkugelschreiber mit gedeckt mattem Dreikantgehäuse und glänzendem Clip aus recyceltem ABS-Kunststoff, schwere Metallspitze glanzverchromt.

Werbeschlüssel

Schaft T/HD/RD,
Clip T/HD/RD

The model is labelled with the recycling mark. Thanks to the European and ClimatePartner-certified production, the uma TRINITY RECY makes an additional sustainable contribution to the protection of the environment.

0-0133 RECY: Retractable ballpoint pen with opaque matt triangular housing and glossy clip made from recycled ABS plastic.

0-0133 SI RECY: Retractable ballpoint pen with opaque matt triangular housing and glossy clip made from recycled ABS plastic and heavy metal tip chrome plated.

Advertising code

barrel T/HD/RD,
clip T/HD/RD



0-0133 KT RECY (● 8-0855)
0-0133 KT-SI RECY (● 8-0855)



Aufgrund der Besonderheit des Materials (ABS Recycled Plastic) sind produktionstechnische Farbschwankungen gegeben.

Due to the special nature of the material (ABS recycled plastic) colour variations may occur during the production process.



0-0133 KT RECY, 0-0133 KT-SI RECY* ◊

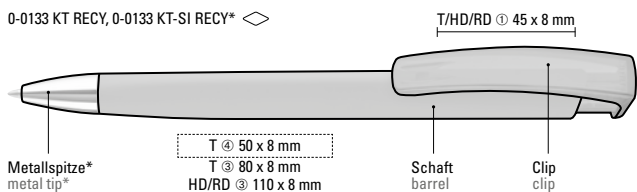

Das Modell ist mit dem Recyclingzeichen gekennzeichnet. Dank der europäischen und ClimatePartner-zertifizierten Produktion leistet der uma TRINITY RECY einen zusätzlichen nachhaltigen Beitrag zur Schonung der Umwelt.

0-0133 KT RECY: Druckkugelschreiber mit gedeckt mattem Dreikantgehäuse und transparent glänzendem Clip aus recyceltem ABS-Kunststoff.

0-0133 KT-SI RECY: Druckkugelschreiber mit gedeckt mattem Dreikantgehäuse, transparent glänzendem Clip aus recyceltem ABS-Kunststoff und schwerer Metallspitze glanzverchromt.

Werbeschlüssel

Schaft T/HD/RD,
Clip T/HD/RD

The model is labelled with the recycling mark. Thanks to the European and ClimatePartner-certified production, the uma TRINITY RECY makes an additional sustainable contribution to the protection of the environment.

0-0133 KT RECY: Retractable ballpoint pen with opaque matt triangular housing and transparent glossy clip made from recycled ABS plastic.

0-0133 KT-SI RECY: Retractable ballpoint pen with opaque matt triangular housing, transparent glossy clip made from recycled ABS plastic and heavy metal tip chrome plated.

Advertising code

barrel T/HD/RD,
clip T/HD/RD



0-0037 RECY (● 8-0865)



Aufgrund der Besonderheit des Materials (ABS Recycled Plastic) sind produktionstechnische Farbschwankungen gegeben.

Due to the special nature of the material (ABS recycled plastic) colour variations may occur during the production process.

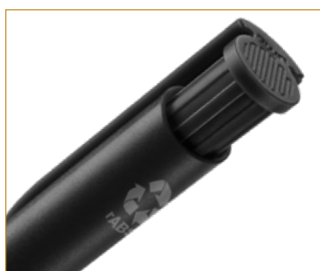

UMA[®]
PRIME



Die Modelle von HAPPY und HAPPY frozen finden Sie auf Seite 130-131.

The models HAPPY and HAPPY frozen can be found on page 130-131.

Das Modell ist mit dem Recyclingzeichen gekennzeichnet. Dank der ClimatePartner-zertifizierten Produktion leistet der uma HAPPY RECY einen zusätzlichen nachhaltigen Beitrag zur Schonung der Umwelt.

The model is labelled with the recycling mark. Thanks to the ClimatePartner-certified production, the uma HAPPY RECY makes an additional sustainable contribution to the protection of the environment.

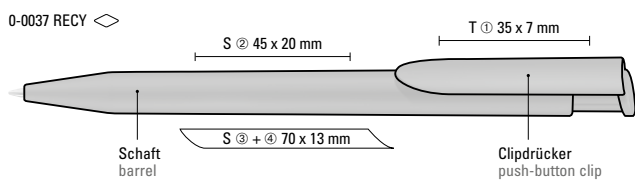

0-0037 RECY: Druckkugelschreiber mit gedeckt mattem Gehäuse und Clipdrücker aus recyceltem Kunststoff.

0-0037 RECY: Retractable ballpoint pen with opaque matt housing and clip button made from recycled plastic.

Werbeschlüssel Schaft S ○, Clip T

Advertising code barrel S ○, clip T



0-0063 F RECY (● 8-0866)

32-0292	
32-2175	
32-0200	
32-0382	
32-0348	
32-0002	
32-0001	
32-0115	
32-2685	
32-0213	
32-1585	
32-3262	
● 8-0866	



Aufgrund der Besonderheit des Materials (ABS Recycled Plastic) sind produktionstechnische Farbschwankungen gegeben.

Due to the special nature of the material (ABS recycled plastic) colour variations may occur during the production process.

Das Modell ist mit dem Recyclingzeichen gekennzeichnet. Dank der europäischen und ClimatePartner-zertifizierten Produktion leistet der uma ON TOP F RECY einen zusätzlichen nachhaltigen Beitrag zur Schonung der Umwelt.

0-0063 F RECY: Druckkugelschreiber mit gedeckt mattem Gehäuse, Clip, Drücker und Stopfen aus recyceltem ABS-Kunststoff.

Werbeschlüssel

Schaft S ◯,
Clip T/HD/RD

The model is labelled with the recycling mark. Thanks to the European and ClimatePartner-certified production, the uma ON TOP F RECY makes an additional sustainable contribution to the protection of the environment.

0-0063 F RECY: Retractable ballpoint pen with opaque matt housing, clip, push-button and plug made from recycled ABS plastic.

Advertising code

barrel S ◯,
clip T/HD/RD



ClimatePartner
zertifiziertes Produkt
climate-id.com/DIPVA4

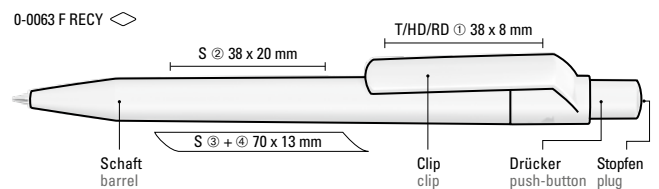

0-0063 RECY (● 8-0866)



Drücker/Stopfen ABS
push-button/plug ABS

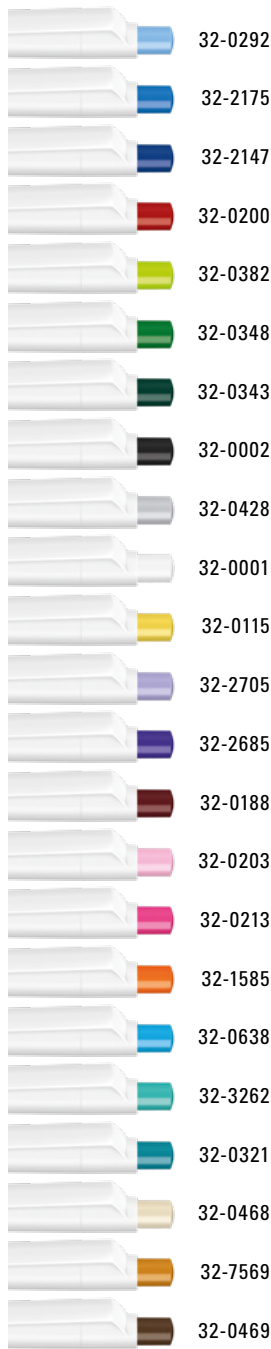

0-0063 RECY:
Drücker und Stopfen sind ab
2.000 Stück auch in allen
glänzend gedeckten ABS
Standardfarben erhältlich.

0-0063 RECY:
From 2,000 units, push-buttons
and plugs are available in all sol-
id shiny ABS standard colours.



Aufgrund der Besonderheit des
Materials (Post-Consumer
Recycled Plastic) sind
produktionstechnische
Farbschwankungen gegeben.

Due to the special nature of the
material (post-consumer recycled
plastic) colour variations may
occur during the production
process.



Das Modell ist mit dem Recyclingzeichen
gekennzeichnet. Dank der europäischen
und ClimatePartner-zertifizierten
Produktion leistet der uma ON TOP RECY
einen zusätzlichen nachhaltigen Beitrag
zur Schonung der Umwelt.

The model is labelled with the recycling
mark. Thanks to the European and
ClimatePartner-certified production, the
uma ON TOP RECY makes an additional
sustainable contribution to the
protection of the environment.

0-0063 RECY ◀

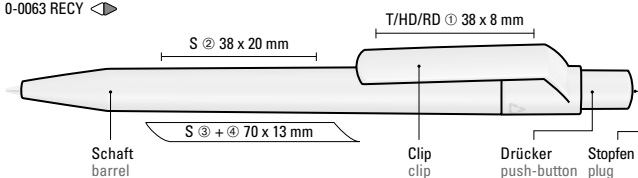

Mix n' Match: Ab 2.000 Stück kann das
Modell farblich kombiniert werden.

0-0063 RECY: Druckkugelschreiber mit
gedeckt mattem Gehäuse, Clip, Drücker
und Stopfen aus 100% recyceltem
Post-Consumer-Kunststoff.

Werbeschlüssel Schaft S, Clip T/HD/RD

Mix n' Match: From 2,000 pieces, you
can choose any colour combination.

0-0063 RECY: Retractable ballpoint pen
with opaque matt housing, clip,
push-button and plug made from 100%
recycled post-consumer plastic.

Advertising code barrel S, clip T/HD/RD



0-0057 RECY (● 8-0866)



POST-CONSUMER
RECYCLED PLASTIC

Aufgrund der Besonderheit des Materials (Post-Consumer Recycled Plastic) sind produktionstechnische Farbschwankungen gegeben.

Due to the special nature of the material (post-consumer recycled plastic) colour variations may occur during the production process.



ClimatePartner
zertifiziertes Produkt
climate-id.com/DIPVA4



Das Modell ist mit dem Recyclingzeichen gekennzeichnet. Dank der europäischen und ClimatePartner-zertifizierten Produktion leistet der uma ICONIC RECY einen zusätzlichen nachhaltigen Beitrag zur Schonung der Umwelt.

The model is labelled with the recycling mark. Thanks to the European and ClimatePartner-certified production, the uma ICONIC RECY makes an additional sustainable contribution to the protection of the environment.

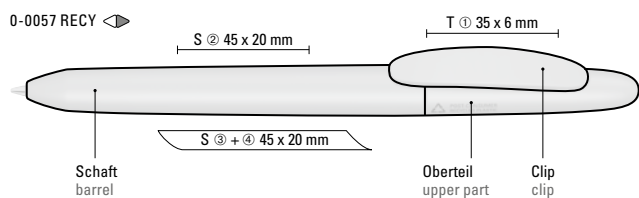

Mix n' Match: Ab 2.000 Stück kann das Modell farblich kombiniert werden.

Mix n' Match: From 2,000 pieces, you can choose any colour combination.

0-0057 RECY: Drehkugelschreiber mit gedeckt mattem Gehäuse aus 100% recyceltem Post-Consumer-Kunststoff.

0-0057 RECY: Twist ballpoint pen with opaque matt housing made from 100% recycled post-consumer plastic.

Werbeschlüssel

Schaft S, Clip T

Advertising code

barrel S, clip T



0-0183 RECY (● 8-0866)



Aufgrund der Besonderheit des Materials (Post-Consumer Recycled Plastic) sind produktionstechnische Farbschwankungen gegeben.

Due to the special nature of the material (post-consumer recycled plastic) colour variations may occur during the production process.

Das Modell ist mit dem Recyclingzeichen gekennzeichnet. Dank der europäischen und ClimatePartner-zertifizierten Produktion leistet der uma VANE RECY einen zusätzlichen nachhaltigen Beitrag zur Schonung der Umwelt.

Mix n' Match: Ab 2.000 Stück kann das Modell farblich kombiniert werden.

0-0183 RECY: Drehkugelschreiber mit gedeckt mattem Gehäuse und Clip aus 100% recyceltem Post-Consumer-Kunststoff.

Werbeschlüssel Schaft S, Clip T/HD/RD

The model is labelled with the recycling mark. Thanks to the European and ClimatePartner-certified production, the uma VANE RECY makes an additional sustainable contribution to the protection of the environment.

Mix n' Match: From 2,000 pieces, you can choose any colour combination.

0-0183 RECY: Twist ballpoint pen with opaque matt housing and clip made from 100% recycled post-consumer plastic.

Advertising code barrel S, clip T/HD/RD



ClimatePartner
zertifiziertes Produkt
climate-id.com/DIPVA4

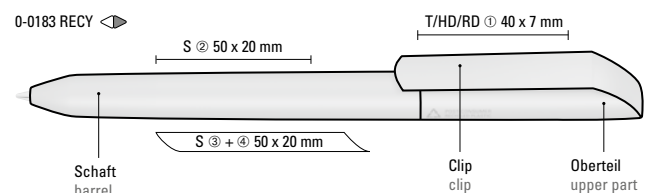

0-0071 RECY (● 8-0866)



Aufgrund der Besonderheit des Materials (Post-Consumer Recycled Plastic) sind produktionstechnische Farbschwankungen gegeben.

Due to the special nature of the material (post-consumer recycled plastic) colour variations may occur during the production process.

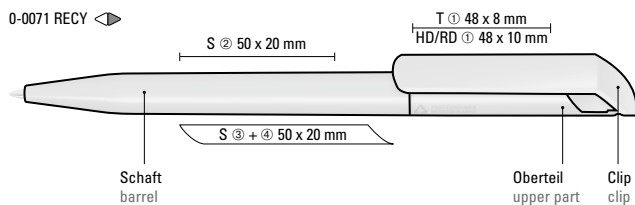

Das Modell ist mit dem Recyclingzeichen gekennzeichnet. Dank der europäischen und ClimatePartner-zertifizierten Produktion leistet der uma POP RECY einen zusätzlichen nachhaltigen Beitrag zur Schonung der Umwelt.

The model is labelled with the recycling mark. Thanks to the European and ClimatePartner-certified production, the uma POP RECY makes an additional sustainable contribution to the protection of the environment.

Mix n' Match: Ab 2.000 Stück kann das Modell farblich kombiniert werden.

Mix n' Match: From 2,000 pieces, you can choose any colour combination.

0-0071 RECY: Drehkugelschreiber mit gedeckt glänzendem Gehäuse aus 100% recyceltem Post-Consumer-Kunststoff. Werbeschlüssel Schaft S, Clip T/HD/RD

0-0071 RECY: Twist ballpoint pen with opaque glossy housing made from 100% recycled post-consumer plastic. Advertising code barrel S, clip T/HD/RD

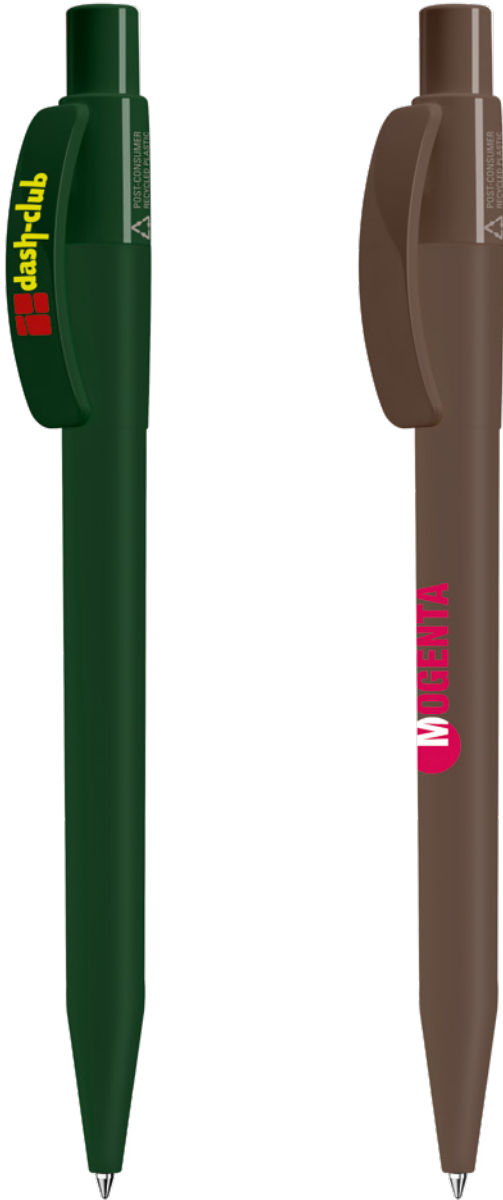

Drücker ABS
push-button ABS

- 32-2175
- 32-2147
- 32-0200
- 32-0348
- 32-0343
- 32-0002
- 32-0001
- 32-0468
- 32-0115
- 32-1585
- 32-0188

0-0017 RECY (● 8-0866)

- 32-0534
- 32-0350
- 32-0432
- 32-0425
- 32-0428
- 32-0001
- 32-0466
- 32-7532



0-0017 RECY:
Drücker sind ab 2.000 Stück auch
in allen glänzend gedeckten ABS
Standardfarben erhältlich.

0-0017 RECY:
From 2,000 units, plugs are
available in all solid shiny ABS
standard colours.

Aufgrund der Besonderheit des
Materials (Post-Consumer Recycled
Plastic) sind produktionstechnische
Farbschwankungen gegeben.

Due to the special nature of the
material (post-consumer recycled
plastic) colour variations may occur
during the production process.

Das Modell ist mit dem Recyclingzeichen gekennzeichnet. Dank der europäischen und ClimatePartner-zertifizierten Produktion leistet der uma PIXEL RECY einen zusätzlichen nachhaltigen Beitrag zur Schonung der Umwelt.

The model is labelled with the recycling mark. Thanks to the European and ClimatePartner-certified production, the uma PIXEL RECY makes an additional sustainable contribution to the protection of the environment.

Mix n' Match: Ab 2.000 Stück kann das Modell farblich kombiniert werden.

Mix n' Match: From 2,000 pieces, you can choose any colour combination.

0-0017 RECY: Druckkugelschreiber mit gedeckt mattem Kunststoffgehäuse aus 100% recyceltem Post-Consumer-Kunststoff, glänzendem Bogenclip und Drücker.

0-0017 RECY: Retractable ballpoint pen with matt plastic housing made from 100% recycled post-consumer plastic, opaque glossy curved clip and push-button.

Werbeschlüssel Schaft S ○, Clip T

Advertising code barrel S ○, clip T

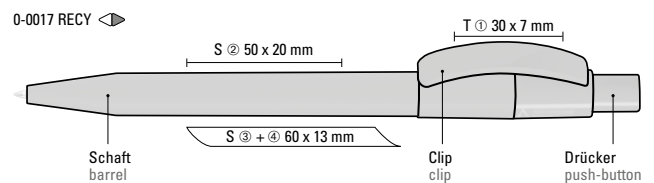



Aufgrund der Besonderheit des Materials (Post-Consumer Recycled Plastic) sind produktionstechnische Farbschwankungen gegeben.

Due to the special nature of the material (post-consumer recycled plastic) colour variations may occur during the production process.



umaBlackForest
Pens

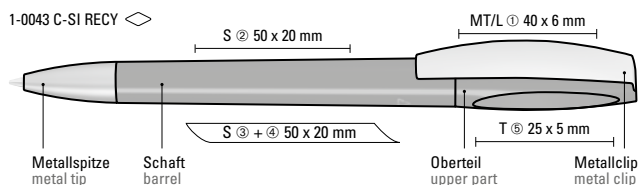
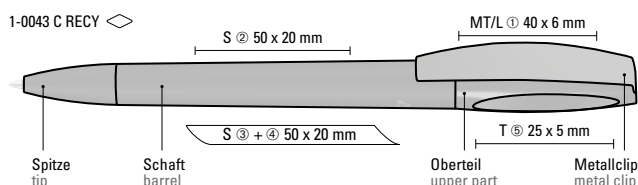

Das Modell ist mit dem Recyclingzeichen gekennzeichnet. Dank der ClimatePartner-zertifizierten Produktion leistet der uma CHILL C RECY einen zusätzlichen nachhaltigen Beitrag zur Schonung der Umwelt.

1-0043 C RECY: Drehkugelschreiber mit gedeckt mattem Gehäuse aus 100% recyceltem Post-Consumer-Kunststoff. Metallclip matt verchromt.

1-0043 C-SI RECY: Drehkugelschreiber mit gedeckt mattem Gehäuse aus 100% recyceltem Post-Consumer-Kunststoff. Metallclip und schwere Metallspitze matt verchromt.

Werbeschlüssel Schaft S O, Clip MT/L, Oberteil T

The model is labelled with the recycling mark. Thanks to the ClimatePartner-certified production, the uma CHILL C RECY makes an additional sustainable contribution to the protection of the environment.

1-0043 C RECY: Twist ballpoint pen with opaque mat housing made from 100% recycled post-consumer plastic. Metal clip matt chromed.

1-0043 C-SI RECY: Twist ballpoint pen with opaque mat housing made from 100% recycled post-consumer plastic. Metal clip and heavy metal tip matt chromed.

Advertising code barrel S O, clip MT/L, upper part T

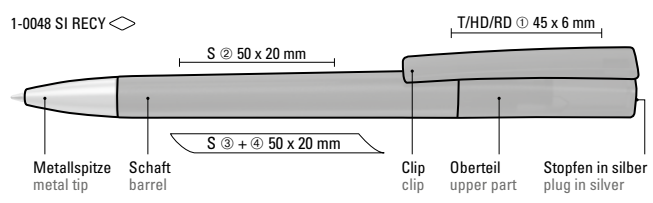

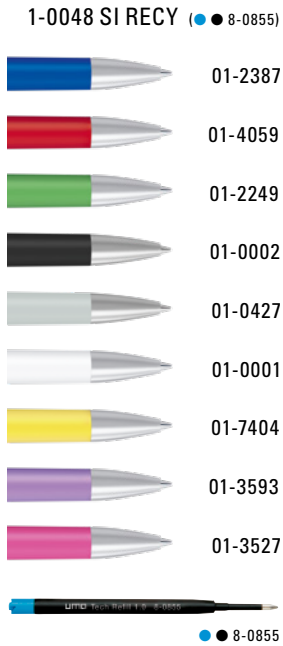
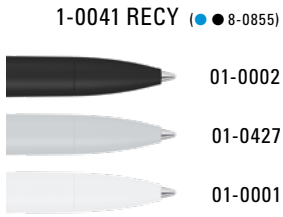

Aufgrund der Besonderheit des Materials (Post-Consumer Recycled Plastic) sind produktionstechnische Farbschwankungen gegeben.

Due to the special nature of the material (post-consumer recycled plastic) colour variations may occur during the production process.



umaBlackForest
Pens

Die Modelle sind mit dem Recyclingzeichen gekennzeichnet. Dank der ClimatePartner-zertifizierten Produktion leisten der uma CETA RECY und ULTIMATE SI RECY einen zusätzlichen nachhaltigen Beitrag zur Schonung der Umwelt.

The models are labelled with the recycling mark. Thanks to the ClimatePartner-certified production, the uma CETA RECY and ULTIMATE SI RECY makes an additional sustainable contribution to the protection of the environment.

1-0041 RECY: Drehkugelschreiber mit gedeckt mattem Gehäuse aus 100% recyceltem Post-Consumer-Kunststoff.

1-0041 RECY: Twist ballpoint pen with opaque matt housing made from 100% recycled post-consumer plastic.

1-0048 SI RECY: Drehkugelschreiber mit gedeckt mattem Gehäuse aus 100% recyceltem Post-Consumer-Kunststoff. Metallspitze matt verchromt. Stopfen optional in verschiedenen matt gedeckten Farben oder silber (Standard ABS) erhältlich.

1-0048 SI RECY: Twist ballpoint pen with opaque matt housing made from 100% recycled post-consumer plastic. Metal tip matt chromed. Plugs optionally available in various matt colours or silver (standard ABS).

Werbeschlüssel 1-0041 RECY
Schaft S ○, Clip T

Advertising code 1-0041 RECY
barrel S ○, clip T

Werbeschlüssel 1-0048 SI RECY
Schaft S ○, Clip T/HD/RD

Advertising code 1-0048 SI RECY
barrel S ○, clip T/HD/RD

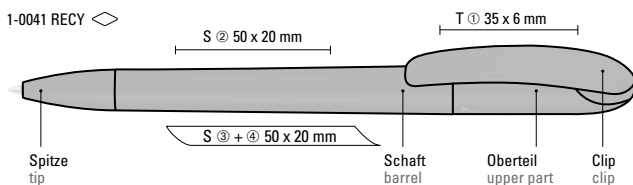



Holz

Für die una Schreibgeräte aus **Holz** wird ausschließlich PEFC- oder FSC®-zertifiziertes Holz verwendet. Durch spezielle Bearbeitung des nachwachsenden Rohstoffs transportiert das Naturprodukt Ihre Werbebotschaft edel und formschön zum Kunden. Der Naturstoff Holz variiert sowohl in der Farbigkeit des Holzes als auch in der Struktur (Maserung).

Wood

Only PEFC or FSC® certified **wood** is used for the una writing utensils made of wood. Through special processing of the sustainable raw material, the natural product transports its advertising message in a refined and beautiful design to the customer. Wood is a natural material with a great variety of colours and textures (grain effect).

Für dieses una Schreibgerät aus Holz wird FSC®-zertifiziertes Buchenholz verwendet.

Only FSC® certified beechwood is used for this una writing utensil made of wood.

ROOT
5-5700





Metall Recy – recyceltes Metall

Das recycelte **Metall** wird aus bereits vorhandenen Materialien gewonnen, was dazu beiträgt, den Verbrauch von neuen Ressourcen zu reduzieren und Abfälle zu minimieren. Durch die Verwendung von recycelten Materialien wird die Belastung der Umwelt verringert und Ressourcen geschont. Dank der ClimatePartner-zertifizierten Produktion leisten die uma Metall RECY Schreibgeräte einen zusätzlichen nachhaltigen Beitrag zur Schonung der Umwelt.

Metal Recy – recycled metal

The recycled **metal** is obtained from existing materials, which helps to reduce the consumption of new resources and minimise waste. By using recycled materials, the impact on the environment is reduced and resources are conserved. Thanks to the ClimatePartner-certified production, the uma metal RECY writing instruments makes an additional sustainable contribution to the protection of the environment.

Das Gehäuse des STRAIGHT GUM RECY wird aus recyceltem Metall hergestellt und ist mit dem METAL-RECY-Logo gekennzeichnet.

The housing of the STRAIGHT GUM RECY is made of recycled metal and is marked with the METAL RECY logo.

STRAIGHT GUM RECY
0-9450 GUM RECY



Aluminium Recy – recyceltes Aluminium

Recyceltes **Aluminium** wird aus bereits bestehenden Aluminiumprodukten gewonnen und hilft, den Bedarf an neuen Rohstoffen zu verringern. Diese Methode reduziert sowohl den Energieverbrauch als auch den CO₂-Ausstoß, da weniger Energie für die Herstellung erforderlich ist. Dank der ClimatePartner-zertifizierten Produktion leisten die uma Aluminium RECY Schreibgeräte einen zusätzlichen Beitrag zur Schonung der Umwelt.

Aluminium Recy – recycled aluminium

Recycled **aluminium** is obtained from existing aluminium products and helps to reduce the need for new raw materials. This method reduces both energy consumption and CO₂ emissions, as less energy is required for production. Thanks to ClimatePartner-certified production, uma aluminium RECY writing instruments make an additional sustainable contribution to the protection of the environment.

Das Gehäuse des LUMOS RECY wird aus recyceltem Aluminium hergestellt und ist mit dem rAL-Logo gekennzeichnet.

The housing of the LUMOS RECY is made of recycled metal and is marked with the rAL logo.

LUMOS RECY
0-9560 RECY



5-5700 (● 8-0855)



37-W001



● 8-0855



Das Modell eignet sich für eine Lasergravur.

The model is suitable for laser engraving.

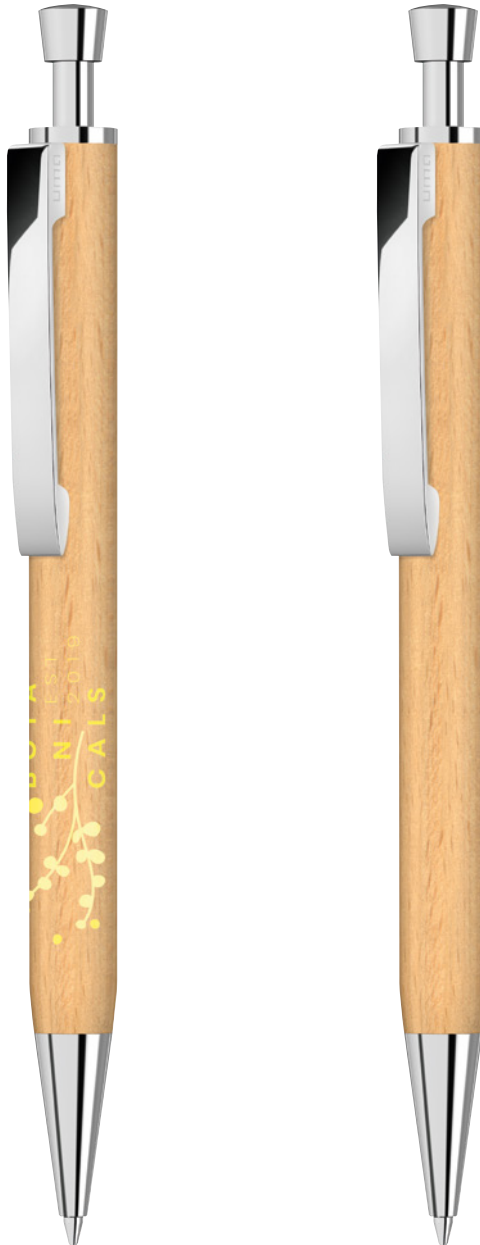

Für diese uma Schreibgeräte aus Holz wird FSC®-zertifiziertes Buchenholz verwendet. Durch spezielle Bearbeitung des nachwachsenden Rohstoffs transportiert das Naturprodukt Ihre Werbebotschaft edel und formschön zum Kunden. Der Naturstoff Holz variiert sowohl in der Farbigkeit des Holzes als auch in der Struktur (Maserung).

Only FSC® certified beechwood is used for these uma writing utensils made of wood. Through special processing of the sustainable raw material, the natural product transports its advertising message in a refined and beautiful design to the customer.

Wood is a natural material with a great variety of colours and textures (grain effect).



Dank der ClimatePartner-zertifizierten Produktion leistet der uma ROOT einen zusätzlichen nachhaltigen Beitrag zur Schonung der Umwelt.

Thanks to the ClimatePartner-certified production, the uma ROOT makes an additional sustainable contribution to the protection of the environment.

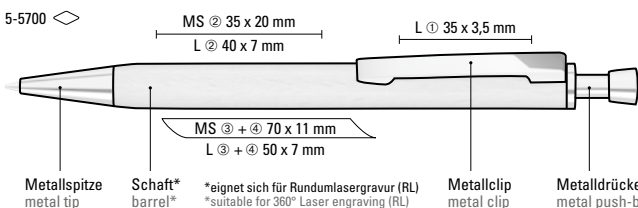

5-5700: Holz-Druckkugelschreiber mit Metalldrücker, Metallclip und Metallspitze glanzverchromt. Schaft aus schutzlackiertem FSC®-zertifiziertem Buchenholz.

5-5700: Wooden retractable ballpoint pen with metal push-button, metal clip and metal tip chrome plated. Barrel made from FSC® certified beechwood with protective varnish coating.

Werbeschlüssel Schaft MS/L/RL, Clip L

Advertising code barrel MS/L/RL, clip L

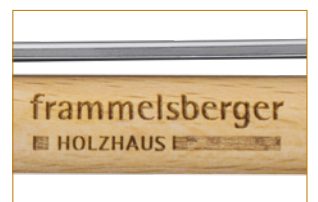

Die Modelle eignen sich für eine Lasergravur.

The models are suitable for laser engraving.

Farb-Code/Minen
Colour code/Refills

TREE
5-5400

LEAF
5-5900

5-5400 (● 8-0877)



5-5900 (● 8-0855)



Für diese uma Schreibgeräte aus Holz wird ausschließlich PEFC-zertifiziertes Buchenholz verwendet. Durch spezielle Bearbeitung des nachwachsenden Rohstoffs transportiert das Naturprodukt Ihre Werbebotschaft edel und formschön zum Kunden. Der Naturstoff Holz variiert sowohl in der Farbigkeit des Holzes, als auch in der Struktur (Maserung).

Only PEFC-certified beechwood is used for these uma writing utensils made of wood. Through special processing of the sustainable raw material, the natural product transports its advertising message in a refined and beautiful design to the customer.

Wood is a natural material with a great variety of colours and textures (grain effect).



Für diese uma Schreibgeräte aus Holz wird FSC®-zertifiziertes Buchenholz verwendet. Durch spezielle Bearbeitung des nachwachsenden Rohstoffs transportiert das Naturprodukt Ihre Werbebotschaft edel und formschön zum Kunden. Der Naturstoff Holz variiert sowohl in der Farbigkeit des Holzes, als auch in der Struktur (Maserung).

Only FSC® certified beechwood is used for these uma writing utensils made of wood. Through special processing of the sustainable raw material, the natural product transports its advertising message in a refined and beautiful design to the customer.

Wood is a natural material with a great variety of colours and textures (grain effect).

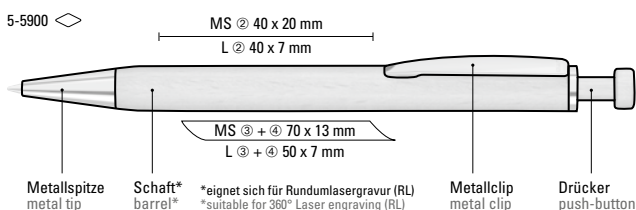
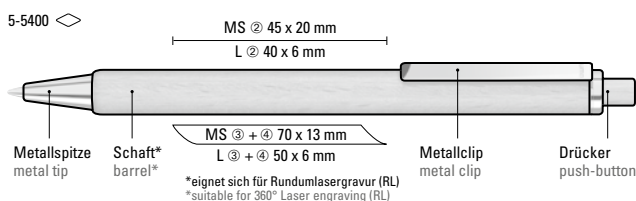

Dank der ClimatePartner-zertifizierten Produktion leisten der uma TREE und LEAF einen zusätzlichen nachhaltigen Beitrag zur Schonung der Umwelt.

5-5400: Holz-Druckkugelschreiber mit Holzdrücker, Metallclip und Metallspitze glanzverchromt. Schaft und Drücker aus schutzlackiertem PEFC-zertifiziertem Buchenholz.

5-5900: Holz-Druckkugelschreiber mit Holzdrücker, Metallclip und Metallspitze glanzverchromt. Schaft und Drücker aus schutzlackiertem FSC®-zertifiziertem Buchenholz.

Thanks to the ClimatePartner-certified production, the uma TREE and LEAF make an additional sustainable contribution to the protection of the environment.

5-5400: Wooden retractable ballpoint pen with wooden push-button, metal clip and metal tip chrome plated. Barrel and push-button made from PEFC-certified beechwood with protective varnish coating.

5-5900: Wooden retractable ballpoint pen with wooden push-button, metal clip and metal tip chrome plated. Barrel and push-button made from FSC® certified beechwood with protective varnish coating.

Werbeschlüssel

Schaft MS/L/RL

Advertising code

barrel MS/L/RL

WOODY
5-5600

WOODY B
5-5607 B

Farb-Code/Minen
Colour code/Refills



5-5600 (● 8-0855)
5-5607 B (0,7mm)

05-W001



● 8-0855



Für diese uma Schreibgeräte aus Holz wird ausschließlich PEFC-zertifiziertes Buchenholz verwendet. Durch spezielle Bearbeitung des nachwachsenden Rohstoffs transportiert das Naturprodukt Ihre Werbebotschaft edel und formschön zum Kunden.

Der Naturstoff Holz variiert sowohl in der Farbigkeit des Holzes als auch in der Struktur (Maserung).

Only PEFC-certified beechwood is used for these uma writing utensils made of wood. Through special processing of the sustainable raw material, the natural product transports its advertising message in a refined and beautiful design to the customer.

Wood is a natural material with a great variety of colours and textures (grain effect).



Die Modelle eignen sich für eine Lasergravur.

The models are suitable for laser engraving.

Dank der ClimatePartner-zertifizierten Produktion leistet der uma WOODY einen zusätzlichen nachhaltigen Beitrag zur Schonung der Umwelt.

Thanks to the ClimatePartner-certified production, the uma WOODY makes an additional sustainable contribution to the protection of the environment.

5-5600: Holz-Druckkugelschreiber mit Holz-Kugeldrucker, Metallclip und Metallspitze silber glänzend. Schaft und Drucker aus schutzlackiertem PEFC-zertifiziertem Buchenholz.

5-5600: Wooden retractable ballpoint pen with wooden ball-button, metal clip and metal tip silver glossy. Barrel and push-button made from PEFC certified beechwood with protective varnish coating.

5-5607 B: Holz-Druckbleistift (0,7mm) mit Holz-Kugeldrucker, Metallclip und Metallspitze silber glänzend. Schaft und Drucker aus schutzlackiertem PEFC-zertifiziertem Buchenholz.

5-5607 B: Wooden mechanical pencil (0.7mm) with wooden ball-button, metal clip and metal tip silver glossy. Barrel and push-button made from PEFC certified beechwood with protective varnish coating.

Werbeschlüssel

Schaft MS/L/RL

Advertising code

barrel MS/L/RL



ClimatePartner
zertifiziertes Produkt
climate-id.com/DIPVA4

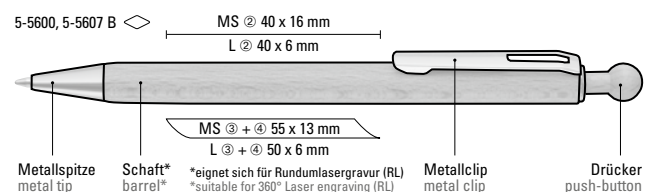

Farb-Code/Minen
Colour code/Refills

FOREST
5-5200

FOREST B
5-5207 B

BEECH
5-5800

5-5200 (● 8-0877)
5-5207 B (0,7mm)



05-W001



● 8-0877

5-5800 (● 8-0855)



08-W001



● 8-0855



Für diese uma Schreibgeräte aus Holz wird ausschließlich PEFC-zertifiziertes Buchenholz verwendet. Durch spezielle Bearbeitung des nachwachsenden Rohstoffs transportiert das Naturprodukt Ihre Werbebotschaft edel und formschön zum Kunden.

Der Naturstoff Holz variiert sowohl in der Farbigkeit des Holzes als auch in der Struktur (Maserung).

Only PEFC-certified beechwood is used for these uma writing utensils made of wood. Through special processing of the sustainable raw material, the natural product transports its advertising message in a refined and beautiful design to the customer.

Wood is a natural material with a great variety of colours and textures (grain effect).



Die Modelle eignen sich für eine Lasergravur.

The models are suitable for laser engraving.

Dank der ClimatePartner-zertifizierten Produktion leisten der uma FOREST und BEECH einen zusätzlichen nachhaltigen Beitrag zur Schonung der Umwelt.

Thanks to the ClimatePartner-certified production, the uma FOREST and BEECH make an additional sustainable contribution to the protection of the environment.



5-5200: Holz-Druckkugelschreiber mit Holzdrücker, Metallclip und Metallspitze silber glänzend. Schaft und Drücker aus schutzlackiertem PEFC-zertifiziertem Buchenholz.

5-5200: Wooden retractable ballpoint pen with wooden push-button, metal clip and metal tip silver glossy. Barrel and push-button made from PEFC certified beechwood with protective varnish coating.

5-5207 B: Holz-Druckbleistift (0,7mm) mit Holzdrücker, Metallclip und Metallspitze silber glänzend. Schaft und Drücker aus schutzlackiertem PEFC-zertifiziertem Buchenholz.

5-5207 B: Wooden mechanical pencil (0.7mm) with wooden push-button, metal clip and metal tip silver glossy. Barrel and push-button made from PEFC certified beechwood with protective varnish coating.

5-5800: Holz-Druckkugelschreiber mit Holzdrücker, Metallclip und Metallspitze glanzverchromt. Schaft und Drücker aus schutzlackiertem PEFC-zertifiziertem Buchenholz.

5-5800: Wooden retractable ballpoint pen with wooden push-button, metal clip and metal tip chrome plated. Barrel and push-button made from PEFC certified beechwood with protective varnish coating.

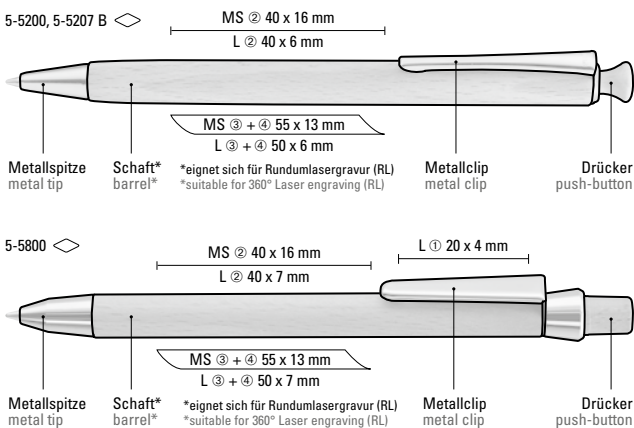

Werbeschlüssel 5-5200 Schaft MS/L/RL
Werbeschlüssel 5-5207 B

Advertising code 5-5200 barrel MS/L/RL
Advertising code 5-5207 B

Schaft MS/L/RL

barrel MS/L/RL

Werbeschlüssel 5-5800

Advertising code 5-5800

Schaft MS/L/RL, Clip L

barrel MS/L/RL, clip L



0-9370 (● 8-0888)
0-9372 R (● 8-0806)

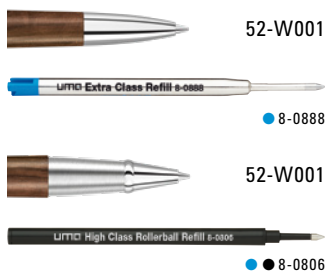

Für diese uma Schreibgeräte aus Holz wird FSC®-zertifiziertes Walnussholz verwendet. Durch spezielle Bearbeitung des nachwachsenden Rohstoffs transportiert das Naturprodukt Ihre Werbebotschaft edel und formschön zum Kunden. Der Naturstoff Holz variiert sowohl in der Farbigkeit des Holzes, als auch in der Struktur (Maserung).

Only FSC® certified walnut wood is used for these uma writing utensils made of wood. Through special processing of the sustainable raw material, the natural product transports its advertising message in a refined and beautiful design to the customer. Wood is a natural material with a great variety of colours and textures (grain effect).

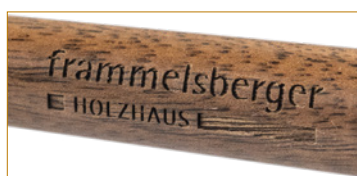

Die Modelle eignen sich für eine Lasergravur.

The models are suitable for laser engraving.



Die Modelle eignen sich für eine Lasergravur in beige.

The models are suitable for laser engraving in beige.



Etui Empfehlung / Case suggestion

ETUI 0-0944

Beschreibung auf Seite 287

See description on page 287

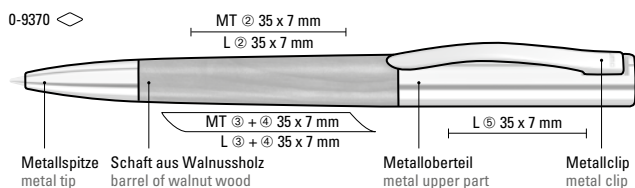

0-9370: Metall-Drehkugelschreiber mit Schaft aus FSC®-zertifiziertem Walnussholz, Softdrehmechanik und gefedertem Clip. Oberteil, Clip und Spitze glanzverchromt.

0-9370: Metal twist ballpoint pen with barrel made from FSC® certified walnut wood, soft twist mechanism and spring-mounted clip. Upper part, clip and tip glossy chrome plated.

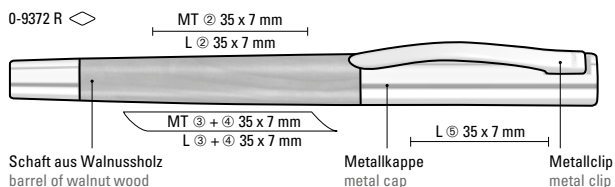

0-9372 R: Metall-Rollerball mit Schaft aus FSC®-zertifiziertem Walnussholz und gefedertem Clip. Kappe und Clip glanzverchromt.

0-9372 R: Metal roller ball with barrel made from FSC® certified walnut wood, spring-mounted clip. Cap and clip glossy chrome plated.

Werbeschlüssel 0-9370 Schaft MT/L, Oberteil L

Advertising code 0-9370 barrel MT/L, upper part L

Werbeschlüssel 0-9372 R Schaft MT/L, Kappe L

Advertising code 0-9372 R barrel MT/L, cap L



0-9190 WOOD (● 8-0888)



Für diese uma Schreibgeräte aus Holz wird FSC®-zertifiziertes Walnussholz verwendet. Durch spezielle Bearbeitung des nachwachsenden Rohstoffs transportiert das Naturprodukt Ihre Werbebotschaft edel und formschön zum Kunden.

Der Naturstoff Holz variiert sowohl in der Farbigkeit des Holzes, als auch in der Struktur (Maserung).

Only FSC® certified walnut wood is used for these uma writing utensils made of wood. Through special processing of the sustainable raw material, the natural product transports its advertising message in a refined and beautiful design to the customer. Wood is a natural material with a great variety of colours and textures (grain effect).



Das Modell eignet sich für eine Lasergravur.
The model is suitable for laser engraving.



0-9190 WOOD ◊

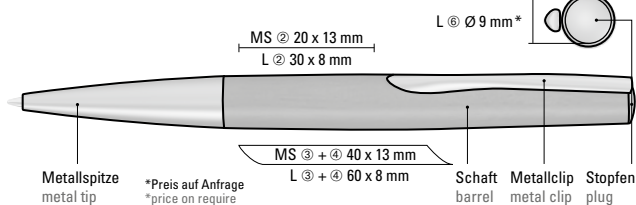

0-9190 WOOD: Metall-Drehkugelschreiber mit Schaft aus FSC®-zertifiziertem Walnussholz, gefederter Metallclip, Metallstopfen, schwere Metallspitze matt verchromt und Softdrehmechanik.

0-9190 WOOD: Metal twist ballpoint pen with barrel made from FSC® certified walnut wood, spring-mounted metal clip, plug, metal tip matt chrome plated and soft twist mechanism.

Werbeschlüssel Schaft MS/L, Stopfen L

Advertising code barrel MS/L, plug L





*06-7527 BIO-MIX: Drücker und Spitze sind aus Bio-Material gefertigt. Der Werkstoff Celluloseacetat entspricht der DIN EN 13432:2000-12 und wird aus europäischen Weichhölzern gewonnen.

*06-7527 BIO-MIX: Push-button and tip are made of bio material. This material – cellulose acetate – complies with DIN EN 13432:2000-12 and is derived from European softwoods.

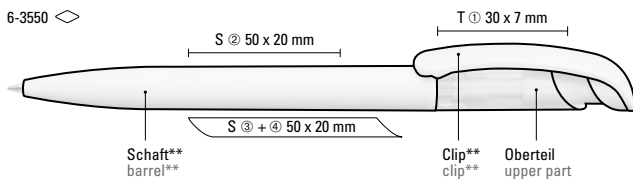

**Die Herstellung der Clips und der Schäfte ist aufgrund des besonderen Materials produktionstechnischen Schwankungen unterlegen. Leichte Unterschiede in der Farbe und der Oberfläche (Schlierenbildung) sind möglich.

**The production of the clips and barrels is subject to fluctuations due to the special material. Slight differences in colour and surface (smear formation) are possible.

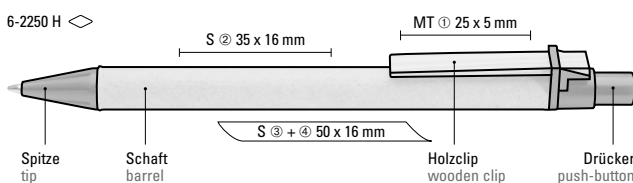

6-3550: Druckkugelschreiber mit Gehäuse und Clip aus 100% nachwachsendem und kompostierbarem Material. Oberteil aus gefrostetem ABS Kunststoff.

6-2250 H: Druckkugelschreiber aus recycelter, naturfarbener Pappe. Spitze und Drücker unifarben aus recyceltem oder biologisch abbaubarem Kunststoff sowie (*06-7527 Bio-Mix) Holzclip.

6-3550: Retractable ballpoint pen with barrel and clip made from 100% renewable biodegradable material. Upper part made from transparent frosted ABS plastic.

6-2250 H: Retractable ballpoint pen made from recycled, natural-coloured cardboard. Tip and push-button uni-coloured made from recycled or biodegradable plastic as well as wooden clip.

Werbeschlüssel 6-3550 Schaft S ◊, Clip T
Werbeschlüssel 6-2250 H Schaft S, Clip MT

Advertising code 6-3550 barrel S ◊, clip T
Advertising code 6-2550 H barrel S, clip MT



0-9450 GUM RECY (● 8-0855)



58-0002

0-9450 M GUM RECY (● 8-0855)



58-0002



(● 8-0855)



Die Modelle eignen sich für eine Lasergravur in gold. Siehe Seite 305.

The models are suitable for laser engraving in gold. See page 305.

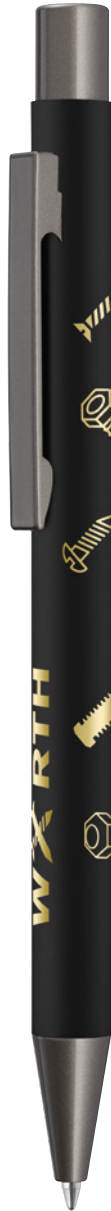

Die Modelle sind mit dem Recyclingzeichen gekennzeichnet. Dank der ClimatePartner-zertifizierten Produktion leistet der uma STRAIGHT GUM RECY einen zusätzlichen nachhaltigen Beitrag zur Schonung der Umwelt.

The models are labelled with the recycling mark. Thanks to the ClimatePartner-certified production, the uma STRAIGHT GUM RECY makes an additional sustainable contribution to the protection of the environment.

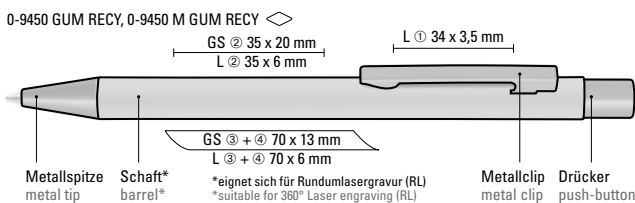

0-9450 GUM RECY: Metall-Druckkugelschreiber mit Softtouch-Gehäuse aus recyceltem Metall. Metallclip, Metallspitze und Drücker GUN metallic.

0-9450 GUM RECY: Metal retractable ballpoint pen with softtouch housing made from recycled metal. Metal clip, metal tip and push-button GUN metallic.

0-9450 M GUM RECY: Metall-Druckkugelschreiber mit Softtouch-Gehäuse aus recyceltem Metall. Metallclip, Metallspitze und Drücker schwarz glänzend.

0-9450 M GUM RECY: Metal retractable ballpoint pen with softtouch housing made from recycled metal. Metal clip, metal tip and push-button glossy black.

Werbeschlüssel Schaft GS/L/RL, Clip L

Advertising code barrel GS/L/RL, clip L



0-9560 RECY (● 8-0855)



Das Modell eignet sich für eine Lasergravur in weiß. Siehe Seite 305.

The model is suitable for laser engraving in white. See page 305.



Das Modell ist mit dem Recyclingzeichen gekennzeichnet. Dank der ClimatePartner-zertifizierten Produktion leistet der uma LUMOS RECY einen zusätzlichen nachhaltigen Beitrag zur Schonung der Umwelt.

The model is labelled with the recycling mark. Thanks to the ClimatePartner-certified production, the uma LUMOS RECY makes an additional sustainable contribution to the protection of the environment.

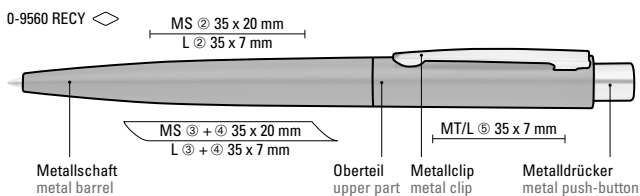

0-9560 RECY: Metall-Druckkugelschreiber mit matt lackiertem Gehäuse aus recyceltem Aluminium. Metallclip und Drücker glanzverchromt.

0-9560 RECY: Metal retractable ballpoint pen with matt lacquered housing made from recycled aluminium. Metal clip and push-button chrome plated.

Werbeschlüssel

Schaft MS/L
Oberteil MT/L

Advertising code

barrel MS/L
upper part MT/L



Das Modell ist mit dem Recyclingzeichen gekennzeichnet. Dank der ClimatePartner-zertifizierten Produktion leistet der uma GROOVE RECY einen zusätzlichen nachhaltigen Beitrag zur Schonung der Umwelt. Die Modelle eignen sich für eine Lasergravur in weiß. Siehe Seite 305.

The model is labelled with the recycling mark. Thanks to the ClimatePartner-certified production, the uma GROOVE RECY makes an additional sustainable contribution to the protection of the environment. The models are suitable for laser engraving in white. See page 305.

0-9530 RECY (● 8-0855)
0-9530 TO RECY (● 8-0855)



0-9530 M RECY (● 8-0855)



UMA
PRIME



0-9530 RECY, 0-9530 M RECY ◊

MS ⌀ 45 x 20 mm
L ⌀ 50 x 6 mm

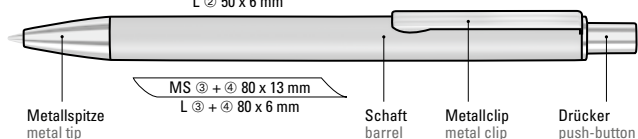

MS ⓐ + ⓑ 80 x 13 mm
L ⓐ + ⓑ 80 x 6 mm

0-9530 TO RECY ◊

MS ⌀ 45 x 20 mm
L ⌀ 50 x 6 mm

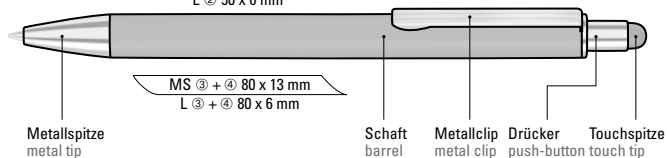

MS ⓐ + ⓑ 80 x 13 mm
L ⓐ + ⓑ 80 x 6 mm

0-9530 RECY: Metall-Druckkugelschreiber mit matter Oberfläche aus recyceltem Aluminium. Metallclip mit eingelassenen Rillen, Metallspitze und Drücker in silber glänzend.

0-9530 M RECY: Metall-Druckkugelschreiber mit matter Oberfläche aus recyceltem Aluminium. Metallclip mit eingelassenen Rillen, Metallspitze und Drücker in schwarz matt.

0-9530 TO RECY: Metall-Druckkugelschreiber mit matter Oberfläche aus recyceltem Aluminium. Metallclip mit eingelassenen Rillen, Metallspitze in silber glänzend und Drücker mit integrierter Touchscreensteuerung.

0-9530 RECY: Metal retractable ballpoint pen with matt finish made from recycled aluminium. Metal clip with recessed grooves, metal tip and push-button in glossy silver.

0-9530 M RECY: Metal retractable ballpoint pen with matt finish made from recycled aluminium. Metal clip with recessed grooves, metal tip and push-button in matt black.

0-9530 TO RECY: Metal retractable ballpoint pen with matt finish made from recycled aluminium. Metal clip with recessed grooves, metal tip in glossy silver and push-button with integrated touch screen control.

Werbeschlüssel

Schaft MS/L

Advertising code

barrel MS/L

STOFF KUNSTSTOFF KUNSTSTOFF KUNSTSTOFF
PLASTIC PLASTIC PLASTIC PLASTIC PL



STSTOFF **KUNSTSTOFF** KUN
L-ASTIC **PLASTIC** PLASTIC P





Pastellfarben **new!**
Pastel colours

0-0133 KT GUM (● 8-0855)	
0-0133 KT-SI GUM (● 8-0855)	
	50-2925
	50-2388
	50-7687
	58-9441* new!
	50-7627
	50-2420
	50-0347
	58-9521* new!
	50-0002
	50-0429
	58-9140* new!
	50-0101
	50-0266
	58-9361* new!
	58-9321* new!
	50-2039
	50-0130
	50-1665
	50-0326
	● 8-0855



UMQ PRIME



UMQ PRIME



* Farbe nicht für 0-0133 KT-SI GUM erhältlich
Colour not available for 0-0133 KT-SI GUM

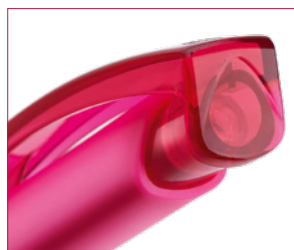

Die Modelle eignen sich für NFC-Technik.
The models are suitable for NFC technology.



0-0133 KT GUM, 0-0133 KT-SI GUM* ◊

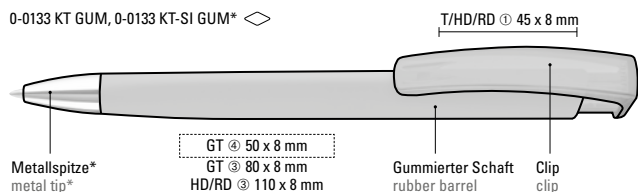

0-0133 KT GUM: Druckkugelschreiber mit gummiertem Dreieckgehäuse und transparent glänzendem Clip.

0-0133 KT-SI GUM: Druckkugelschreiber mit gummiertem Dreieckgehäuse, transparent glänzendem Clip und schwerer Metallspitze glanzverchromt.

Werbeschlüssel

Schaft GT/HD/RD,
Clip T/HD/RD

0-0133 KT GUM: Retractable ballpoint pen with softtouch triangular housing and transparent glossy clip.

0-0133 KT-SI GUM: Retractable ballpoint pen with softtouch triangular housing, transparent glossy clip and heavy metal tip chrome plated.

Advertising code

barrel GT/HD/RD,
clip T/HD/RD



C NFC NFC NFC NFC NFC NFC



NFC NFC NFC **NFC** NFC NF
C NFC NFC NFC NFC NFC

Verbinden Sie analoges Schreiben und Werben mittels NFC-Technik mit der interaktiven Welt. Transportieren Sie mit den integrierten NFC TAGS nicht mehr nur haptische Werbung, sondern digitale Informationen. Egal ob Kontaktdaten, BusinessCard, Videobotschaften, Produkt- oder Imagefilme, Webseiten oder Social Media Seiten, Verkaufsunterlagen wie Produktkataloge u.v.m.

Connect analogue writing and advertising with the interactive world using NFC technology. With the integrated NFC TAGS, go beyond haptic advertising and transmit digital information. Perfect for contact details, BusinessCards, video messages, product or image films, website or social media pages, sales documentation such as product catalogues, etc.



TRINITY GUM
0-0133 GUM

TRINITY SI GUM
0-0133 SI GUM

TRINITY KG SI GUM
0-0133 KG-SI GUM

Farb-Code/Minen
Colour code/Refills

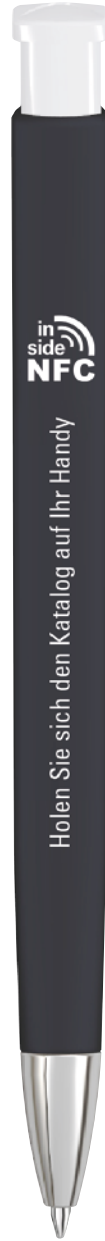

0-0133 GUM (● 8-0855)
0-0133 SI GUM (● 8-0855)

50-0002



0-0133 KG-SI GUM (● 8-0855)

50-2925



50-2388



50-7687



50-7627



50-2420



50-0347



50-0002



50-0429



50-0101



50-0266



50-2039



50-0130



50-1665



50-0326



● 8-0855



Die Modelle eignen sich für NFC-Technik.
The models are suitable for NFC technology.



0-0133 GUM: Druckkugelschreiber mit gummiertem Dreikantgehäuse und gedeckt glänzendem Clip.

0-0133 SI GUM: Druckkugelschreiber mit gummiertem Dreikantgehäuse, gedeckt glänzendem Clip und schwerer Metallspitze glanzverchromt.

0-0133 KG-SI GUM: Druckkugelschreiber mit gummiertem Dreikantgehäuse, weiß gedeckt glänzendem Clip und schwerer Metallspitze glanzverchromt.

Werbeschlüssel Schaft GT/HD/RD, Clip T/HD/RD

0-0133 GUM: Retractable ballpoint pen with softtouch triangular housing and opaque glossy clip.

0-0133 SI GUM: Retractable ballpoint pen with softtouch triangular housing, opaque glossy clip and heavy metal tip chrome plated.

0-0133 KG-SI GUM: Retractable ballpoint pen with softtouch triangular housing, opaque glossy clip in white and heavy metal tip chrome plated.

Advertising code barrel GT/HD/RD, clip T/HD/RD



0-0133 GUM, 0-0133 SI GUM*, 0-0133 KG-SI GUM* ◊

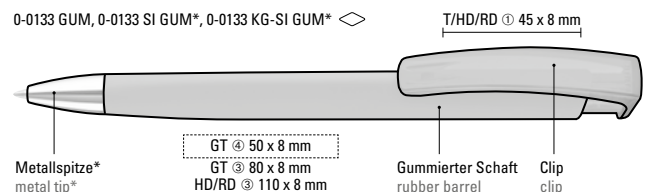

Metallspitze*
metal tip*

GT 50 x 8 mm
GT 80 x 8 mm
HD/RD 110 x 8 mm

Gummierter Schaft
rubber barrel

Clip
clip

0-0133 (● 8-0855)
0-0133 SI (● 8-0855)



0-0133 T-SI (● 8-0856)

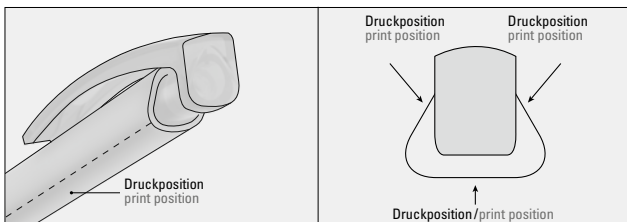

Die Modelle eignen sich für NFC-Technik.
The models are suitable for NFC technology.



0-0133, 0-0133 SI*, 0-0133 T-SI* ◊

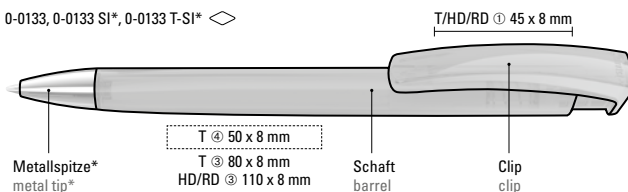

0-0133: Druckkugelschreiber mit gedeckt glänzendem Dreikantgehäuse.

0-0133 SI: Druckkugelschreiber mit gedeckt glänzendem Dreikantgehäuse und schwerer Metallspitze glanzverchromt.

0-0133 T-SI: Druckkugelschreiber mit transparent glänzendem Dreikantgehäuse und schwerer Metallspitze glanzverchromt.

0-0133: Retractable ballpoint pen with opaque glossy triangular housing.

0-0133 SI: Retractable ballpoint pen with opaque glossy triangular housing and heavy metal tip chrome plated.

0-0133 T-SI: Retractable ballpoint pen with transparent triangular housing and heavy metal tip chrome plated.

Werbeschlüssel

Schaft T/HD/RD,
Clip T/HD/RD

Advertising code

barrel T/HD/RD,
clip T/HD/RD



0-0125 M GUM (● 8-0855)
0-0125 M-SI GUM (● 8-0855)
0-0125 GUM (● 8-0855)



● 8-0855



UMA
PRIME

UMA
PRIME

0-0125 M GUM ◊

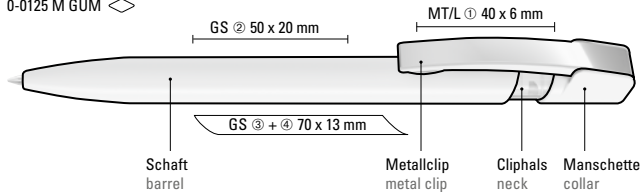

0-0125 M-SI GUM ◊

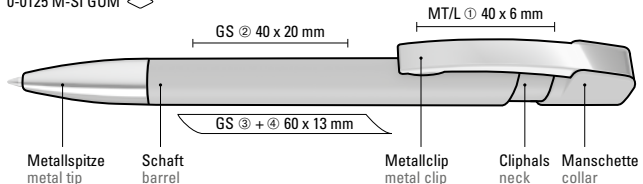

0-0125 GUM ◊

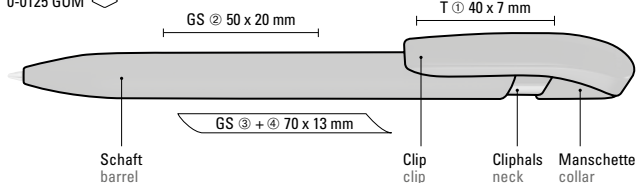

0-0125 M GUM: Druckkugelschreiber mit Softtouch-Gehäuse und flexiblem Metallclip.

0-0125 M-SI GUM: Druckkugelschreiber mit Softtouch-Gehäuse, flexiblem Metallclip und schwerer Metallspitze glanzverchromt.

0-0125 GUM: Druckkugelschreiber mit Softtouch-Gehäuse und Manschette, Clip und Cliphals gedeckt glänzend.

Werbeschlüssel 0-0125 M GUM
Schaft GS, Clip MT/L

Werbeschlüssel 0-0125 M-SI GUM
Schaft GS, Clip MT/L

Werbeschlüssel 0-0125 GUM
Schaft GS, Clip T

0-0125 M GUM: Retractable ballpoint pen with softtouch housing and flexible metal clip.

0-0125 M-SI GUM: Retractable ballpoint pen with softtouch housing, flexible metal clip and heavy metal tip chrome plated.

0-0125 GUM: Retractable ballpoint pen with softtouch housing and collar, opaque glossy clip and neck.

Advertising code 0-0125 M GUM
barrel GS, clip MT/L

Advertising code 0-0125 M-SI GUM
barrel GS, clip MT/L

Advertising code 0-0125 GUM
barrel GS, clip T

SKY
0-0125SKY M
0-0125 MSKY M SI
0-0125 M-SIFarb-Code/Minen
Colour code/RefillsUMA
PRIMEUMA
PRIME

0-0125 (● 8-0855)

0-0125 M (● 8-0855)

50-0002

50-0001

50-0072

50-1795

50-2271

50-0356

50-0405

50-0396

50-2077

50-0130

50-0214

50-1585

0-0125 M-SI (● 8-0855)

50-0002

50-0001

● 8-0855



0-0125: Druckkugelschreiber mit gedeckt glänzendem Gehäuse in uni weiß oder schwarz und farbig transparent glänzende Manschette.

0-0125 M: Druckkugelschreiber mit gedeckt glänzendem Gehäuse in uni weiß oder schwarz und farbig transparent glänzendem Cliphals, flexiblem Metallclip glanzverchromt.

0-0125 M-SI: Druckkugelschreiber mit gedeckt glänzendem Gehäuse in uni weiß oder schwarz, flexiblem Metallclip und schwerer Metallspitze glanzverchromt.

Werbeschlüssel 0-0125 Schaft S, Clip T

Werbeschlüssel 0-0125 M Schaft S, Clip MT/L

Werbeschlüssel 0-0125 M-SI Schaft S, Clip MT/L

0-0125: Retractable ballpoint pen with opaque glossy housing in white or black and transparent coloured collar.

0-0125 M: Retractable ballpoint pen with opaque glossy housing in white or black and transparent coloured collar, flexible metal clip chrome plated.

0-0125 M-SI: Retractable ballpoint pen with opaque glossy housing in white or black, flexible metal clip and heavy metal tip chrome plated.

Advertising code 0-0125 barrel S, clip T

Advertising code 0-0125 M barrel S, clip MT/L

Advertising code 0-0125 M-SI barrel S, clip MT/L

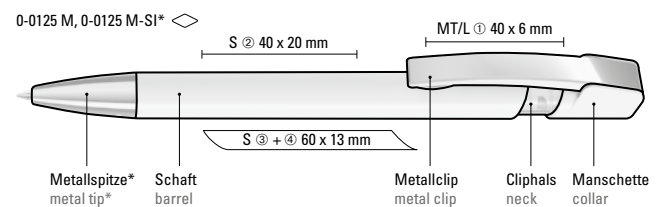
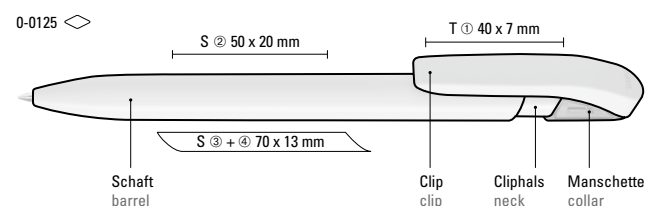

0-0125 TM (● 8-0856)
0-0125 TM-SI (● 8-0856)

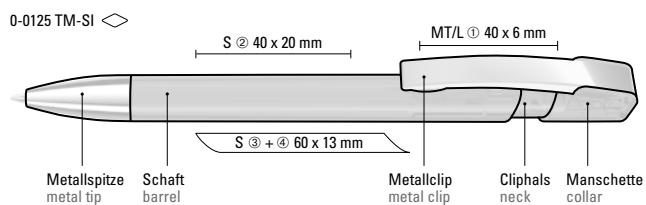
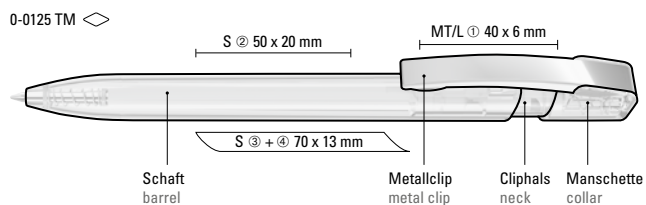
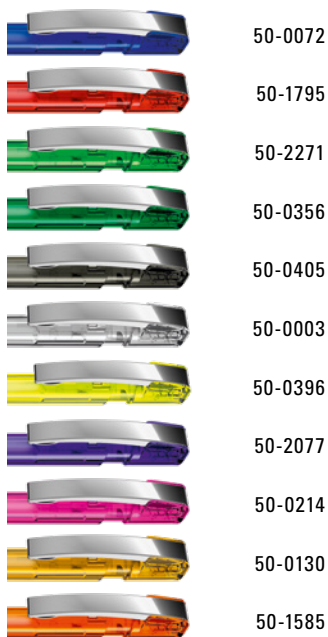

0-0125 TM: Druckkugelschreiber mit transparent glänzendem Gehäuse und flexiblem Metallclip glanzverchromt.

0-0125 TM-SI: Druckkugelschreiber mit transparent glänzendem Gehäuse, flexiblem Metallclip und schwerer Metallspitze glanzverchromt.

Werbeschlüssel Schaft S, Clip MT/L

0-0125 TM: Retractable ballpoint pen with transparent glossy housing and flexible metal clip chrome plated.

0-0125 TM-SI: Retractable ballpoint pen with transparent glossy housing, flexible metal clip and heavy metal tip chrome plated.

Advertising code barrel S, clip MT/L



ON!
UMC

GUN
N! C

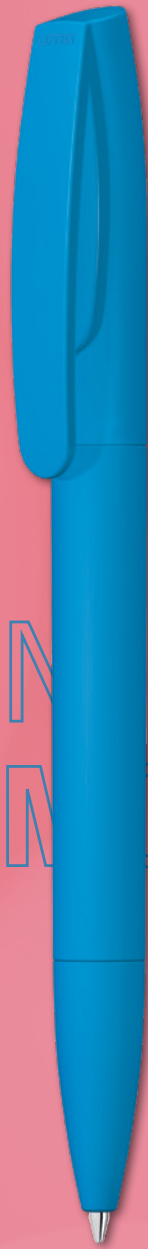

GUMON! GUMON! **GUMON!** GUMON!
GUMON! GUMON! GUMON! GUMON!



TRINITY KT-SI GUM
siehe Seite 102-107
see page 102-107



CORAL GUM
siehe Seite 116-117
see page 116-117



SKY M-SI GUM
siehe Seite 109
see page 109

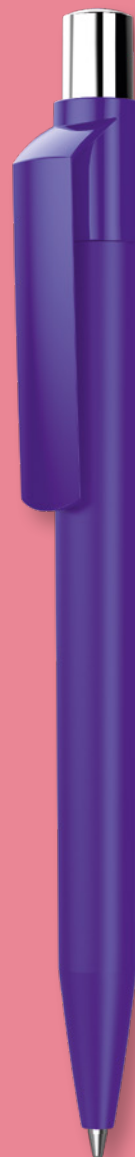

ON TOP GUM
siehe Seite 191
see page 191



VANE GUM
siehe Seite 192-193
see page 192-193

GUMON !

Wenn Schreibgeräte nicht nur spitze aussehen, sondern sich auch noch richtig gut anfühlen – dann halten Sie eines unserer GUM-Modelle in der Hand.



BRIGHT GUM
siehe Seite 234-235
see page 234-235



PYRA GUM
siehe Seite 244-245
see page 244-245



STRAIGHT GUM
siehe Seite 239-243
see page 239-243



BRUSH GUM
siehe Seite 234
see page 234



VIP GUM
siehe Seite 216
see page 216



MOOD GUM
siehe Seite 210
see page 210

GUMON !

*When a writing instrument not only looks great but also feels great,
then you are holding one of our GUM models in your hand.*



0-0177 GUM (● 8-0855)

	50-2925
	50-2388
	50-7687
	50-7627
	50-2420
	50-0347
	50-0002
	50-0429
	50-0101
	50-0266
	50-2039
	50-0130
	50-1585
	50-0326
	● 8-0855



0-0177 GUM ◊

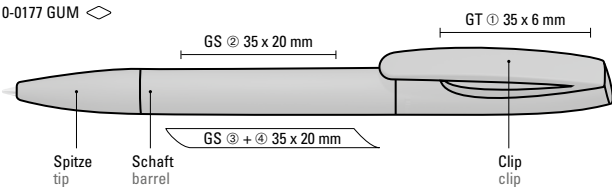

0-0177 GUM: Drehkugelschreiber mit Softtouch-Gehäuse und Softtouch-Clip.















Werbeschlüssel Schaft GS, Clip GT

0-0177 GUM: Twist ballpoint pen with softtouch housing and softtouch clip.

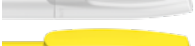
Advertising code barrel GS, clip GT



0-0177 SI (● 8-0855)
0-0177 (● 8-0855)

-  50-2925
-  50-0301
-  50-0280
-  50-7621
-  50-2420
-  50-0340
-  50-0002
-  50-CG08
-  50-0001
-  50-0115
-  50-2597
-  50-0233
-  50-1585
-  50-0326

 8-0855

0-0177 TF-SI (● 8-0856)
0-0177 TF (● 8-0856)

-  50-2925
-  50-0072
-  50-1795
-  50-2271
-  50-0356
-  50-0405
-  50-0003
-  50-0396
-  50-2077
-  50-0214
-  50-0130
-  50-1585
-  50-0326

 8-0856

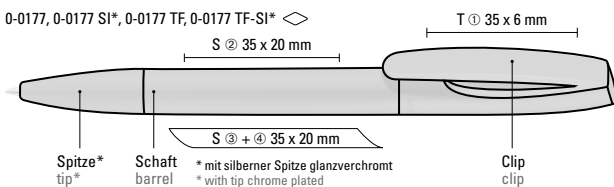

0-0177 SI: Drehkugelschreiber mit matt gedecktem Gehäuse und silberner Spitze glanzverchromt.

0-0177 TF-SI: Drehkugelschreiber mit transparent gefrostetem Gehäuse und silberner Spitze glanzverchromt.

0-0177: Drehkugelschreiber mit matt gedecktem Gehäuse.

0-0177 TF: Drehkugelschreiber mit transparent gefrostetem Gehäuse.

Werbeschlüssel

Schaft S, Clip T

0-0177 SI: Twist ballpoint pen with opaque matt housing and tip chrome plated.

0-0177 TF-SI: Twist ballpoint pen with transparent frosted housing and tip chrome plated.

0-0177: Twist ballpoint pen with opaque matt housing.

0-0177 TF: Twist ballpoint pen with transparent frosted housing.

Advertising code

barrel S, clip T



0-0151 (● 8-0855)

0-0151 M-SI (● 8-0855)



50-0002



50-0001



50-2925



50-0301



50-0280



50-7621



50-2420



50-0340



50-0002



50-CG08



50-0001



50-0115



50-2597



50-0233



50-0137



50-1665



50-0326

0-0151: Farben Drücker
0-0151: push-button colours



50-2925



50-0301



50-0280



50-7621



50-2420



50-0340



50-0002



50-CG08



50-0001



50-0115



50-2597



50-0233



50-0137



50-1665



50-0326



● 8-0855



0-0151 ◊

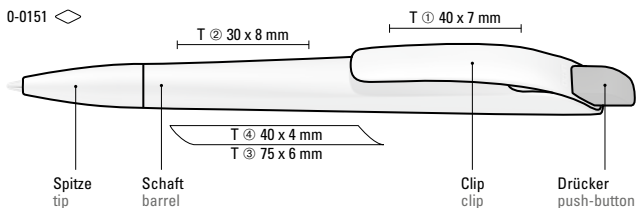

0-0151 M-SI ◊

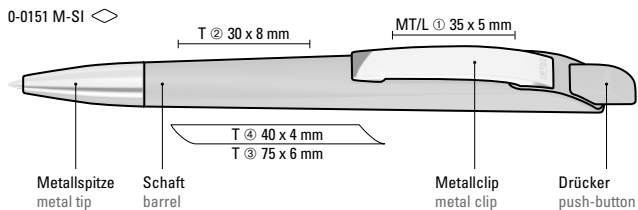

0-0151: Druckkugelschreiber mit geometrisch wechselnder Schaftform. Gehäuse gedeckt matt schwarz oder weiß mit Bogenclip und farbigem Drücker.

0-0151 M-SI: Druckkugelschreiber mit geometrisch wechselnder Schaftform. Gehäuse und Drücker gedeckt matt, Metallclip und Metallspitze glanzverchromt.

Werbeschlüssel 0-0151 Schaft T, Clip T
Werbeschlüssel 0-0151 M-SI Schaft T, Clip MT/L

0-0151: Retractable ballpoint pen with geometric changes in the barrel. Opaque matt housing in black or white with curved clip and coloured push-button.

0-0151 M-SI: Retractable ballpoint pen with geometric changes in the barrel. Opaque matt housing and push-button, metal clip and metal tip chrome plated.

Advertising code 0-0151 barrel T, clip T
Advertising code 0-0151 M-SI barrel T, clip MT/L



uma Quick Response

Verbinden Sie schnell die haptische, analoge Werbung mit der digitalen Welt. Mittels einem einfachen **uma QR-Code Print** können Sie mit den uma Schreibgeräten einen zusätzlichen Kommunikationskanal öffnen. Über den **QR-Code Scan** gelangen die User schnell auf eine vom Kunden definierte Landingpage. So wird schnelle und messbare Response geschaffen, die durch das Schreibgerät angetrieben wird.

Der **uma QR-Code Print** kann auf verschiedenen Modellen in verschiedenen Positionen und auch mittels verschiedener Drucktechniken bis hin zur Lasertechnik umgesetzt werden.

It's never been easier to connect haptic, analogue marketing to the digital world. All made possible thanks to a simple, **uma QR-Code Print**. Gain a new communication channel with your uma pens. Users just need to scan the **QR** code to quickly access the defined landing page. Achieve quick and measurable responses driven by pens.

uma QR codes can be printed in a range of positions on various models using several available printing methods, including laser technology.



QR-CODE QR-CODE QR-CODE QR-CODE QR-CODE QR-CODE QR-CODE QR-CODE QR-CODE QR-CODE























UMA
QR-Code Print
for Quick Response



Pastellfarben **new!**
Pastel colours

0-0154 SI (● 8-0855)

0-0154 TF-SI (● 8-0856)

-  50-2925
 -  50-0301
 -  50-0280
 -  50-9441 **new!**
 -  50-7621
 -  50-2420
 -  50-0340
 -  50-9521 **new!**
 -  50-0002
 -  50-CG08
 -  50-0001
 -  50-0115
 -  50-9140 **new!**
 -  50-2597
 -  50-9361 **new!**
 -  50-9321 **new!**
 -  50-0233
 -  50-1585
 -  50-0326
-  8-0855

-  50-2925
 -  50-0072
 -  50-1795
 -  50-2271
 -  50-0356
 -  50-0405
 -  50-0003
 -  50-0396
 -  50-2077
 -  50-0214
 -  50-0130
 -  50-1585
 -  50-0326
-  8-0856

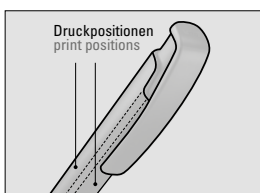
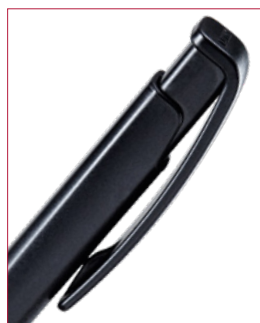

Einzigartiger Vierkantschaft, welcher sich im Griffbereich in eine angenehm greifende, runde Schaftform verwandelt.

Unique four-edged barrel, which transforms into a pleasant round barrel shape in the grip area.

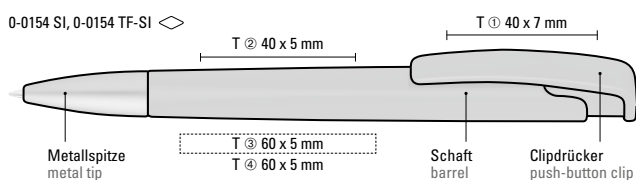

0-0154 SI: Druckkugelschreiber mit geometrisch wechselnder Schaftform, matt gedecktem Gehäuse und Metallspitze matt verchromt.

0-0154 TF-SI: Druckkugelschreiber mit geometrisch wechselnder Schaftform, transparent gefrostetem Gehäuse und Metallspitze matt verchromt.

Werbeschlüssel

Schaft T, Clip T

0-0154 SI: Retractable ballpoint pen with geometric changes in the barrel, opaque matt housing and metal tip matt chrome plated.

0-0154 TF-SI: Retractable ballpoint pen with geometric changes in the barrel, transparent frosted housing and metal tip matt chrome plated.

Advertising code

barrel T, clip T

YES frozen
0-0092 TF

YES frozen SI
0-0092 TF-SI

Farb-Code/Minen
Colour code/Refills



UMA[®]
PRIME



UMA[®]
PRIME



0-0092 TF (● 8-0854)
0-0092 TF-SI (● 8-0854)

- 50-2925
- 50-0072
- 50-1795
- 50-2271
- 50-0356
- 50-0405
- 50-0003
- 50-0396
- 50-2077
- 50-0214
- 50-0130
- 50-1585
- 50-0326



● 8-0854

0-0092 TF: Druckkugelschreiber mit transparent gefrostetem Gehäuse, breitem Bogenclipdrücker und Spitze.

0-0092 TF-SI: Druckkugelschreiber mit transparent gefrostetem Gehäuse, breitem Bogenclipdrücker und silberner Spitze glanzverchromt.

Werbeschlüssel Schaft S ○, Clip T

0-0092 TF: Retractable ballpoint pen with transparent frosted housing, wide curved clip button and tip.

0-0092 TF-SI: Retractable ballpoint pen with transparent frosted housing, wide curved clip button and tip chrome plated.

Advertising code barrel S ○, clip T

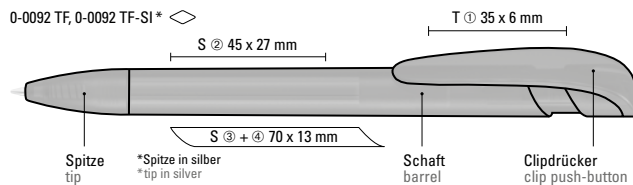

0-0092 F (● 8-0854)
0-0092 F-SI (● 8-0854)

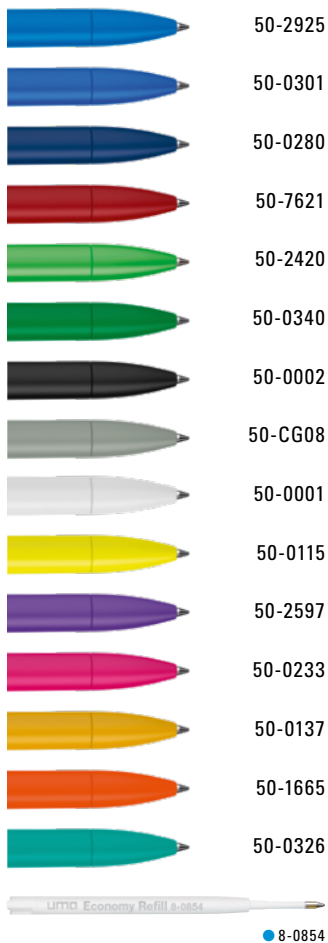

Recyclete
Variante
YES RECY
Seite/page 59



UMA
PRIME



UMA
PRIME



YES

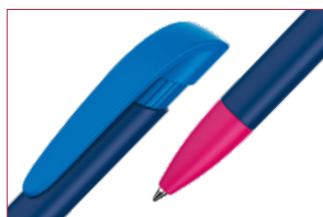

Mix n' Match: Ab 2.000 Stück kann das Modell farblich kombiniert werden. Aufpreis für Kombimodell 0-0092 FV auf Anfrage.

Mix n' Match: From 2,000 pieces, you can choose any colour combination. Additional charge for combination model 0-0092 FV on request.

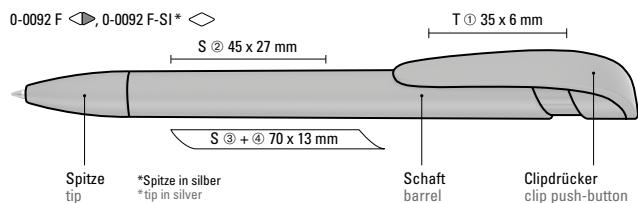

0-0092 F: Druckkugelschreiber mit gedeckt mattem Gehäuse, breitem Bogenclipdrücker und Spitze.

0-0092 F-SI: Druckkugelschreiber mit gedeckt mattem Gehäuse, breitem Bogenclipdrücker und silberner Spitze glanzverchromt.

Werbeschlüssel

Schaft S ○, Clip T

0-0092 F: Retractable ballpoint pen with opaque matt housing, wide curved clip button and tip.

0-0092 F-SI: Retractable ballpoint pen with opaque matt housing, wide curved clip button and tip chrome plated.

Advertising code

barrel S ○, clip T

YES SI
0-0093 SI

YES transparent SI
0-0093 T-SI

YES LUX SI
0-0093 LUX SI

Farb-Code/Minen
Colour code/Refills



UMA[®]
PRIME



UMA[®]
PRIME



0-0093 SI (● 8-0855)

50-0002



50-0001



● 8-0855

0-0093 T-SI (● 8-0856)

50-2925



50-0072



50-1795



50-2271



50-0356



50-0405



50-0003



50-0396



50-2077



50-0214



50-0130



50-1585



50-0326



50-0483



● 8-0856

0-0093 LUX SI (● 8-0855)

50-0004



● 8-0855

0-0093 SI: Druckkugelschreiber mit gedeckt glänzendem Gehäuse in schwarz oder weiß, breitem Bogenclipdrücker und schwerer Metallspitze glanzverchromt.

0-0093 T-SI: Druckkugelschreiber mit transparent glänzendem Gehäuse, breitem Bogenclipdrücker und schwerer Metallspitze glanzverchromt.

0-0093 LUX SI: Druckkugelschreiber mit gedeckt glänzendem Gehäuse in silber, breitem Bogenclipdrücker und schwerer Metallspitze glanzverchromt.

Werbeschlüssel Schaft S ○, Clip T

0-0093 SI: Retractable ballpoint pen with opaque glossy housing in black or white, wide curved clip button and heavy metal tip chrome plated.

0-0093 T-SI: Retractable ballpoint pen with transparent glossy housing, wide curved clip button and heavy metal tip chrome plated.

0-0093 LUX SI: Retractable ballpoint pen with opaque glossy housing in silver, wide curved clip button and heavy metal tip chrome plated.

Advertising code barrel S ○, clip T

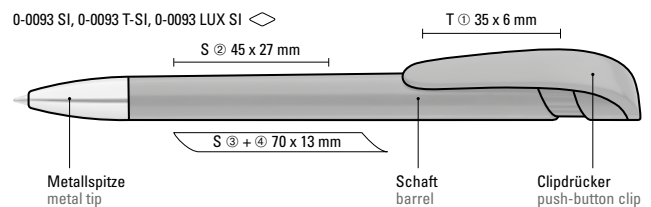

Farb-Code/Minen
Colour code/Refills

YES
0-0093

YES transparent
0-0093 T

YES LUX
0-0093 LUX

129



UMQ[®]
PRIME



UMQ[®]
PRIME



YES



Antibakterielle
Variante
YES ANTIBAC
Seite/page 59

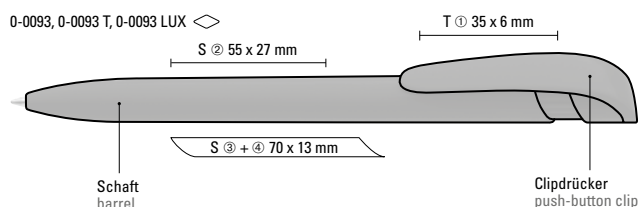

0-0093: Druckkugelschreiber mit gedeckt glänzendem Gehäuse in schwarz oder weiß und breitem Bogenclipdrücker.

0-0093 T: Druckkugelschreiber mit transparent glänzendem Gehäuse und breitem Bogenclipdrücker.

0-0093 LUX: Druckkugelschreiber mit gedeckt glänzendem Gehäuse in silber oder gold und breitem Bogenclipdrücker.

Werbeschlüssel Schaft S ⊕, Clip T

0-0093: Retractable ballpoint pen with opaque glossy housing in black or white and wide curved clip button.

0-0093 T: Retractable ballpoint pen with transparent glossy housing and wide curved clip button.

0-0093 LUX: Retractable ballpoint pen with opaque glossy housing in silver or gold and wide curved clip button.

Advertising code barrel S ⊕, clip T



0-0037 (● 8-0865)

- 20-2925
- 20-0301
- 20-0280
- 20-7621
- 20-2420
- 20-0340
- 20-0002
- 20-CG08
- 20-0001
- 20-0115
- 20-2597
- 20-0233
- 20-1585
- 20-0326

8-0865

UMA[®]
PRIME

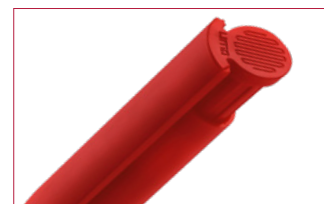

Recycelte
Variante
HAPPY RECY
Seite/page 69

0-0037 ◊

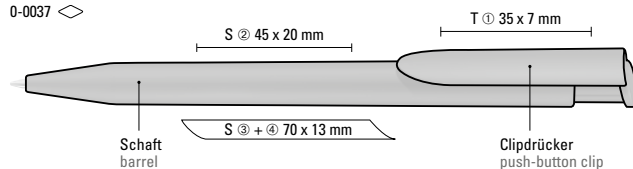

0-0037: Druckkugelschreiber mit gedeckt mattem Gehäuse und Clipdrücker.

0-0037: Retractable ballpoint pen with opaque matt housing and clip button.

Werbeschlüssel

Schaft S ◯, Clip T

Advertising code

barrel S ◯, clip T

0-0037 TF (● 8-0865)

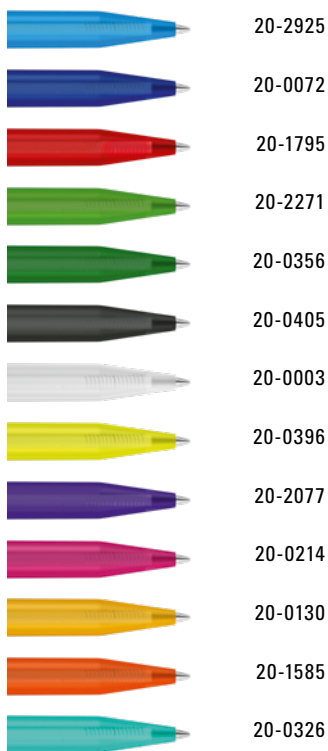

0-0037 K-TF (● 8-0865)



● 8-0865



0-0037 TF, 0-0037 K-TF* ◇

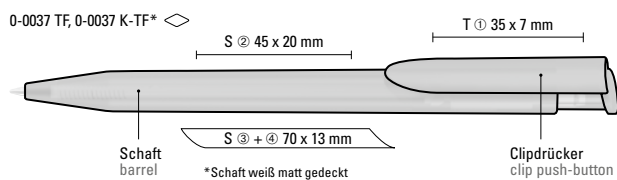

0-0037 TF: Druckkugelschreiber mit transparent gefrostetem Gehäuse und Clipdrücker.

0-0037 K-TF: Druckkugelschreiber mit gedeckt mattem Gehäuse in weiß und farbig transparent gefrostetem Clipdrücker.

0-0037 TF: Retractable ballpoint pen with transparent frosted housing and clip button.

0-0037 K-TF: Retractable ballpoint pen with opaque matt housing in white and coloured transparent frosted clip button.

















Werbeschlüssel

Schaft S ○, Clip T

Advertising code

barrel S ○, clip T



- 0-0096 SI (● 8-0854)
-  50-0002
 -  50-0001
- 0-0096 T-SI (● 8-0854)
-  50-2925
 -  50-0072
 -  50-1795
 -  50-2271
 -  50-0356
 -  50-0405
 -  50-0003
 -  50-0396
 -  50-2077
 -  50-0214
 -  50-0130
 -  50-1585
 -  50-0326
-  8-0854



UMA[®]
PRIME



UMA[®]
PRIME

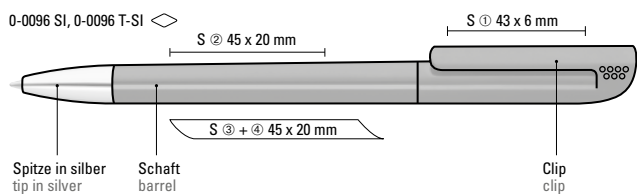

0-0096 SI: Drehkugelschreiber mit gedeckt glänzendem Gehäuse, matter Clipoberfläche und Spitze glanzverchromt.

0-0096 T-SI: Drehkugelschreiber mit transparent glänzendem Gehäuse, gefrosteter Clipoberfläche und Spitze glanzverchromt.

0-0096 SI: Twist ballpoint pen with opaque glossy housing, matt clip surface and tip chrome plated.

0-0096 T-SI: Twist ballpoint pen with transparent housing, matt clip surface and tip chrome plated.

Werbeschlüssel

Schaft S, Clip S

Advertising code

barrel S, clip S

TWISTY SI
0-0040 SI

TWISTY frozen
0-0040 TF

Farb-Code/Minen
Colour code/Refills



0-0040 SI (● 8-0854)

58-0004



0-0040 TF (● 8-0854)

50-2925



50-0072



50-1795



50-2271



50-0356



50-0405



50-0003



50-0396



50-2077



50-0130



50-0214



50-1585



● 8-0854

0-0040 SI: Drehkugelschreiber mit gedeckt mattem Gehäuse in silber.

0-0040 TF: Drehkugelschreiber mit transparent gefrostetem Gehäuse.









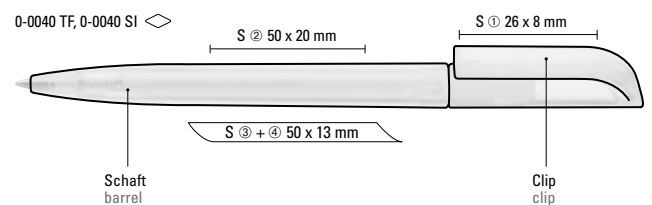







Werbeschlüssel Schaft S ○, Clip S

0-0040 SI: Twist ballpoint pen with opaque matt housing in silver.

0-0040 TF: Twist ballpoint pen with transparent frosted housing.

Advertising code barrel S ○, clip S



- 0-0077 (● 8-0865)
-  20-0002
-  20-0001
- 0-0077 T (● 8-0865)
-  20-2925
-  20-7687
-  20-1795
-  20-2420
-  20-0347
-  20-0405
-  20-0003
-  20-0101
-  20-0266
-  20-2039
-  20-0130
-  20-1665
-  20-0326
-  20-0865

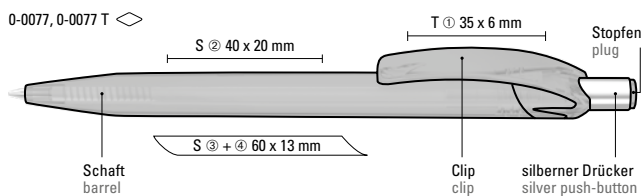

0-0077: Druckkugelschreiber mit glänzend gedecktem Gehäuse und Drückerstopfen in schwarz oder weiß. Drücker in silber glänzend.

0-0077 T: Druckkugelschreiber mit glänzend transparentem Gehäuse und Drückerstopfen. Drücker in silber glänzend.

0-0077: Retractable ballpoint pen with opaque glossy housing and plug in black or white. Push-button silver glossy.

0-0077 T: Retractable ballpoint pen with transparent glossy housing and plug. Push-button silver glossy.

Werbeschlüssel

Schaft S, Clip T

Advertising code

barrel S, clip T

X-DREAM
0-0090

X-DREAM CO SM
0-0090 CO-SM

Farb-Code/Minen
Colour code/Refills



0-0090 (● 8-0855)

50-0301



50-7621



50-0340



50-0002



50-0428



50-0115



50-1665



0-0090 CO-SM (● 8-0855)

50-2925



50-0280



50-7621



50-0340



50-0002



50-0428



50-0115



50-1665



50-0326



● 8-0855

0-0090: Druckkugelschreiber mit gedeckt mattem Gehäuse, Bogenclipdrücker und Spitze in weiß, ergonomische, farbige Gummigriffzone.

0-0090 CO-SM: Druckkugelschreiber mit gedeckt glänzendem Gehäuse, Bogenclipdrücker, ergonomische Gummigriffzone und Metallspitze matt verchromt.

Werbeschlüssel

Schaft S, Clip T









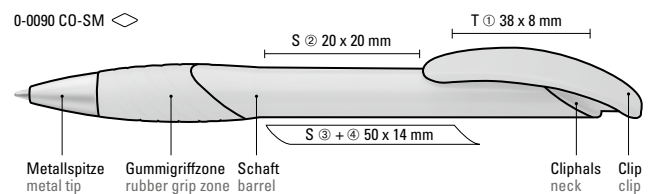
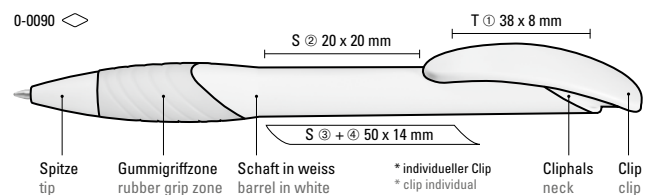

0-0090: Retractable ballpoint pen with opaque matt housing, curved clip push-button and tip in white, ergonomic coloured rubber grip zone.

0-0090 CO-SM: Retractable ballpoint pen with opaque glossy housing, curved clip button, ergonomic coloured rubber grip zone and metal tip matt chrome plated.

Advertising code

barrel S, clip T

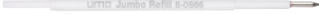

	0-0087 (● 8-0866)
	44-0002
	44-0001
	44-2925
	44-0281
	44-0187
	44-0356
	44-0011
	44-0421
	44-0116
	44-0165
	44-0326
	● 8-0866

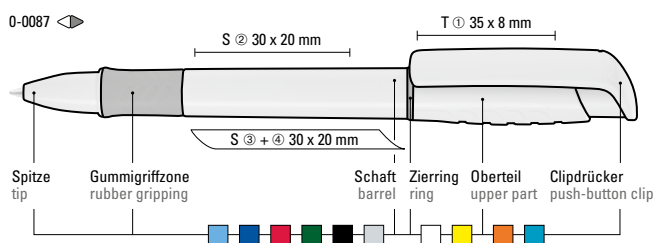

Mix n' Match: Ab 2.000 Stück kann das Modell farblich kombiniert werden.

0-0087: Druckkugelschreiber mit gedeckt glänzendem Gehäuse in weiß, Griffzone und Zierring farbig oder unifarben gedeckt glänzend schwarz.

Werbeschlüssel

Schaft S, Clip T

Mix n' Match: From 2,000 pieces, you can choose any colour combination.

0-0087: Retractable ballpoint pen with opaque glossy housing in white, grip zone and decorative ring coloured or opaque glossy black.

Advertising code

barrel S, clip T

Ihr Lieblingsschreibgerät aus dem Schwarzwald

Die umaBlackForestPens verbinden eindrucksvoll zeitloses Design mit hochwertiger Verarbeitung und Fertigungstechnik. Die in Deutschland designten Modelle werden mit Schweizer Präzision gefertigt. Alle Einzelteile werden dann in Fischerbach, im Herzen des Schwarzwaldes, zu einem individuellen Lieblingsschreibgerät zusammengeführt. Dass die umaBlackForestPens nicht nur einwandfrei schreiben, sondern auch noch bestens Werben, dafür sorgt ein europaweit einzigartiger Veredelungspark in Fischerbach.

Mit viel Liebe zum Detail entsteht so eine besondere uma Schreibgeräte-Kollektion, die den Schwarzwälder Qualitätsgedanken weit über die Landesgrenzen hinaus positiv kommuniziert. Langlebiges Schreiben und auffallend einzigartiges Werben trifft auf ressourcenschonende Fertigungstechnik und kurze Lieferwege.



Your favourite writing instrument made in the black forest

The umaBlackForestPens impressively combine timeless design with high-quality processing and manufacturing technology. The models designed in Germany are manufactured with Swiss precision. All individual parts are merged together in Fischerbach, in the heart of the Black Forest, to create your individual favourite writing instrument. The umaBlackForestPens not only writing flawlessly, they can also advertise well, thanks to a Europe-wide unique refinement park in Fischerbach.

With a lot of love for detail, a special uma writing instrument collection is created, which is communicated the Black Forest quality ideas positively far beyond the borders of the country. Durable writing and conspicuously unique advertising meet resource-conserving manufacturing technology and short delivery routes.

Mix n' Match

Gleich und gleich gesellt sich gern. Und Gegensätze ziehen sich an. Bei uma muss das kein Widerspruch sein. Denn mit einer nahezu unerschöpflichen Palette an Kombinationsmöglichkeiten können Sie Ihr Schreibgerät in den buntesten Farben erstrahlen lassen – individueller geht's nicht!

Mix n' Match

Like attracts like! And opposites attract another! At uma, this doesn't have to be a contradiction. Because with an almost inexhaustible range of combination possibilities you can let your writing instrument shine in the brightest colours – It couldn't be more individual!

umaBlackForest
Pens

Schreiben auch Sie ein Stück Schwarzwald Geschichte.

Write a piece of Black Forest history.

Heimatverliebt und qualitätsbewusst – umaBlackForestPens!

Homely and quality conscious – umaBlackForestPens!

Geschmackvoll designt in **Deutschland**.

Präzise gefertigt in der **Schweiz**.

Exklusiv zusammengefügt und veredelt im **Schwarzwald**.

*Elegant designed in **Germany**.*

*Precisely manufactured in **Switzerland**.*

*Exclusively assembled and refined in the **Black Forest**.*

Zeitgemäßer, designorientierter Werbeträger

Contemporary modern advertising medium

Hochwertige Verarbeitung

High quality manufacture

Mix n' Match – individuelle Konfiguration möglich

Mix n' Match – individual configuration possible

Kurze Lieferwege

Short delivery routes

Langlebig – uma Tech Refill

Long-capacity – uma Tech Refill

484.754 Farbkombinationsmöglichkeiten
different colour combination options

10 Familien
families



Auch als **RECY-Varianten** erhältlich

*Also available as **RECY versions***

3 verschiedene Oberflächen
different surfaces

umaBlackForest
Pens

Die schönste Verbindung von Design und Fertigung.

The most beautiful combination of design and manufacturing.

**CHECK**

siehe Seite 142-143
see page 142-143

**CHILL**

siehe Seite 144-145
see page 144-145

**ULTIMO**

siehe Seite 146
see page 146

**ULTIMATE**

siehe Seite 147
see page 147

**PEPP**

siehe Seite 148
see page 148



SPOT
siehe Seite 149
see page 149



CHIC
siehe Seite 150
see page 150



CETA
siehe Seite 151
see page 151



CRYSTAL
siehe Seite 152-153
see page 152-153



GEOS
siehe Seite 154
see page 154



1-0142 M-SI (● 8-0855)

- 01-0284 
 - 01-0286 
 - 01-0280 
 - 01-0200 
 - 01-0375 
 - 01-0340 
 - 01-0002 
 - 01-0428 
 - 01-0001 
 - 01-0108 
 - 01-0526 
 - 01-0219 
 - 01-0172 
 - 01-2995 
 - 01-3262 
-  ● 8-0855

umaBlackForest
Pens

Die schönste Verbindung von Design und Fertigung. Geschmackvoll design in Deutschland. Präzise gefertigt in der Schweiz. Exklusiv zusammengefügt und veredelt im Schwarzwald.

The most beautiful combination of design and manufacturing. Elegant designed in Germany. Precisely manufactured in Switzerland. Exclusively assembled and refined in the Black Forest.

Mix n' Match: Alle Teile können farblich frei kombiniert werden.

1-0142 M-SI: Druckkugelschreiber mit gedeckt matten Gehäuse. Schwere Metallspitze und Metallclip glanzverchromt.

Werbeschlüssel Schaft S ○, Clip L

Mix n' Match: All parts can be colour-combined freely.

1-0142 M-SI: Retractable ballpoint pen with opaque matt housing. Heavy metal tip and metal clip chrome plated.

Advertising code barrel S ○, clip L

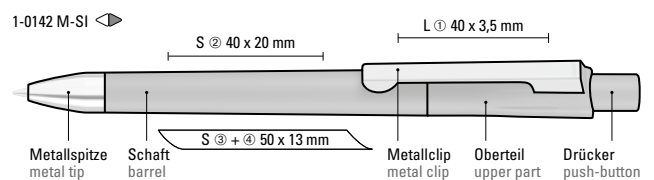

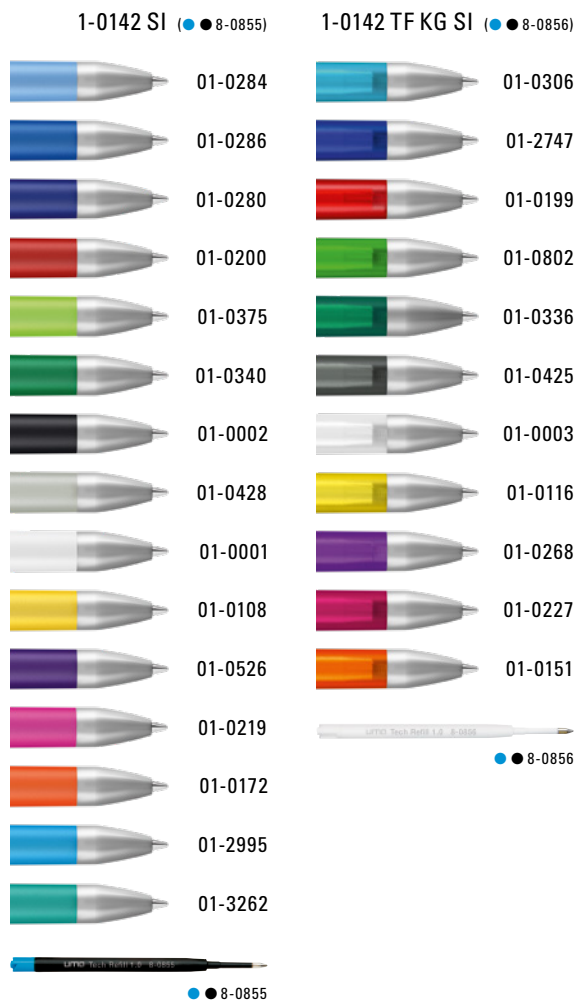

umaBlackForest *Pens*

Die schönste Verbindung von Design und Fertigung. Geschmackvoll design in Deutschland. Präzise gefertigt in der Schweiz. Exklusiv zusammengefügt und veredelt im Schwarzwald.

The most beautiful combination of design and manufacturing. Elegant designed in Germany. Precisely manufactured in Switzerland. Exclusively assembled and refined in the Black Forest.

1-0142 SI, 1-0142 TF KG SI

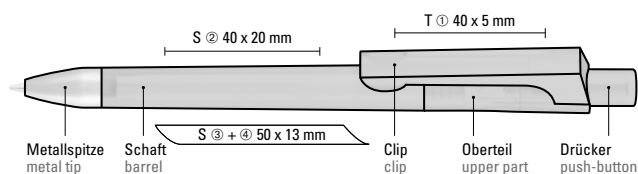

Mix n' Match: Alle Teile können farblich frei kombiniert werden.

1-0142 SI: Druckkugelschreiber mit gedeckt matten Gehäuse und schwere Metallspitze matt verchromt.

1-0142 TF KG SI: Druckkugelschreiber mit transparent gefrosteten Gehäuse und gedeckt mattem Clip in weiß. Schwere Metallspitze matt verchromt.

Werbeschlüssel Schaft S ○, Clip T

Mix n' Match: All parts can be colour-combined freely.

1-0142 SI: Retractable ballpoint pen with opaque matt housing and heavy metal tip matt chromed.

1-0142 TF KG SI: Retractable ballpoint pen with transparent frosted housing and opaque matt clip in white. Heavy metal tip matt chromed.

Advertising code barrel S ○, clip T



1-0043 SI (●●8-0855)
1-0043 C-SI (●●8-0855)



1-0043 T-SI (●●8-0856)
1-0043 CT-SI (●●8-0856)



Mit weichem Drehmechanismus
With soft twist mechanism

umaBlackForest
Pens

1-0043 SI, 1-0043 T-SI, 1-0043 C-SI, 1-0043 CT-SI ◊

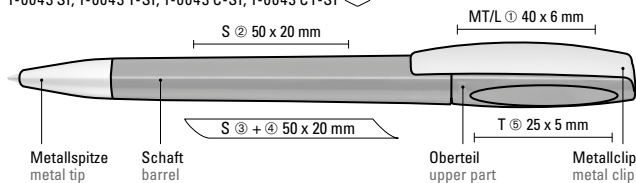

POST-CONSUMER
RECYCLED PLASTIC

Recycelte Varianten
CHILL C-SI RECY
CHILL C RECY
Seite/page 76

1-0043 SI: Drehkugelschreiber mit
gedeckt glänzendem Gehäuse.
Metallclip und schwere Metallspitze
glanzverchromt.

1-0043 T-SI: Drehkugelschreiber mit
transparent glänzendem Gehäuse.
Metallclip und schwere Metallspitze
glanzverchromt.

1-0043 C-SI: Drehkugelschreiber mit
gedeckt glänzendem Gehäuse. Metallclip
und schwere Metallspitze matt
verchromt.

1-0043 CT-SI: Drehkugelschreiber mit
transparent glänzendem Gehäuse.
Metallclip und schwere Metallspitze
verchromt.

Werbeschlüssel

Schaft S ⊕,
Clip MT/L, Oberteil T

1-0043 SI: Twist ballpoint pen with
opaque glossy housing. Metal clip and
heavy metal tip chrome plated.

1-0043 T-SI: Twist ballpoint pen with
transparent glossy housing. Metal clip
and heavy metal tip chrome plated.

1-0043 C-SI: Twist ballpoint pen with
opaque glossy housing. Metal clip and
heavy metal tip matt chromed.

1-0043 CT-SI: Twist ballpoint pen with
transparent glossy housing. Metal clip
and heavy metal tip matt chromed.

Advertising code

barrel S ⊕,
clip MT/L, upper part T

ULTIMO SI
1-0047 SI

ULTIMO transparent SI
1-0047 T-SI

Farb-Code/Minen
Colour code/Refills



1-0047 SI (● 8-0855)

01-0002



01-0001



● 8-0855

1-0047 T-SI (● 8-0856)

01-2747



01-0199



01-0336



01-0425



01-0003



01-0116



01-0268



01-0227



01-0151



ULTIMO Tech Refill 1.0 8-0856

● 8-0856

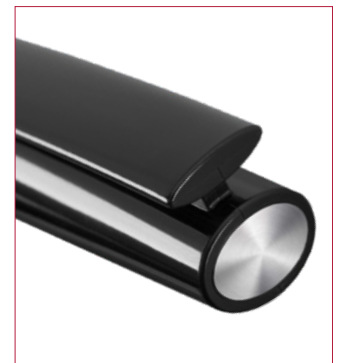

Mix n' Match: Alle Teile können farblich frei kombiniert werden.

1-0047 SI: Drehkugelschreiber mit gedeckt glänzendem Gehäuse in weiß oder schwarz und silbernem Stopfen im Oberteil. Schwere Metallspitze glanzverchromt.

1-0047 T-SI: Drehkugelschreiber mit transparent glänzendem Gehäuse und silbernem Stopfen im Oberteil. Schwere Metallspitze glanzverchromt.

Werbeschlüssel Schaft S ○, Clip T

Mix n' Match: All parts can be colour-combined freely.







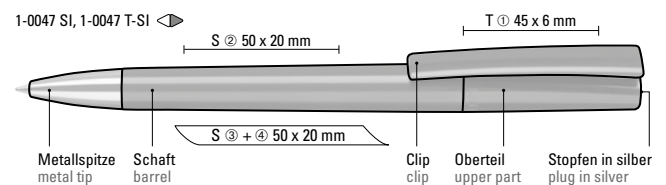























1-0047 SI: Twist ballpoint pen with opaque glossy housing in white or black and silver plug. Heavy metal tip chrome plated.

1-0047 T-SI: Twist ballpoint pen with transparent glossy housing and silver plug. Heavy metal tip chrome plated.

Advertising code barrel S ○, clip T



umaBlackForest
Pens

1-0048 SI (●●8-0855)	1-0048 SI, 1-0048 TF-SI, Stopfen ABS plug ABS	
 01-0002	 01-0004	
 01-0001	 01-0284	
 ●●8-0855	 01-0286	
1-0048 TF-SI (●●8-0856)	 01-0280	
 01-0306	 01-0200	
 01-2747	 01-0375	
 01-0199	 01-0340	
 01-0802	 01-0002	
 01-0336	 01-0430	
 01-0425	 01-0001	
 01-WG01	 01-0108	
 01-0116	 01-0526	
 01-0268	 01-0219	
 01-0227	 01-0137	
 01-0151	 01-0172	
 ●●8-0856	 01-3262	



POST-CONSUMER
RECYCLED PLASTIC

Recycelte Variante
ULTIMATE SI RECY

Seite/page 79

umaBlackForest Pens

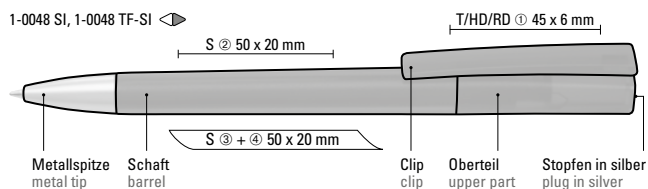

Mix n' Match: Alle Teile können farblich frei kombiniert werden.

1-0048 SI: Drehkugelschreiber mit gedeckt mattem Gehäuse in weiß oder schwarz und Stopfen optional in verschiedenen matt gedeckten Farben oder silber erhältlich. Schwere Metallspitze matt verchromt.

1-0048 TF-SI: Drehkugelschreiber mit transparent gefrostetem Gehäuse und Stopfen optional in verschiedenen matt gedeckten Farben oder silber erhältlich. Schwere Metallspitze matt verchromt.

Werbeschlüssel

Schaft S ○,
Clip T/HD/RD

Mix n' Match: All parts can be colour-combined freely.

1-0048 SI: Twist ballpoint pen with opaque matt housing in white or black and plug optionally available in various matt colours or silver. Heavy metal tip matt chromed.

1-0048 TF-SI: Twist ballpoint pen with transparent frosted housing and plug optionally available in various matt colours or silver. Heavy metal tip matt chromed.

Advertising code

barrel T ○,
clip T/HD/RD

PEPP SI
1-0145 SIPEPP transparent SI
1-0145 T-SIFarb-Code/Minen
Colour code/Refills

1-0145 SI (●● 8-0855)

01-0002



01-0001



●● 8-0855

1-0145 T-SI (●● 8-0856)

01-0306



01-2747



01-0199



01-0802



01-0336



01-0425



01-0003



01-0116



01-0268



01-0227



01-0151



●● 8-0856



●● 8-0856

umaBlackForest Pens

Mix n' Match: Alle Teile können farblich frei kombiniert werden.

1-0145 SI: Druckkugelschreiber mit gedeckt glänzendem Gehäuse, Metallzierring, Drücker und schwere Metallspitze glanzverchromt.

1-0145 T-SI: Druckkugelschreiber mit transparent glänzendem Gehäuse, Metallzierring, Drücker und schwere Metallspitze glanzverchromt.

Werbeschlüssel

Schaft S ○,
Clip T/HD/RD

Mix n' Match: All parts can be colour-combined freely.

1-0145 SI: Retractable ballpoint pen with opaque glossy housing, decorative metal ring, push-button and heavy metal tip chrome plated.

1-0145 T-SI: Retractable ballpoint pen with transparent glossy housing, decorative metal ring, push-button and heavy metal tip chrome plated.

Advertising code

barrel S ○,
clip T/HD/RD

1-0145 SI, 1-0145 T-SI ◀

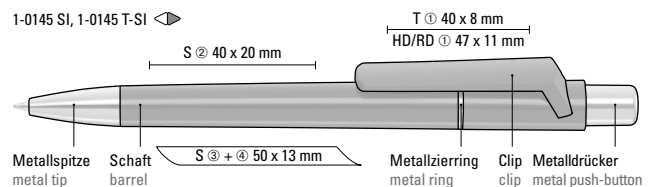
Metallspitze
metal tipSchaft
barrelMetallzierring
metal ringClip
clipMetalldrücker
metal push-button

1-0044 SI (●● 8-0855)



1-0044 T-SI (●● 8-0856)



Stopfen/plug

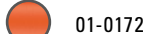
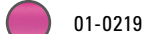
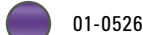
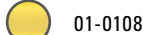
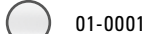
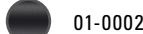
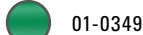
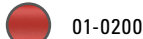

umaBlackForest
Pens

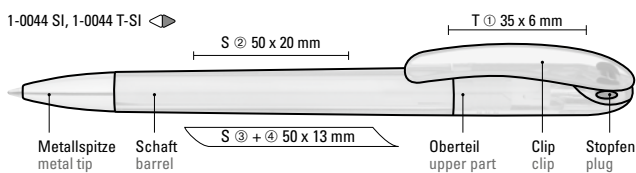

Mix n' Match: Alle Teile können farblich frei kombiniert werden.

1-0044 SI: Drehkugelschreiber mit gedeckt glänzendem Gehäuse in schwarz oder weiß und farbigem Stopfen. Schwere Metallspitze glanzverchromt.

1-0044 T-SI: Drehkugelschreiber mit transparent glänzendem Gehäuse und farbigem Stopfen. Schwere Metallspitze glanzverchromt.

Werbeschlüssel

Schaft S ○, Clip T

Mix n' Match: All parts can be colour-combined freely.

1-0044 SI: Twist ballpoint pen with opaque glossy housing in black or white and coloured plug. Heavy metal tip chrome plated.

1-0044 T-SI: Twist ballpoint pen with transparent glossy housing and coloured plug. Heavy metal tip chrome plated.

Advertising code

barrel S ○, clip T

CHIC SI
1-0149 SI

CHIC frozen SI
1-0149 TF-SI

Farb-Code/Minen
Colour code/Refills



1-0149 SI (●● 8-0855)

01-0002



01-0001

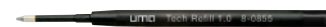

●● 8-0855

1-0149 TF-SI (●● 8-0856)

01-2747



01-0199



01-0336



01-0425



01-WG01



01-0116



01-0268



01-0227



01-0151

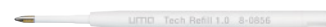

●● 8-0856

Mix n' Match: Alle Teile können farblich frei kombiniert werden.

1-0149 SI: Drehkugelschreiber mit gedecktem mattem Gehäuse, schwere Metallspitze und Metallclip matt verchromt.

1-0149 TF-SI: Drehkugelschreiber mit transparent gefrostetem Gehäuse, schwere Metallspitze und Metallclip matt verchromt.

Werbeschlüssel Schaft S ○, Clip MT/L

Mix n' Match: All parts can be colour-combined freely.

1-0149 SI: Twist ballpoint pen with opaque matt housing, heavy metal tip and metal clip matt chrome plated.

1-0149 TF-SI: Twist ballpoint pen with transparent frosted housing, heavy metal tip and metal clip matt chrome plated.

Advertising code barrel S ○, clip MT/L

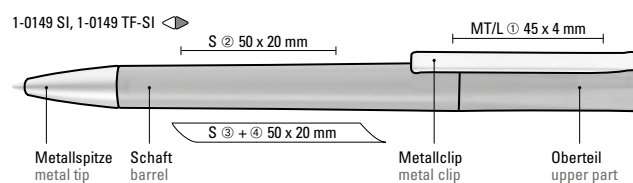

umaBlackForest
Pens

1-0041 SI (●●8-0855)



1-0041 TF-SI (●●8-0856)



Mit softem Drehmechanismus
With soft twist mechanism



umaBlackForest
Pens



POST-CONSUMER
RECYCLED PLASTIC

Recycelte Variante
CETA RECY
Seite/page 79

1-0041 SI, 1-0041 TF-SI ◀

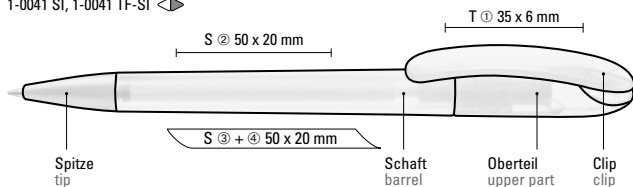

Mix n' Match: Alle Teile können farblich frei kombiniert werden.

1-0041 SI: Drehkugelschreiber mit gedeckt mattem Gehäuse. Schwere matt verchromte Metallspitze.

1-0041 TF-SI: Drehkugelschreiber mit transparent gefrostetem Gehäuse. Schwere matt verchromte Metallspitze.

Werbeschlüssel Schaft S ○, Clip T





















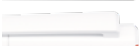





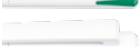



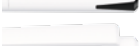

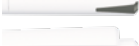
Mix n' Match: All parts can be colour-combined freely.

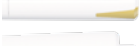
1-0041 SI: Twist ballpoint pen with opaque matt housing. Heavy metal tip matt chromed.

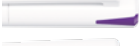
1-0041 TF-SI: Twist ballpoint pen with transparent frosted housing. Heavy metal tip matt chromed.

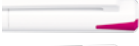
Advertising code barrel S ○, clip T

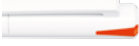

1-0147 SI (●● 8-0855)	1-0147 T-SI (●● 8-0856)
 01-0002	 01-0306
 01-0001	 01-2747
 01-0284	 01-0199
 01-0285	 01-0802
 01-0286	 01-0336
 01-1795	 01-0425
 01-0200	 01-0003
 01-0340	 01-0116
 01-0349	 01-0227
 01-0011	 01-0268
 01-0430	 01-0151
 01-0428	 ●● 8-0856
 01-0127	
 01-0108	
 01-0513	
 01-0526	
 01-0262	
 01-0219	
 01-0714	
 01-0172	
 01-0332	
 01-3262	
 ●● 8-0855	



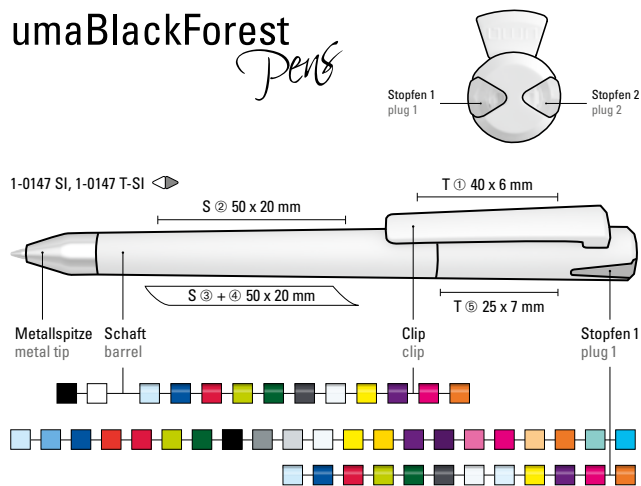

umaBlackForest Pens



1-0147 SI, 1-0147 T-SI

Metallspitze metal tip, Schaft barrel, Clip clip, Stopfen 1 plug 1, Stopfen 2 plug 2

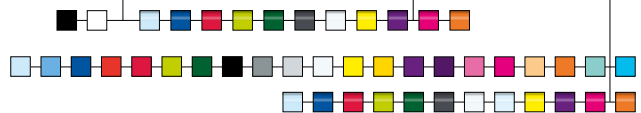
S ③ + ④ 50 x 20 mm, T ① 40 x 6 mm, T ② 25 x 7 mm



Mix n' Match: Alle Teile können farblich frei kombiniert werden.

1-0147 SI: Drehkugelschreiber mit gedeckt glänzendem Gehäuse und Oberteil mit zwei farbigen Stopfen in gedeckt oder transparent. Schwere Metallspitze glanzverchromt.

1-0147 T-SI: Drehkugelschreiber mit transparent glänzendem Gehäuse und Oberteil mit zwei farbigen Stopfen in gedeckt oder transparent glänzend. Schwere Metallspitze glanzverchromt.

Werbeschlüssel

Schaft S ○, Clip T, Oberteil T

Mix n' Match: All parts can be colour-combined freely.











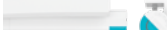

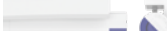

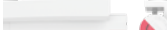

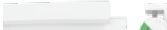

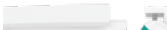

1-0147 SI: Twist ballpoint pen with opaque glossy housing and upper part with two coloured plug in opaque or transparent. Heavy metal tip chrome plated.

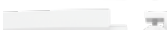
1-0147 T-SI: Twist ballpoint pen with transparent glossy housing and upper part with two coloured plug in opaque or transparent. Heavy metal tip chrome plated.

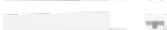
Advertising code

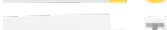
barrel S ○, clip T, upper part T

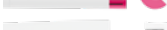
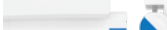
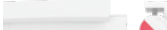
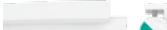
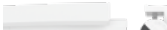

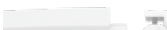
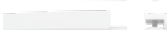
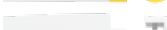
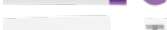
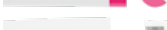
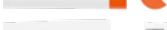
1-0148 TF-SI (● 8-0856)		1-0148 TF-SI Stopfen transparent/ plug transparent	
	01-2747		01-0306
	01-0199		01-2747
	01-0336		01-0199
	01-0425		01-0802
	01-WG01		01-0336
	01-0116		01-0425
	01-0268		01-0003
	01-0227		01-0116
	01-0151		01-0268
			01-0227
			01-0151
		Stopfen gedeckt/plug opaque	
			01-0286
			01-0200
			01-0340
			01-0002
			01-0428
			01-0001
			01-0108
			01-0526
			01-0219
			01-0172
			01-3262



umaBlackForest
Pens

1-0148 TF-SI ◀

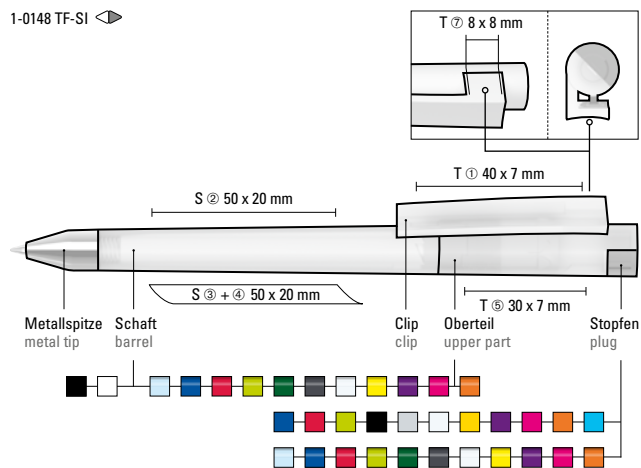

Mix n' Match: Alle Teile können farblich frei kombiniert werden.

1-0148 TF-SI: Drehkugelschreiber mit gefrostetem Gehäuse, Clip und Stopfen im Oberteil gedeckt glänzend bzw. transparent glänzend. Schwere Metallspitze glanzverchromt.

Werbeschlüssel

Schaft S ◯,
Clip T, Oberteil T

Mix n' Match: All parts can be colour-combined freely.

1-0148 TF-SI: Twist ballpoint pen with transparent frosted housing and upper part with coloured plug in opaque or transparent. Heavy metal tip chrome plated.

Advertising code

barrel S ◯,
clip T, upper part T



0-0531 (● 8-0866)



0-0531 T (● 8-0866)

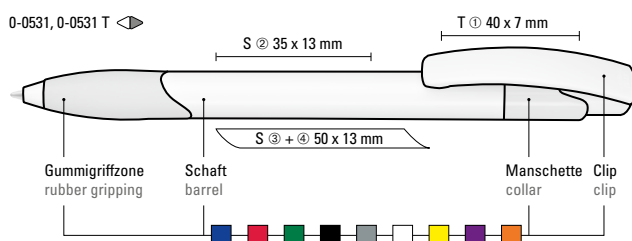

Mix n' Match: Ab 2.000 Stück kann das Modell farblich kombiniert werden.

0-0531: Druckkugelschreiber mit gedeckt glänzendem Schaft und Clipdrücker in weiß. Gummigriffzone und Manschette farbig.

0-0531 T: Druckkugelschreiber mit transparent glänzendem Schaft, Gummigriffzone und Clipdrücker.

Werbeschlüssel Schaft S ⊙, Clip T

Mix n' Match: From 2,000 pieces, you can choose any colour combination.

0-0531: Retractable ballpoint pen with opaque glossy barrel and clip push-button in white, rubber grip zone and collar coloured.

0-0531 T: Retractable ballpoint pen with transparent glossy barrel, clip push-button and rubber grip zone.

Advertising code barrel S ⊙, clip T



0-0112 SI (● 8-0866)

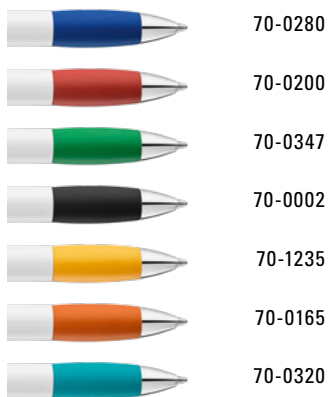

0-0112 T-SI (● 8-0866)

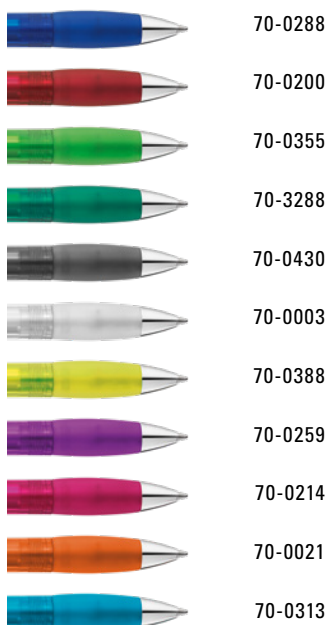

0-0112 SI, 0-0112 T-SI ◀

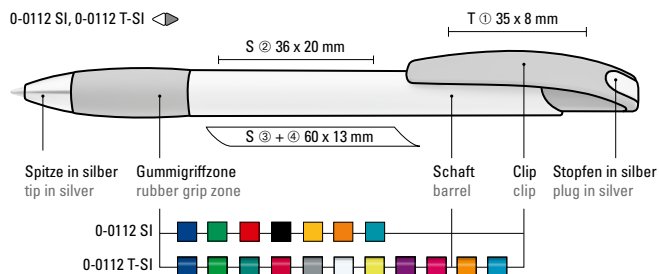

Mix n' Match: Ab 2.000 Stück kann das Modell farblich kombiniert werden.

0-0112 SI: Druckkugelschreiber mit gedeckt glänzendem Gehäuse in weiß, farbiger Gummigriffzone und Clipdrücker. Drückerstopfen und Spitze in silber glänzend.

0-0112 T-SI: Druckkugelschreiber mit transparent glänzendem Gehäuse, Gummigriffzone und Clipdrücker. Drückerstopfen und Spitze silber glänzend.

Mix n' Match: From 2,000 pieces, you can choose any colour combination.

0-0112 SI: Retractable ballpoint pen with opaque glossy housing in white, coloured rubber grip zone and clip button. Plug and tip silver glossy.

0-0112 T-SI: Retractable ballpoint pen with transparent glossy housing, rubber grip zone and clip button. Plug and tip silver glossy.

Werbeschlüssel

Schaft S ○, Clip T

Advertising code

barrel S ○, clip T

SUAL uma VISUAL uma VISU
ma VISUAL uma



AL **uma VISUAL** uma VISUA
a VISUAL uma VISUAL uma V

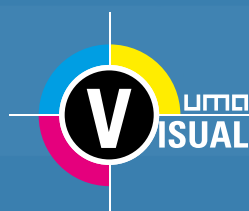



0-0134 SI (● 8-0855)

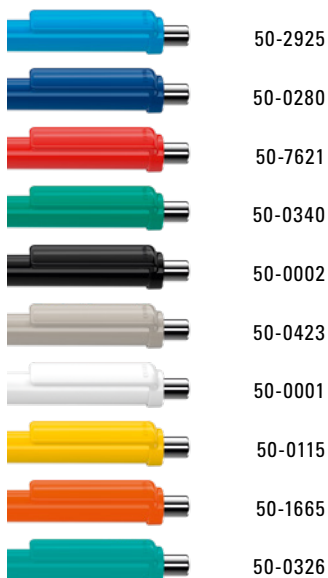

0-0134 KT-SI (● 8-0855)

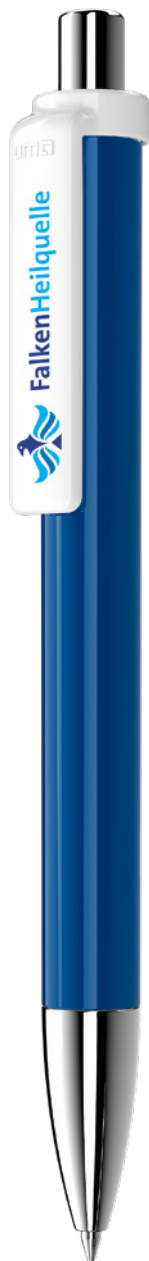
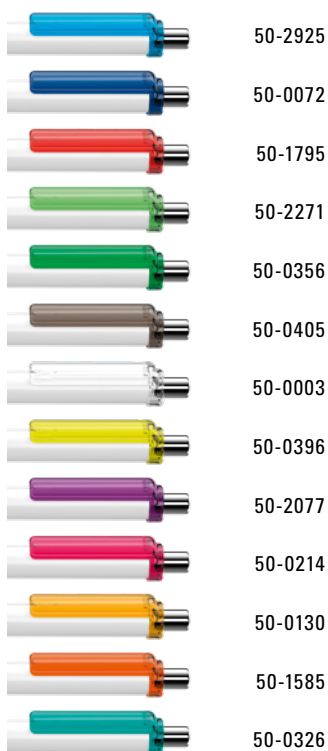

Die Modelle eignen sich für NFC-Technik.
The models are suitable for NFC technology.

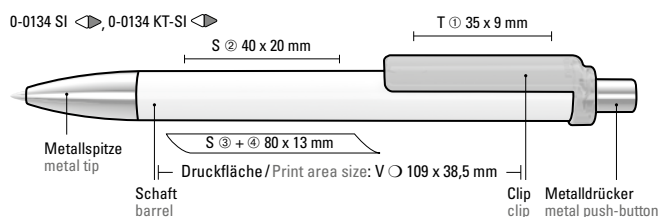

Mix n' Match: Ab 2.000 Stück kann das Modell farblich kombiniert werden.

0-0134 SI: Druckkugelschreiber mit gedeckt glänzendem Schaft und Clip, Metallspitze und Metalldrücker glanzverchromt.

0-0134 KT-SI: Druckkugelschreiber mit gedeckt glänzendem Schaft, transparent glänzendem Clip, Metallspitze und Metalldrücker glanzverchromt.

Werbeschlüssel Schaft V/S O, Clip T

Mix n' Match: From 2,000 pieces, you can choose any colour combination.

0-0134 SI: Retractable ballpoint pen with opaque glossy housing and clip, metal tip and metal push-button chrome plated.

0-0134 KT-SI: Retractable ballpoint pen with opaque glossy housing, transparent clip, metal tip and metal push-button chrome plated.

Advertising code barrel V/S O, clip T





Die Modelle eignen sich für NFC-Technik.
The models are suitable for NFC technology.

0-0136 SI ◀

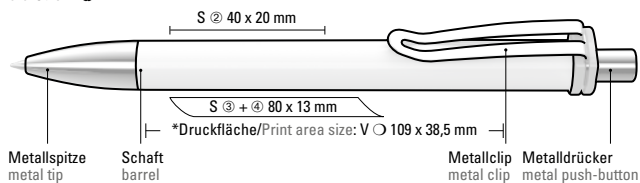

Mix n' Match: Ab 2.000 Stück kann das Modell farblich kombiniert werden.

0-0136 SI: Druckkugelschreiber mit gedeckt glänzendem Schaft und Clipaufhängung. Breiter Metallbiegeclip, Metallspitze und Metalldrücker glanzverchromt.

Werbeschlüssel

Mix n' Match: From 2,000 pieces, you can choose any colour combination.

0-0136 SI: Retractable ballpoint pen with opaque glossy housing and clip holder. Wide flexible metal clip, metal tip and metal push-button chrome plated.

Schaft V/S ∅

Advertising code

barrel V/S ∅

SUNNY frozen
0-0013 TF

FANTASY transparent
0-0011 T

FANTASY
0-0011

Farb-Code/Minen
Colour code/Refills



0-0013 TF (● 8-0866)
0-0011 T (● 8-0866)

- 70-0288
- 70-0200
- 70-0355
- 70-3288
- 70-0430
- 70-0003
- 70-0388
- 70-0259
- 70-0214
- 70-0021
- 70-0313



0-0011 (● 8-0877)

- 70-0280
- 70-0200
- 70-0347
- 70-0002
- 70-1235
- 70-0165
- 70-0320



Mix n' Match: Ab 2.000 Stück kann das Modell farblich kombiniert werden.

0-0013 TF: Druckkugelschreiber mit transparent gefrostetem Gehäuse, Gummigriffzone und Clipdrücker mit Stopfen.

0-0011 T: Druckkugelschreiber mit transparent glänzendem Gehäuse, Gummigriffzone und Clipdrücker. Stopfen silber metallic.

0-0011: Druckkugelschreiber mit gedeckt glänzendem Gehäuse und Clipdrücker in weiß, farbige Gummigriffzone und Stopfen.

Werbeschlüssel Schaft S ○, Clip T

Mix n' Match: From 2,000 pieces, you can choose any colour combination.

0-0013 TF: Retractable ballpoint pen with transparent frosted housing, rubber grip zone and clip button with plug.

0-0011 T: Retractable ballpoint pen with transparent glossy housing, rubber grip zone and clip button. Plug silver metallic.

0-0011: Retractable ballpoint pen with opaque glossy housing and clip button in white, coloured rubber grip zone and plug.

Advertising code barrel S ○, clip T

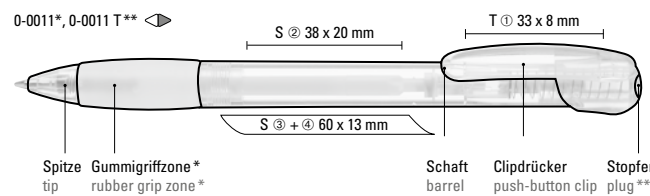
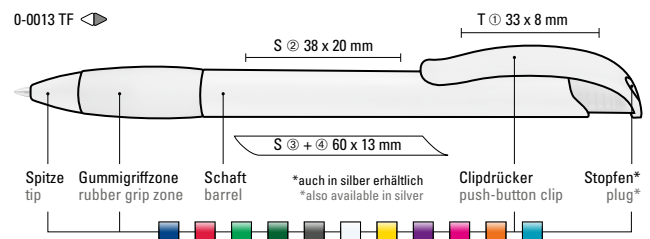

0-0011* *nicht in weiß erhältlich
0-0011 T* **silber metallic
 **silver metallic

0-0012 SI (● 8-0866)

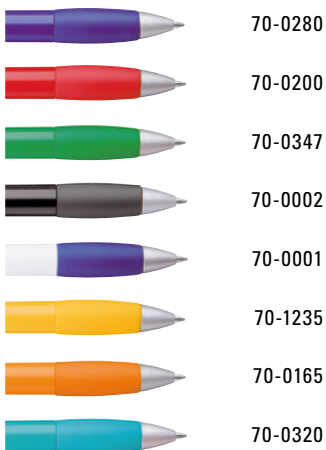

0-0012 TF-SI (● 8-0866)



0-0012 SI*, 0-0012 TF-SI ◀

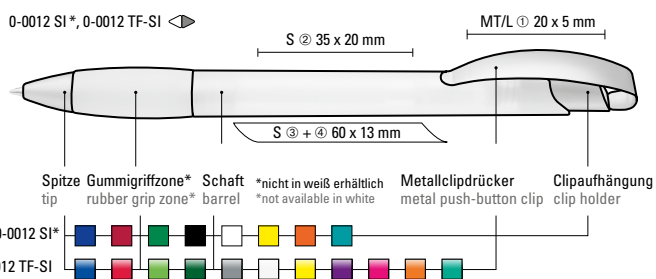

Mix n' Match: Ab 2.000 Stück kann das Modell farblich kombiniert werden.

0-0012 SI: Druckkugelschreiber mit gedeckt glänzendem Gehäuse, Gummigriffzone, matt verchromtem Metallclipdrücker und Spitze matt silber.

0-0012 TF-SI: Druckkugelschreiber mit transparent gefrostetem Gehäuse, Gummigriffzone, matt verchromtem Metallclipdrücker und Spitze matt silber.

Werbeschlüssel Schaft S ○, Clip MT/L

















Mix n' Match: From 2,000 pieces, you can choose any colour combination.

0-0012 SI: Retractable ballpoint pen with opaque glossy housing, rubber grip zone, metal clip button matt chromed and tip matt silver.

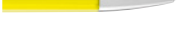
0-0012 TF-SI: Retractable ballpoint pen with transparent frosted housing, rubber grip zone, metal clip button matt chrome plated and tip matt silver.

Advertising code barrel S ○, clip MT/L



0-0124 SI (● 8-0855)	
	50-0002
	50-0001
	● 8-0855
0-0124 T-SI (● 8-0856)	
	50-2925
	50-0072
	50-1795
	50-2271
	50-0356
	50-0405
	50-0003
	50-0396
	50-2077
	50-0214
	50-0130
	50-1585
	50-0326
	50-0483
	● 8-0856

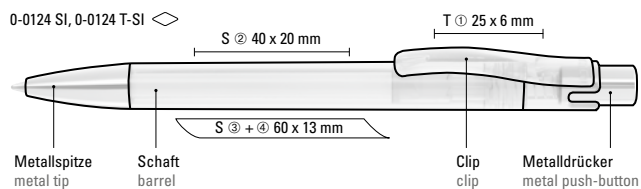

0-0124 SI: Druckkugelschreiber mit gedeckt glänzendem Gehäuse, Metalldrücker und schwerer Metallspitze glanzverchromt.

0-0124 T-SI: Druckkugelschreiber mit transparent glänzendem Gehäuse, Metalldrücker und schwerer Metallspitze glanzverchromt.

Werbeschlüssel

Schaft S, Clip T



















0-0124 SI: Retractable ballpoint pen with opaque glossy housing, heavy metal tip and metal push-button chrome plated.

0-0124 T-SI: Retractable ballpoint pen with transparent housing, heavy metal tip and metal push-button chrome plated.

Advertising code

barrel S, clip T

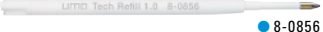

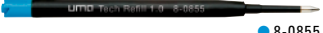
- 0-0124 M-SI (● 8-0855)
-  50-0002
 -  50-0001
 -  8-0855
- 0-0124 TM-SI (● 8-0856)
-  50-2925
 -  50-0072
 -  50-1795
 -  50-2271
 -  50-0356
 -  50-0405
 -  50-0003
 -  50-0396
 -  50-0130
 -  50-2077
 -  50-0214
 -  50-1585
 -  50-0326
 -  50-0483
 -  8-0856
- 0-0124 LUX M-SI (● 8-0855)
-  50-0004
 -  8-0855

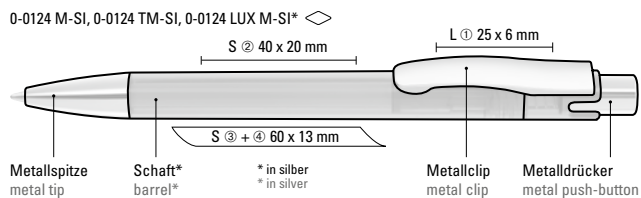

0-0124 M-SI: Druckkugelschreiber mit gedeckt glänzendem Gehäuse, schwerer Metallspitze, Metalldrücker und Metallclip glanzverchromt.

0-0124 TM-SI: Druckkugelschreiber mit transparent glänzendem Gehäuse, schwerer Metallspitze, Metalldrücker und Metallclip glanzverchromt.

0-0124 LUX M-SI: Druckkugelschreiber mit silber glänzendem Gehäuse, schwerer Metallspitze, Metalldrücker und Metallclip glanzverchromt.

Werbeschlüssel

Schaft S, Clip L

0-0124 M-SI: Retractable ballpoint pen with opaque glossy housing, heavy metal tip, metal push-button and metal clip chrome plated.

0-0124 TM-SI: Retractable ballpoint pen with transparent housing, heavy metal tip, metal push-button and metal clip chrome plated.

0-0124 LUX M-SI: Retractable ballpoint pen with opaque glossy housing in silver, heavy metal tip, metal push-button and metal clip chrome plated.

Advertising code

barrel S, clip L

STRIPE
0-0039

LOOK grip SI
0-0122 SI

LOOK grip transparent SI
0-0122 T-SI

Farb-Code/Minen
Colour code/Refills



0-0039 (● 8-0875)



● 8-0875

0-0122 SI (● 8-0855)

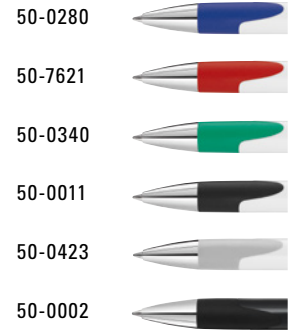

● 8-0855

0-0122 T-SI (● 8-0856)



● 8-0856

0-0039: Druckkugelschreiber mit gedeckt weißem Gehäuse, transparent gefrosteter Gummigriffzone, Zierring und Clipschale.

0-0122 SI: Druckkugelschreiber mit gedeckt glänzendem Gehäuse, Gummigriffzone und schwerer Metallspitze glanzverchromt.

0-0122 T-SI: Druckkugelschreiber mit transparent glänzendem Gehäuse, Gummigriffzone und schwerer Metallspitze glanzverchromt.

Werbeschlüssel

Schaft S, Clip T

0-0039: Retractable ballpoint pen with opaque housing in white, transparent frosted rubber grip zone, decorative ring and clip shell.

0-0122 SI: Retractable ballpoint pen with opaque glossy housing, rubber grip zone and heavy metal tip chrome plated.

0-0122 T-SI: Retractable ballpoint pen with transparent housing, rubber grip zone and heavy metal tip chrome plated.

Advertising code

barrel S, clip T

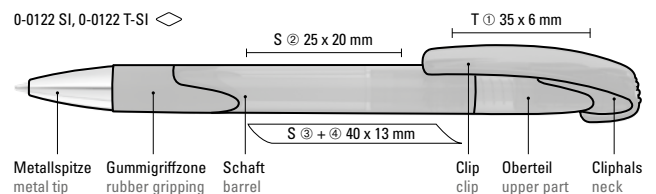
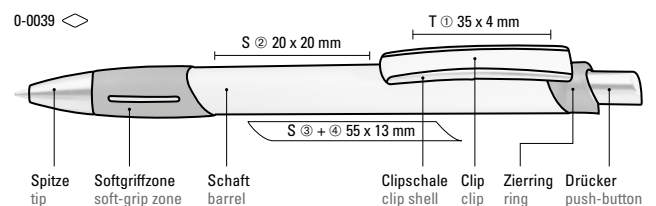

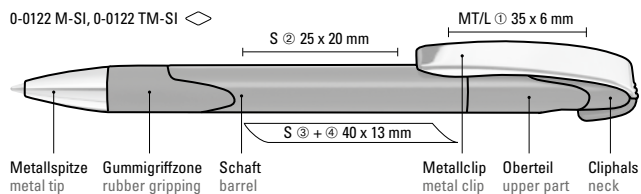
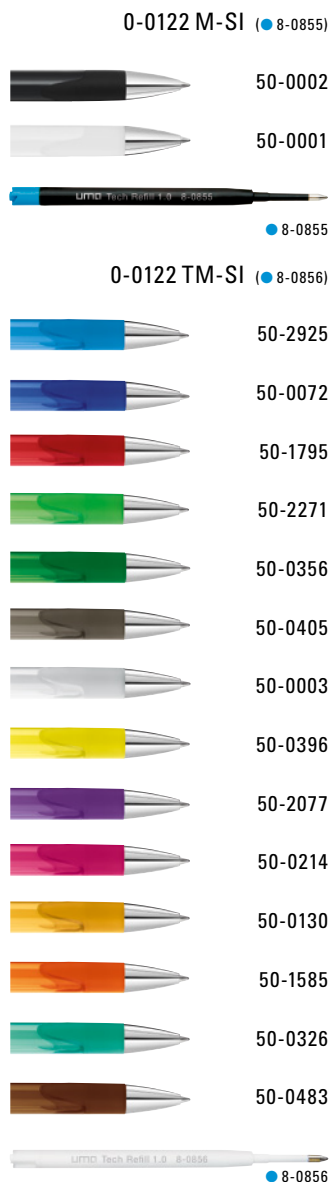

0-0122 M-SI: Druckkugelschreiber mit gedeckt glänzendem Gehäuse, Gummigriffzone, schwerer Metallspitze und Metallclip glanzverchromt.

0-0122 TM-SI: Druckkugelschreiber mit transparent glänzendem Gehäuse, Gummigriffzone, schwerer Metallspitze und Metallclip glanzverchromt.

Werbeschlüssel Schaft S, Clip MT/L



















0-0122 M-SI: Retractable ballpoint pen with opaque glossy housing, rubber grip zone, heavy metal tip and metal clip chrome plated.

0-0122 TM-SI: Retractable ballpoint pen with transparent housing, rubber grip zone, heavy metal tip and metal clip chrome plated.

Advertising code barrel S, clip MT/L



0-0046 (● 8-0856)

-  50-0002
-  50-0001
-  50-2925
-  50-0072
-  50-1795
-  50-2271
-  50-0356
-  50-0405
-  50-0003
-  50-0396
-  50-2077
-  50-0194
-  50-0214
-  50-0130
-  50-1585
-  50-0326
-  50-0465
-  50-0384



● 8-0856

0-0046 SI (● 8-0855)



50-0004



● 8-0855

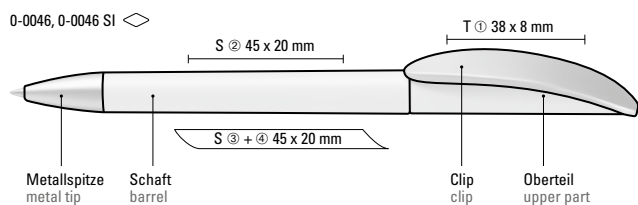

0-0046: Drehkugelschreiber mit transparent gefrostetem oder gedeckt mattem Gehäuse, Bogenclip silber matt und schwerer Metallspitze matt verchromt.

0-0046 SI: Drehkugelschreiber mit gedeckt silbernem Gehäuse, Bogenclip silber matt und schwerer Metallspitze matt verchromt.

Werbeschlüssel

Schaft S, Clip T













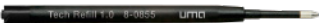

0-0046: Twist ballpoint pen with transparent frosted or opaque matt housing, curved clip silver matt and heavy metal tip matt chromed.

0-0046 SI: Twist ballpoint pen with opaque silver housing, curved clip silver matt and heavy metal tip matt chromed.

Advertising code

barrel S, clip T



- 0-0146 SI** (● 8-0855)
-  50-0002
 -  50-0001
 -  ● 8-0855
- 0-0146 T-SI** (● 8-0856)
-  50-2925
 -  50-0072
 -  50-1795
 -  50-2271
 -  50-0356
 -  50-0405
 -  50-0003
 -  50-0396
 -  50-0214
 -  50-2077
 -  50-0130
 -  50-1585
 -  ● 8-0856

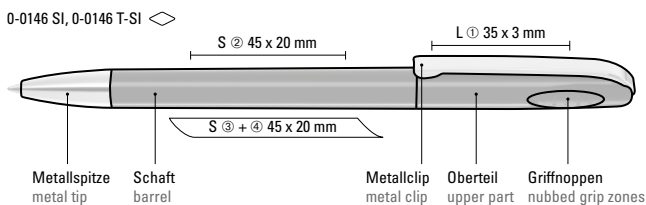

0-0146 SI: Drehkugelschreiber mit glänzend gedecktem Gehäuse, schwerer Metallspitze und Metallclip. Griffnoppen in der Kappe unterstützen den komfortablen Drehmechanismus.

0-0146 T-SI: Drehkugelschreiber mit glänzend transparentem Gehäuse, schwerer Metallspitze und Metallclip. Griffnoppen in der Kappe unterstützen den komfortablen Drehmechanismus.

Werbeschlüssel

Schaft S, Clip L

0-0146 SI: Twist ballpoint pen with opaque glossy housing, heavy metal tip and metal clip. A nubbed grip zone on the cap supports the comfortable twisting mechanism.

0-0146 T-SI: Twist ballpoint pen with transparent glossy housing, heavy metal tip and metal clip. A nubbed grip zone on the cap supports the comfortable twisting mechanism.

Advertising code

barrel S, clip L

JAZZ
0-0580

JAZZ frozen
0-0580 TF

Farb-Code/Minen
Colour code/Refills



0-0580 (● 8-0854)

50-0002



50-0001



0-0580 TF (● 8-0854)

50-0072



50-1795



50-2271



50-0356



50-0405



50-0396



50-2077



50-0214



50-1585



● 8-0854

0-0580: Druckkugelschreiber mit gedecktem Gehäuse, Gummigriffzone und geschwungenem Metallclip. Drücker, Zierring und Spitze in matt silber.

0-0580 TF: Druckkugelschreiber mit transparent gefrostetem Gehäuse, Gummigriffzone und geschwungenem Metallclip. Drücker, Zierring und Spitze in matt silber.

0-0580: Retractable ballpoint pen with opaque housing, rubber grip zone and curved metal clip. Push-button, ring and tip silver matt.

0-0580 TF: Retractable ballpoint pen with transparent frosted housing, rubber grip zone and curved metal clip. Push-button, ring and tip silver matt.

0-0580, 0-0580 TF ◇

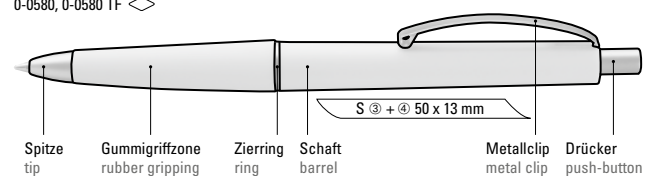

Werbeschlüssel

Schaft S

Advertising code

barrel S

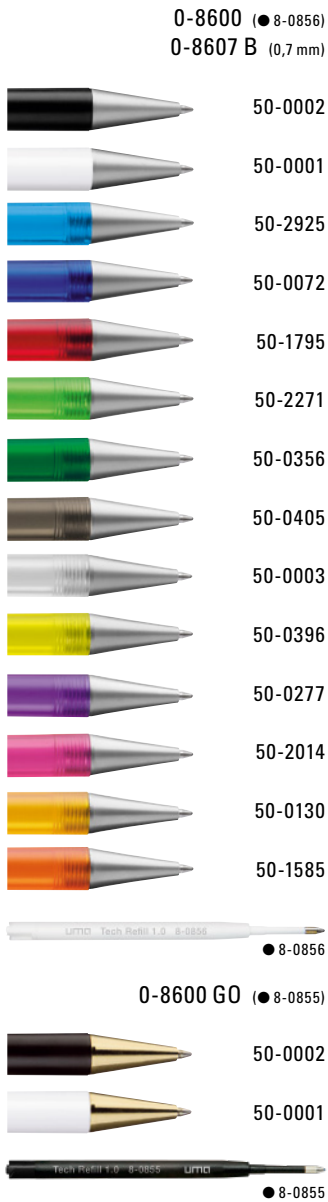

UMTD
PRIME

0-8600: Druckkugelschreiber mit transparent gefrostetem oder gedecktem Gehäuse. Metalldrücker, Metallclip und Metallspitze matt verchromt.

0-8607 B: Druckbleistift (0,7mm) mit transparent gefrostetem oder gedecktem Gehäuse. Metalldrücker, Metallclip und Metallspitze matt verchromt.

0-8600 GO: Druckkugelschreiber mit schwarzem oder weißem Gehäuse. Metalldrücker, Metallclip und Metallspitze gold glänzend.

0-8600: Retractable ballpoint pen with transparent frosted or opaque housing. Metal push-button, metal clip and metal tip matt chromed.

0-8607 B: Mechanical pencil (0.7mm) with transparent frosted or opaque housing. Metal push-button, metal clip and metal tip matt chromed.

0-8600 GO: Retractable ballpoint pen with opaque housing in black or white. Metal push-button, metal clip and metal tip gold-plated.

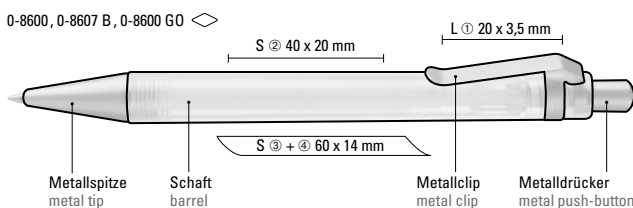

Werbeschlüssel

Schaft S, Clip L

Advertising code

barrel S, clip L

QUANTUM
0-0053

QUANTUM R
0-0053 R

Farb-Code/Minen
Colour code/Refills



0-0053 (● 8-0855)
0-0053 R (● 8-0806)

52-0002 

52-0001 

 LUMIC Tech Rollerball 1.0 8-0855

 LUMIC High Class Rollerball Refill 8-0806

0-0053: Drehkugelschreiber mit gedeckt glänzendem Gehäuse und Gummigriffzone in schwarz. Metallclip, Zierring und Metallspitze glanzverchromt.

0-0053 R: Rollerball mit gedeckt glänzendem Gehäuse. Metallclip und Zierring glanzverchromt.

Werbeschlüssel 0-0053

Schaft S,
Oberteil T

Werbeschlüssel 0-0053 R

Schaft T,
Kappe T

0-0053: Twist ballpoint pen with opaque glossy housing and rubber grip zone in black. Metal clip, decorative ring and tip chrome plated.

0-0053 R: Rollerball with opaque glossy housing. Metal clip and decorative ring chrome plated.

Advertising code 0-0053

barrel S,
upper part T

Advertising code 0-0053 R

barrel T,
cap T

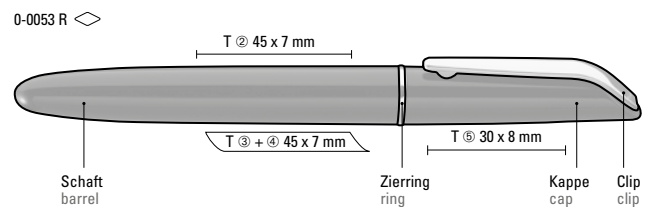
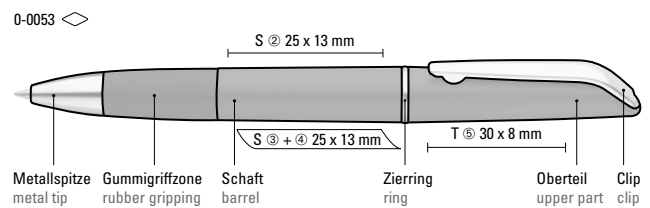

0-0053 M (● 8-0855)
0-0053 MR (● 8-0806)



0-0053 M ◊

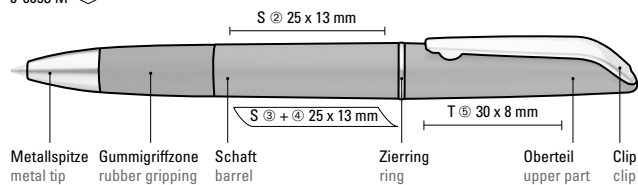

0-0053 MR ◊

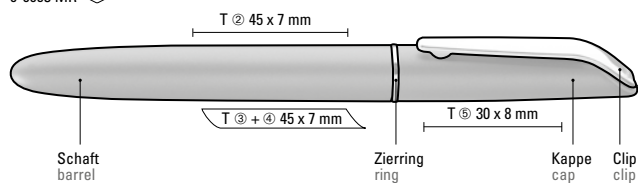

0-0053 M: Drehkugelschreiber mit Gehäuse im Metallicfarben, Gummigriffzone in schwarz. Metallclip, Zierring und Metallspitze glanzverchromt.

0-0053 MR: Rollerball mit Gehäuse in Metallicfarben. Metallclip und Zierring glanzverchromt.

Werbeschlüssel 0-0053 M

Werbeschlüssel 0-0053 MR

Schaft S,
Oberteil T

Schaft T,
Kappe T

0-0053 M: Twist ballpoint pen with housing in metallic colours and rubber grip zone in black. Metal clip, decorative ring and tip chrome plated.

0-0053 MR: Rollerball with housing in metallic colours. Metal clip and decorative ring chrome plated.

Advertising code 0-0053 M

Advertising code 0-0053 MR

barrel S,
upper part T

barrel T,
cap T



LT FARBVIE
LOURS VAR



FALT **FARBVIELFALT** FARBV
VARIETY OF COLOURS VA

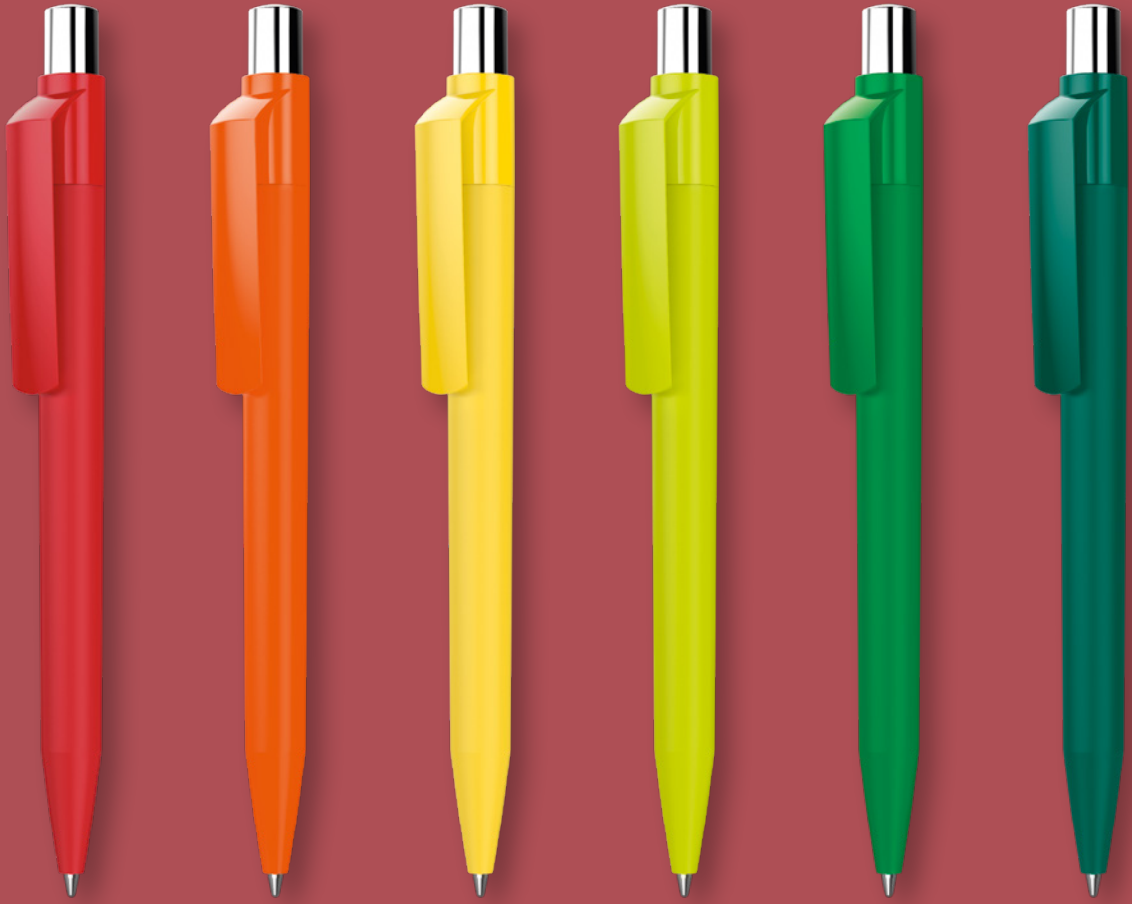

DIE BUNTE WELT VON UMA

Wir bringen Farbe in die Welt der Schreibgeräte. Denn mit uma steht Ihnen nicht nur eine riesige Palette an unterschiedlichen Farben zur Verfügung, sondern auch beinahe unbegrenzte Möglichkeiten für bunte Kombinationen und Variationen.

THE COLOURFUL WORLD OF UMA

We bring colour into the world of writing instruments. You see, uma not only has a gigantic range of different colours at its disposal. It also offers almost unlimited scope for colourful combinations and variations.



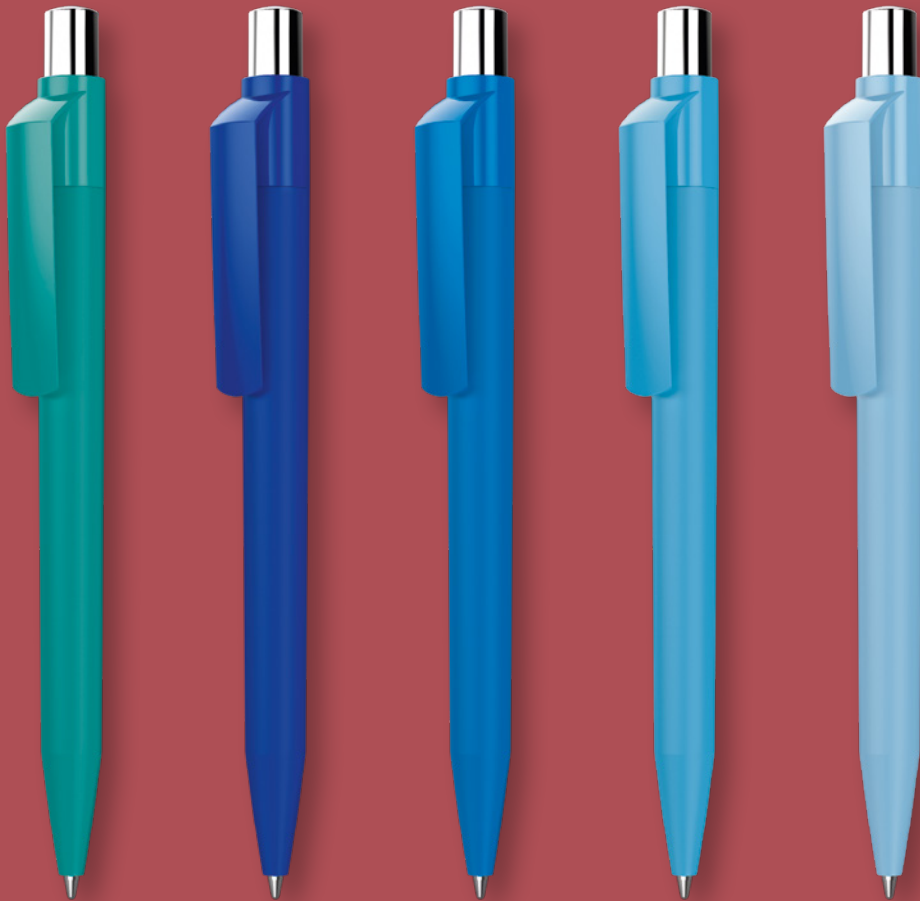

ON TOP
siehe Seite 188-191
see page 188-191

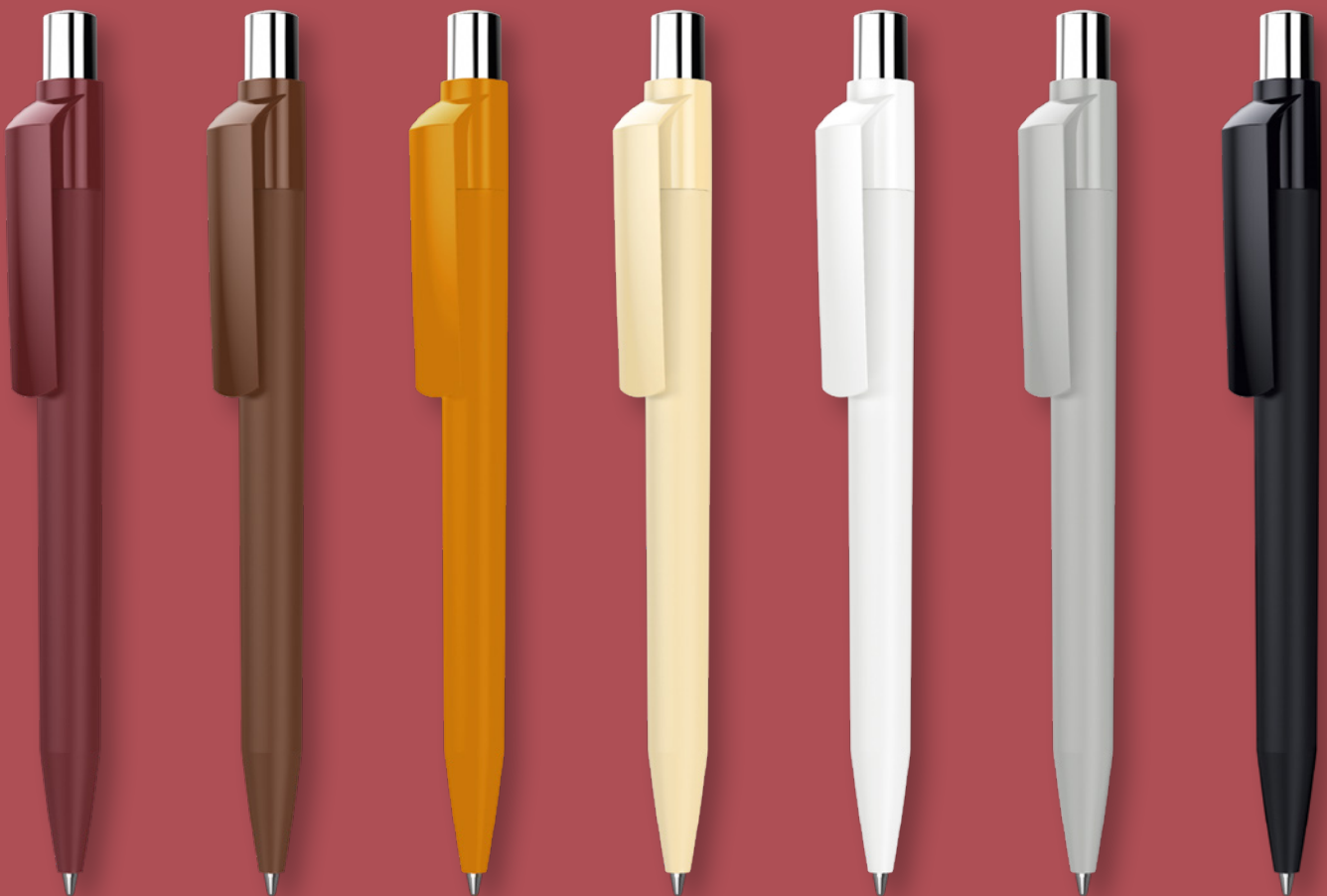



0-0068 SI (● 8-0855)

	32-0292
	32-2175
	32-2147
	32-0200
	32-0382
	32-0348
	32-0343
	32-0002
	32-0428
	32-0001
	32-0115
	32-2705
	32-2685
	32-0188
	32-0203
	32-0213
	32-1585
	32-0638
	32-0321
	32-0469
	● 8-0855

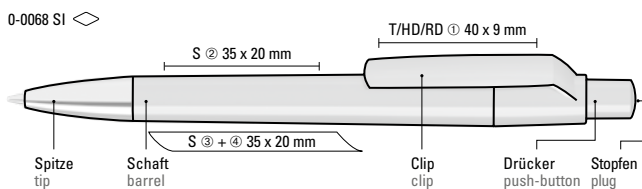

0-0068 SI: Druckkugelschreiber mit gedeckt glänzendem Gehäuse, Clip, Drücker und Stopfen. Spitze glanzverchromt.

0-0068 SI: Retractable ballpoint pen with opaque glossy housing, clip, push-button and plug. Tip chrome plated.

Werbeschlüssel Schaft S, Clip T/HD/RD

Advertising code barrel S, clip T/HD/RD



0-0063 F (● 8-0866)

	32-0292
	32-2175
	32-2147
	32-0200
	32-0382
	32-0348
	32-0343
	32-0002
	32-0428
	32-0001
	32-0115
	32-2705
	32-2685
	32-0188
	32-0203
	32-0213
	32-1585
	32-0638
	32-3262
	32-0321
	32-0468
	32-7569
	32-0469



● 8-0866

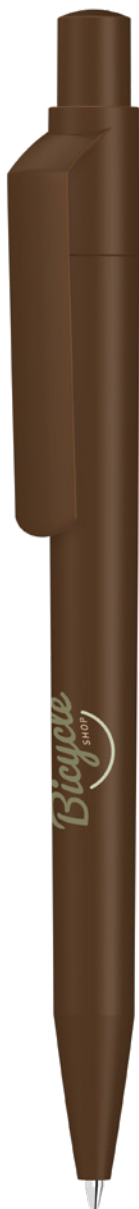

POST-CONSUMER
RECYCLED PLASTIC

Recycelte Variante
ON TOP RECY

Seite/page 70-71



0-0063 F ◀

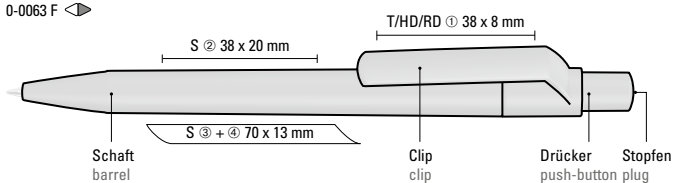

Mix n' Match: Ab 2.000 Stück kann das Modell farblich kombiniert werden.

0-0063 F: Druckkugelschreiber mit gedecktem matten Gehäuse, Clip, Drücker und Stopfen.

Werbeschlüssel

Schaft S ◯,
Clip T/HD/RD

Mix n' Match: From 2,000 pieces, you can choose any colour combination.

0-0063 F: Retractable ballpoint pen with opaque matt housing, clip, push-button and plug.

Advertising code

barrel S ◯,
clip T/HD/RD

ON TOP SI
0-0063 SI

ON TOP SI F
0-0063 SI F

Farb-Code/Minen
Colour code/Refills



0-0063 SI (● 8-0866)

32-0001



0-0063 SI F (● 8-0866)

32-0292



32-2175



32-2147



32-0200



32-0382



32-0348



32-0343



32-0002



32-0428



32-0001



32-0115



32-2705



32-2685



32-0188



32-0203



32-0213



32-1585



32-0638



32-0321



32-0468



32-7569



32-0469



● 8-0866



Mix n' Match: Ab 2.000 Stück kann das Modell farblich kombiniert werden.

0-0063 SI: Druckkugelschreiber mit weiß gedeckt glänzendem Gehäuse, silber glänzendem Drücker und farbigem Stopfen.

0-0063 SI F: Druckkugelschreiber mit farbig gedeckt glänzendem Gehäuse, silber glänzendem Drücker und farbigem Stopfen.

Werbeschlüssel

Schaft S ○,
Clip T/HD/RD

Mix n' Match: From 2,000 pieces, you can choose any colour combination.

0-0063 SI: Retractable ballpoint pen with opaque glossy housing in white, push-button silver glossy and coloured plug.

0-0063 SI F: Retractable ballpoint pen with opaque glossy coloured housing, push-button silver glossy and coloured plug.

Advertising code

barrel S ○,
clip T/HD/RD



0-0063 T-SI (● 8-0866)		0-0063 SI GUM 0-0063 KT-SI GUM* (● 8-0866)	
	32-0286		32-0292
	32-0200		32-2175*
	32-0382		32-7686
	32-2426		32-1805
	32-0419		32-0382
	32-0003		32-0348
	32-0108		32-0343*
	32-2091		32-0002
	32-0213		32-0428*
	32-1585		32-0115
	32-0638		32-2705*
	32-3262		32-2104
	32-7569		32-1817*
	32-0469		32-0203*
	● 8-0866		32-0213
			32-1585
			32-0638
			32-0321
			32-0468*
			32-7569
			32-0469
			● 8-0866

* Farben nicht für
0-0063 KT-SI GUM erhältlich

* Colours not available for
0-0063 KT-SI GUM

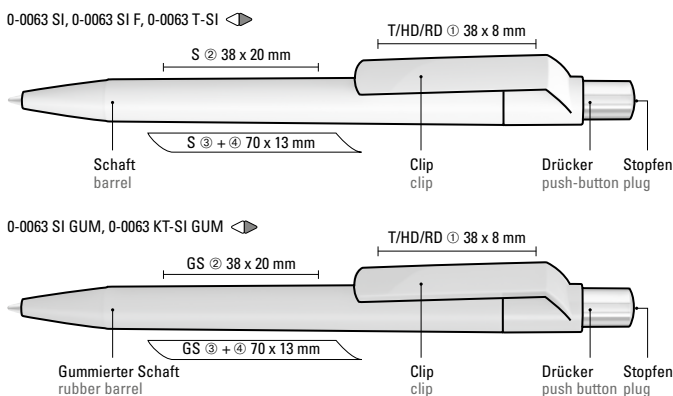

Mix n' Match: Ab 2.000 Stück kann das Modell farblich kombiniert werden.

0-0063 T-SI: Druckkugelschreiber mit transparent glänzendem Gehäuse, silber glänzendem Drücker und farbigem Stopfen.

0-0063 SI GUM: Druckkugelschreiber mit Softtouch-Schaft, gedeckt glänzendem Clip, silber glänzendem Drücker und farbigem Stopfen.

0-0063 KT-SI GUM: Druckkugelschreiber mit Softtouch-Schaft, transparent glänzendem Clip, silber glänzendem Drücker und farbigem Stopfen.

Werbeschlüssel 0-0063 T-SI
Schaft S ○, Clip T/HD/RD
Werbeschlüssel 0-0063 SI GUM
Schaft GS, Clip T/HD/RD
Werbeschlüssel 0-0063 KT-SI GUM
Schaft GS, Clip T/HD/RD

Mix n' Match: From 2,000 pieces, you can choose any colour combination.

0-0063 T-SI: Retractable ballpoint pen with transparent glossy housing, push-button silver glossy and coloured plug.

0-0063 SI GUM: Retractable ballpoint pen with softtouch housing, opaque glossy clip, push-button silver glossy and coloured plug.

0-0063 KT-SI GUM: Retractable ballpoint pen with softtouch housing, transparent glossy clip, push-button silver glossy and coloured plug.

Advertising code 0-0063 T-SI
barrel S ○, clip T/HD/RD
Advertising code 0-0063 SI GUM
barrel GS, clip T/HD/RD
Advertising code 0-0063 KT-SI GUM
barrel GS, clip T/HD/RD

VANE GUM
0-0184 GUM

VANE KG GUM
0-0184 KG GUM

Farb-Code/Minen
Colour code/Refills

VANE



0-0184 GUM (● 8-0866)
0-0184 KG GUM (● 8-0866)

- 32-0292
- 32-2175
- 32-7686
- 32-1805
- 32-0382
- 32-0348
- 32-0343
- 32-0002
- 32-0428
- 32-0115
- 32-2705
- 32-2104
- 32-1817
- 32-0203
- 32-0213
- 32-1585
- 32-0638
- 32-3262
- 32-0321
- 32-0468
- 32-7569
- 32-0469



Mix n' Match: Ab 2.000 Stück kann das Modell farblich kombiniert werden.

0-0184 GUM: Drehkugelschreiber mit Softtouch-Gehäuse und gedeckt glänzendem Clip.

0-0184 KG GUM: Drehkugelschreiber mit Softtouch-Gehäuse und gedeckt glänzendem Clip in weiß.

Werbeschlüssel

Schaft GS,
Clip T/HD/RD

Mix n' Match: From 2,000 pieces, you can choose any colour combination.

0-0184 GUM: Twist ballpoint pen with softtouch housing and opaque glossy clip.

0-0184 KG GUM: Twist ballpoint pen with softtouch housing and opaque glossy clip in white.

Advertising code

barrel GS,
clip T/HD/RD



0-0184 GUM ◀, 0-0184 KG GUM ▶

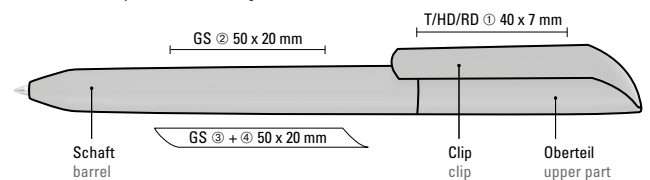

0-0185 SI GUM (● 8-0866)

0-0183 F (● 8-0866)

	32-0292		32-0292
	32-2175		32-2175
	32-7686		32-2147
	32-1805		32-0200
	32-0382		32-0382
	32-0348		32-0348
	32-0343		32-0343
	32-0002		32-0002
	32-0428		32-0428
	32-0115		32-0001
	32-2705		32-0115
	32-2104		32-2705
	32-1817		32-2685
	32-0203		32-0188
	32-0213		32-0203
	32-1585		32-0213
	32-0638		32-1585
	32-3262		32-0638
	32-0321		32-3262
	32-0468		32-0321
	32-7569		32-0468
	32-0469		32-7569
	● 8-0866		32-0469
			● 8-0866



Wabenstruktur im Oberteil
Collar in honeycombed structure



POST-CONSUMER
RECYCLED PLASTIC

Recycelte Variante
VANE RECY
Seite/page 74

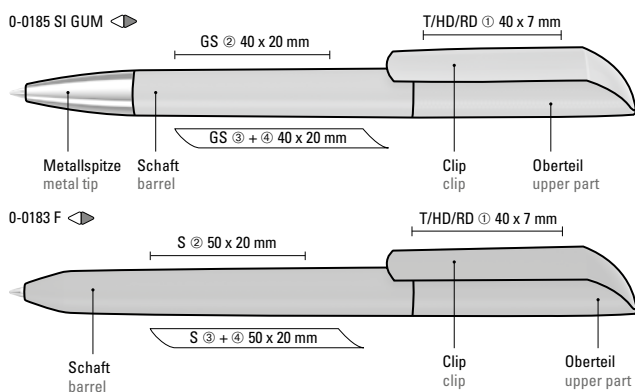

Mix n' Match: Ab 2.000 Stück kann das Modell farblich kombiniert werden.

0-0185 SI GUM: Drehkugelschreiber mit Softtouch-Gehäuse und gedeckt glänzendem Clip, Spitze glanzverchromt.

0-0183 F: Drehkugelschreiber mit gedeckt mattem Gehäuse und Clip.

Werbeschlüssel 0-0185 SI GUM
Schaft GS, Clip T/HD/RD

Werbeschlüssel 0-0183 F
Schaft S, Clip T/HD/RD

Mix n' Match: From 2,000 pieces, you can choose any colour combination.

































0-0185 SI GUM: Twist ballpoint pen with softtouch housing and opaque glossy clip, tip chrome plated.

0-0183 F: Twist ballpoint pen with opaque matt housing and clip.

Advertising code 0-0185 SI GUM
barrel GS, clip T/HD/RD

Advertising code 0-0183 F
barrel S, clip T/HD/RD



0-0071 (● 8-0866)	0-0071 T (● 8-0866)
 32-0292	 32-0286
 32-2175	 32-0200
 32-2147	 32-0382
 32-0200	 32-2426
 32-0382	 32-0419
 32-0348	 32-0003
 32-0343	 32-0108
 32-0002	 32-0254
 32-0428	 32-2091
 32-0001	 32-0213
 32-0115	 32-1585
 32-2705	 32-0638
 32-2685	 32-3262
 32-0188	 32-7569
 32-0203	 32-0469
 32-0213	 32-0866
 32-1585	
 32-0638	
 32-0321	
 32-0468	
 32-7569	
 32-0469	

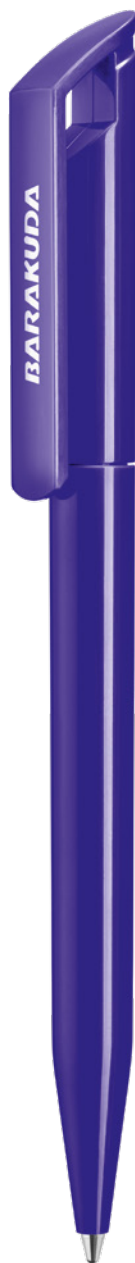

POST-CONSUMER
RECYCLED PLASTIC

Recycelte Variante
POP RECY
Seite/page 75

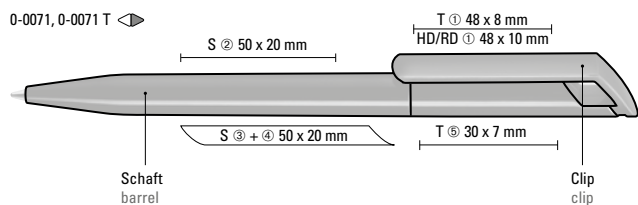

Mix n' Match: Ab 2.000 Stück kann das Modell farblich kombiniert werden.

0-0071: Drehkugelschreiber mit gedeckt glänzendem Gehäuse.

0-0071 T: Drehkugelschreiber mit transparent glänzendem Gehäuse.

Werbeschlüssel Schaft S, Kappe T,
Clip T/HD/RD

Mix n' Match: From 2,000 pieces, you can choose any colour combination.

0-0071: Twist ballpoint pen with opaque glossy housing.

0-0071 T: Twist ballpoint pen with transparent glossy housing.

Advertising code barrel S, cap T,
clip T/HD/RD

EFFECT SI
0-0086 SI

EFFECT F-SI
0-0086 F-SI

Farb-Code/Minen
Colour code/Refills



0-0086 SI (● 8-0866)
0-0086 F-SI (● 8-0866)

- 32-0002
- 32-0001
- 32-0011
- 32-0292
- 32-2175
- 32-2147
- 32-0200
- 32-0382
- 32-0348
- 32-0343
- 32-0115
- 32-2705
- 32-2685
- 32-0188
- 32-0203
- 32-0213
- 32-1585
- 32-0321
- 32-0468
- 32-7569
- 32-0469



Mix n' Match: Ab 2.000 Stück kann das Modell farblich kombiniert werden.

0-0086 SI: Drehkugelschreiber mit gedeckt glänzendem Gehäuse in weiß, farbig glänzendem Stopfen und Spitze glanzverchromt.

0-0086 F-SI: Drehkugelschreiber mit gedeckt mattem Gehäuse in weiß, farbig glänzendem Stopfen und Spitze silber matt.

Werbeschlüssel Schaft S,
Clip S/HD/RD, Stopfen TT









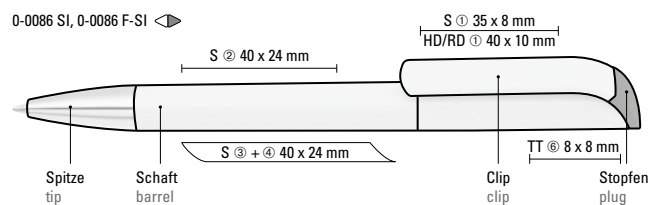

Mix n' Match: From 2,000 pieces, you can choose any colour combination.

0-0086 SI: Twist ballpoint pen with opaque glossy housing in white, coloured plug and tip chrome plated.

0-0086 F-SI: Twist ballpoint pen with opaque matt housing in white, coloured plug and tip silver matt.

Advertising code barrel S,
clip S/HD/RD, plug TT



0-0086 TOP SI (● 8-0866)	0-0086 TOP T-SI (● 8-0866)
 32-0002	 32-0286
 32-0001	 32-0200
 32-0292	 32-2426
 32-2175	 32-0431
 32-2147	 32-0003
 32-0200	 32-0108
 32-0382	 32-0254
 32-0348	 32-2091
 32-0343	 32-1585
 32-0115	 32-3262
 32-2705	 Ultra Jumbo Refill 8-0866
 32-2685	
 32-0188	
 32-0203	
 32-0213	
 32-1585	
 32-0321	
 32-0468	
 32-7569	
 32-0469	
 Ultra Jumbo Refill 8-0866	



0-0086 TOP SI ◀▶ 0-0086 TOP T-SI ◀▶

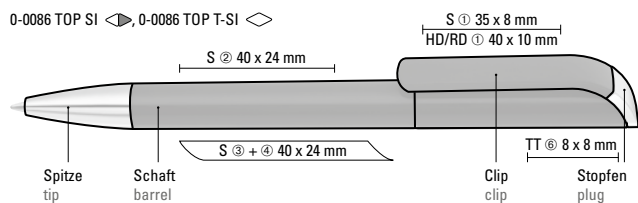

Mix n' Match: Ab 2.000 Stück kann das Modell farblich kombiniert werden.

0-0086 TOP SI: Drehkugelschreiber mit gedeckt glänzendem Gehäuse, Stopfen und Spitze glanzverchromt.

0-0086 TOP T-SI: Drehkugelschreiber mit transparent glänzendem Gehäuse, Stopfen und Spitze glanzverchromt.

Werbeschlüssel Schaft S, Clip S/HD/RD, Stopfen TT

Mix n' Match: From 2,000 pieces, you can choose any colour combination.





















0-0086 TOP SI: Twist ballpoint pen with opaque glossy housing, plug and tip chrome plated.

0-0086 TOP T-SI: Twist ballpoint pen with transparent glossy housing, plug and tip chrome plated.

Advertising code barrel S, clip S/HD/RD, plug TT



0-0057 GUM (● 8-0866)

	32-0292
	32-2175
	32-7686
	32-1805
	32-0382
	32-0348
	32-0343
	32-0002
	32-0428
	32-0115
	32-2705
	32-2104
	32-1817
	32-0203
	32-0213
	32-1585
	32-0638
	32-3262
	32-0321
	32-7569
	32-0469



POST-CONSUMER
RECYCLED PLASTIC

Recycelte Variante
ICONIC RECY
Seite/page 73

0-0057 GUM ◀▶

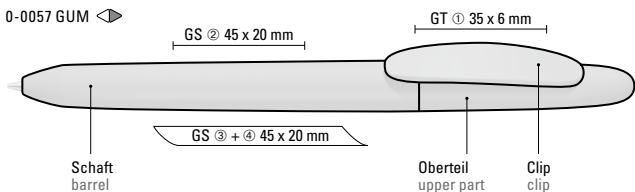

Mix n' Match: Ab 2.000 Stück kann das Modell farblich kombiniert werden.

0-0057 GUM: Drehkugelschreiber mit Softtouch-Gehäuse und Softtouch-Clip.

Werbeschlüssel Schaft GS, Clip GT

Mix n' Match: From 2,000 pieces, you can choose any colour combination.

0-0057 GUM: Twist ballpoint pen with softtouch housing and softtouch clip.

Advertising code barrel GS, clip GT

ICON SI
0-0056 SI

ICON M SI
0-0056 M-SI

Farb-Code/Minen
Colour code/Refills



0-0056 SI (● 8-0866)
0-0056 M-SI (● 8-0866)

- 32-0292
- 32-2175
- 32-2147
- 32-0200
- 32-0382
- 32-0348
- 32-0343
- 32-0002
- 32-0001
- 32-0115
- 32-2705
- 32-2685
- 32-0188
- 32-0203
- 32-0213
- 32-1585
- 32-0321
- 32-0468
- 32-7569
- 32-0469



Mix n' Match: Ab 2.000 Stück kann das Modell farblich kombiniert werden.

0-0056 SI: Drehkugelschreiber mit gedeckt glänzendem Gehäuse und Spitze glanzverchromt.

0-0056 M-SI: Drehkugelschreiber mit gedeckt glänzendem Gehäuse, Metallclip und Spitze glanzverchromt.

Werbeschlüssel 0-0056 SI Schaft S, Clip T

Werbeschlüssel 0-0056 M-SI Schaft S, Clip MT/L

Mix n' Match: From 2,000 pieces, you can choose any colour combination.

0-0056 SI: Twist ballpoint pen with opaque glossy housing and tip chrome plated.

0-0056 M-SI: Twist ballpoint pen with opaque glossy housing, metal clip and tip chrome plated.

Advertising code 0-0056 SI barrel S, clip T

Advertising code 0-0056 M-SI barrel S, clip MT/L

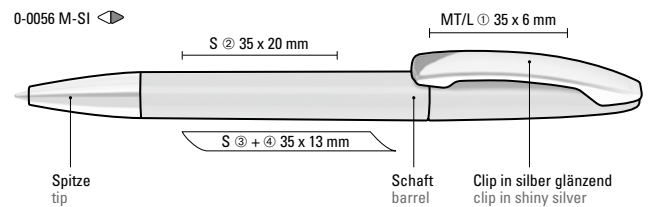
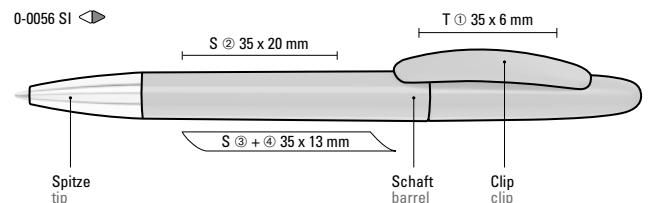

0-0056 M-SI GUM (● 8-0866)

	32-0292
	32-2175
	32-7686
	32-1805
	32-0382
	32-0348
	32-0343
	32-0002
	32-0115
	32-2705
	32-2104
	32-1817
	32-0203
	32-0213
	32-1585
	32-0321
	32-0468
	32-7569
	32-0469

Umid Jumbo Refill 8.0866 ● 8-0866



0-0056 M-SI GUM ◀

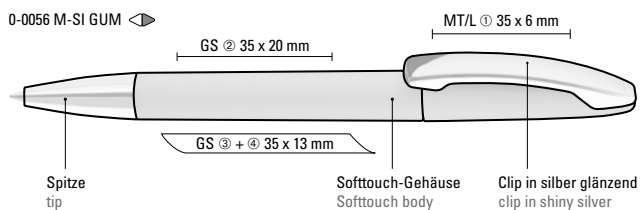

Mix n' Match: Ab 2.000 Stück kann das Modell farblich kombiniert werden.

0-0056 M-SI GUM: Drehkugelschreiber mit Softtouch-Gehäuse, Metallclip und Spitze glanzverchromt.









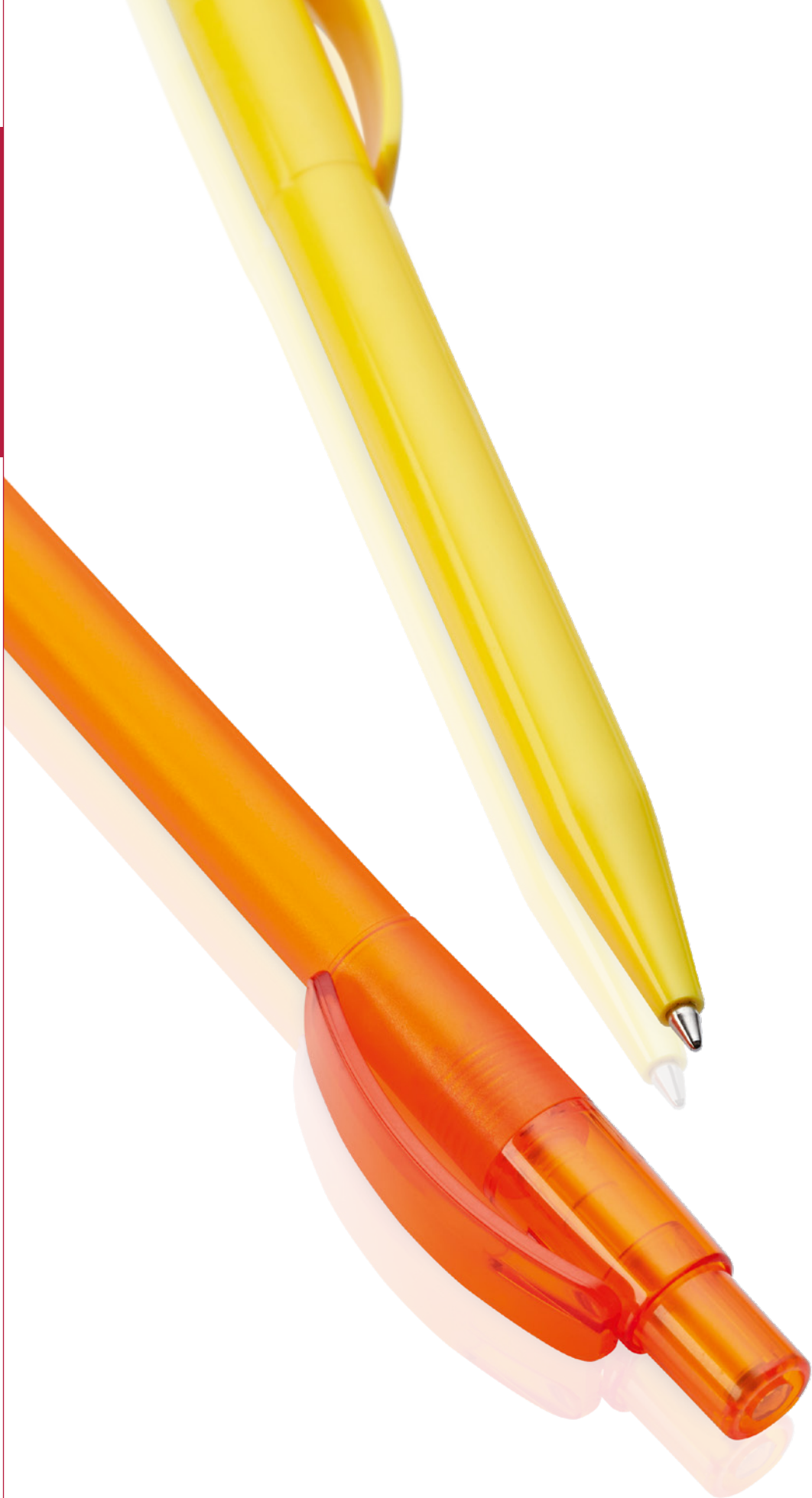























Werbeschlüssel Schaft GS, Clip MT/L

Mix n' Match: From 2,000 pieces, you can choose any colour combination.

0-0056 M-SI GUM: Twist ballpoint pen with softtouch housing, metal clip and tip chrome plated.

Advertising code barrel GS, clip MT/L



0-0017 (● 8-0866)		0-0017 TF (● 8-0866)	
	32-2175		32-2915
	32-2147		32-0286
	32-0200		32-0200
	32-0348		32-0382
	32-0343		32-2426
	32-0002		32-0419
	32-0001		32-0431
	32-0115		32-0003
	32-0188		32-0108
	32-1585		32-2655
	32-0468		32-0254
	● 8-0866		32-2091
			32-1765
			32-0213
			32-1585
			32-0638
			32-3262
			32-7569
			32-0469
			● 8-0866

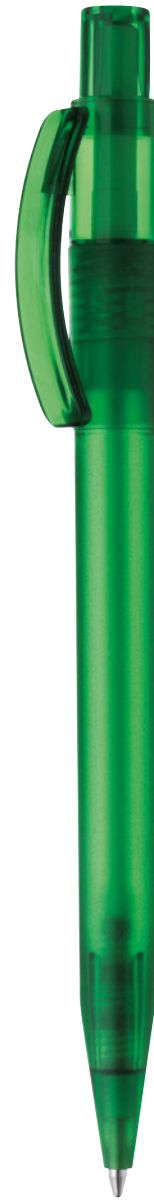

POST-CONSUMER
RECYCLED PLASTIC

Recycelte Variante
PIXEL RECY

Seite/page 76

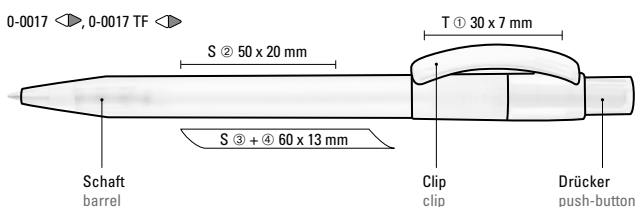

Mix n' Match: Ab 2.000 Stück kann das Modell farblich kombiniert werden.

0-0017: Druckkugelschreiber mit gedeckt glänzendem Gehäuse, Bogenclip und Drücker.

0-0017 TF: Druckkugelschreiber mit gefrostetem Gehäuse, glänzend transparentem Bogenclip und Drücker.

Werbeschlüssel Schaft S ○, Clip T

Mix n' Match: From 2,000 pieces, you can choose any colour combination.

0-0017: Retractable ballpoint pen with opaque glossy housing, curved clip and push-button.

0-0017 TF: Retractable ballpoint pen with transparent frosted housing, transparent glossy curved clip and push-button.

Advertising code barrel S ○, clip T



0-0045 (● 8-0866)

0-0045 SI (● 8-0866)

	32-2175		32-2175
	32-2147		32-2147
	32-0200		32-0200
	32-0348		32-0348
	32-0343		32-0343
	32-0002		32-0002
	32-0115		32-0001
	32-2617		32-0115
	32-0188		32-2617
	32-1585		32-0188
	32-0321		32-1585
	32-0321		32-0321
	32-0468		32-0468

● 8-0866

Kombinationsbeispiele
Examples of combinations

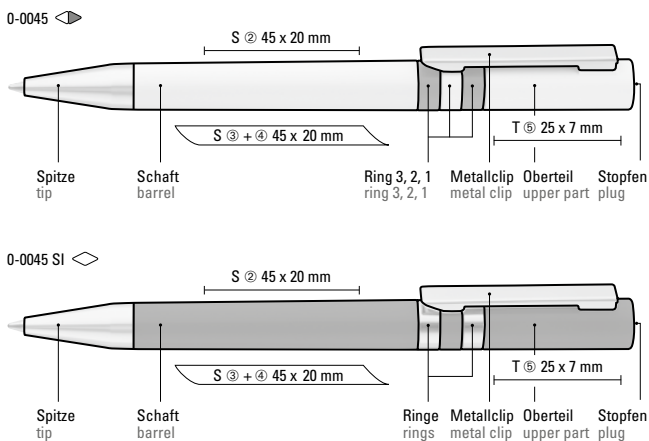

Mix n' Match: Ab 2.000 Stück kann das Modell farblich kombiniert werden.

0-0045: Drehkugelschreiber mit gedeckt glänzendem Gehäuse in weiß, farbig eingelassene Ringe und Stopfen im Oberteil. Metallclip und Spitze in silber glänzend.

0-0045 SI: Drehkugelschreiber mit gedeckt glänzendem Gehäuse. Eingelassene Ringe, Stopfen im Oberteil, Metallclip und Spitze in silber glänzend.

Werbeschlüssel Schaft S, Kappe T

Mix n' Match: From 2,000 pieces, you can choose any colour combination.

0-0045: Twist ballpoint pen with opaque glossy housing in white, coloured rings and plug. Metal clip and tip silver glossy.

0-0045 SI: Twist ballpoint pen with opaque glossy housing. Rings, plug, metal clip and tip silver glossy.

Advertising code barrel S, cap T



VIANI
1-0735

TORSION
1-0690

Farb-Code/Minen
Colour code/Refills



1-0735 (●● 8-0877)
1-0690 (●● 8-0855)



Mix n' Match: Alle Teile können farblich frei kombiniert werden.

1-0735: Druckkugelschreiber mit gedeckt glänzendem Gehäuse und großem Clip an genoppter Clipaufhängung.

1-0690: Druckkugelschreiber mit gedeckt glänzendem Gehäuse, vernickeltem Metallbiegeclip und Metallspitze.

Mix n' Match: All parts can be colour-combined freely.

1-0735: Retractable ballpoint pen with opaque glossy housing and large clip on nubbed clip holder.

1-0690: Retractable ballpoint pen with opaque glossy housing, nickel-plated flexible metal clip and metal tip silver glossy.

Werbeschlüssel 1-0735 Schaft S ○, Clip S

Werbeschlüssel 1-0690 Schaft S ○

Advertising code 1-0735 barrel S ○, clip S

Advertising code 1-0690 barrel S ○

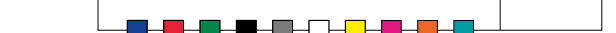
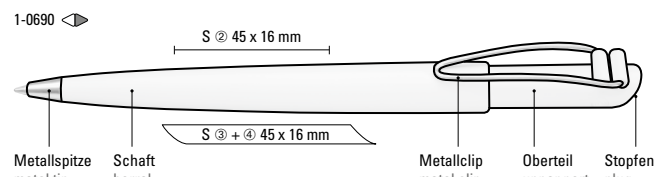
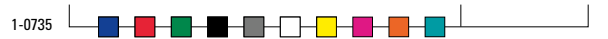
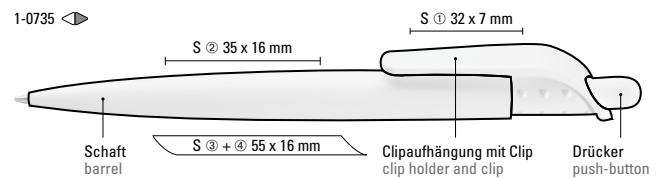

6-2860 G (●●8-0866)
6-2861 G (●●8-0866)

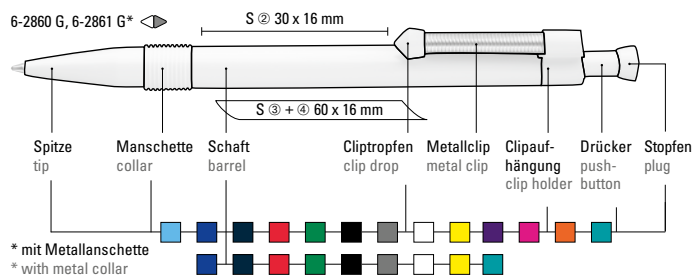

Mix n' Match: Alle Teile können farblich frei kombiniert werden.

6-2860 G: Druckkugelschreiber mit gedecktem Gehäuse und flexiblem und vernickeltem Metallfederclip.

6-2861 G: Druckkugelschreiber wie 6-2860 G, jedoch mit Metallmanschette als Griffzone.

Werbeschlüssel

Schaft S ⊙

Mix n' Match: All parts can be colour-combined freely.

6-2860 G: Retractable ballpoint pen with flexible, nickel-plated springy metal clip.

6-2861 G: Retractable ballpoint pen like 6-2860 G, but with metal-collar grip zone.

Advertising code

barrel S ⊙

ALL MET
AL MET

TA
M



LL METALL METALL METALL METALL
METAL METAL METAL METAL



MOOD GUM
0-9340 GUMMOOD R GUM
0-9342 R GUMFarb-Code/Minen
Colour code/Refills

0-9340 GUM (● 8-0888)

66-0002



● 8-0888

0-9342 R GUM (● ● 8-0806)

66-0002



● ● 8-0806



Die Modelle eignen sich für eine Hochglanzlasergravur in Silber. Siehe Seite 305.

The models are suitable for high gloss laser engraving in silver. See page 305.



Etui Empfehlung/Case suggestion
ETUI 0-0918

Beschreibung auf Seite 287
See description on page 287

0-9340 GUM: Metall-Drehkugelschreiber mit Softtouch-Gehäuse, Softdrehmechanik und gefedertem Metallclip. Beschlagteile schwarz glänzend lackiert.

0-9342 R GUM: Metall-Rollerball mit Softtouch-Gehäuse und gefedertem Metallclip. Beschlagteile schwarz glänzend lackiert.

Werbeschlüssel 0-9340 GUM

Schaft GT/L,
Oberteil GT/L

Werbeschlüssel 0-9342 R GUM

Schaft GT/L,
Kappe GT/L

0-9340 GUM: Metal twist ballpoint pen with softtouch housing, soft twist mechanism and a spring-mounted metal clip. Fittings glossy black.

0-9342 R GUM: Metal rollerball with softtouch housing and spring-mounted metal clip. Fittings glossy black.

Advertising code 0-9340 GUM

barrel GT/L,
upper part GT/L

Advertising code 0-9342 R GUM

barrel GT/L,
cap GT/L

0-9340 GUM ◇

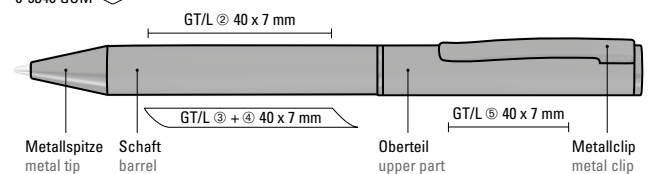

0-9342 R GUM ◇

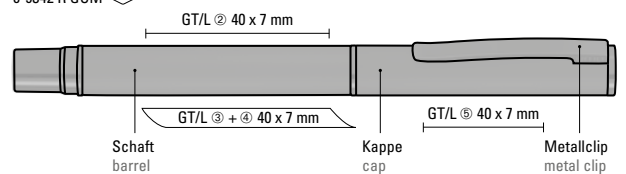

0-9340 C (● 8-0888)



66-CAR3



● 8-0888

0-9342 R C (●● 8-0806)



54-0002



●● 8-0806



Die Modelle eignen sich für eine Hochglanzlasergravur in Silber. Siehe Seite 305.

The models are suitable for high gloss laser engraving in silver. See page 305.



Etui Empfehlung/Case suggestion

ETUI 0-0913

Beschreibung auf Seite 288

See description on page 288



0-9340 C ◊

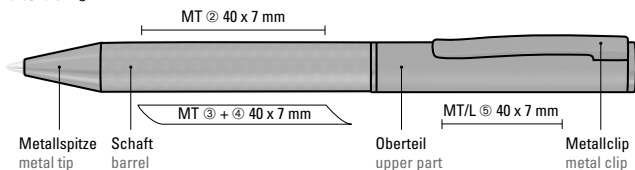

0-9340 C: Metall-Drehkugelschreiber mit Schaft aus Carbonfaser in schwarz, Softdrehmechanik und gefedertem Metallclip. Beschlagteile schwarz matt lackiert.

0-9340 C: Metal twist ballpoint pen with carbon fibre in black, soft twist mechanism and a spring-mounted metal clip. Fittings black matt.

0-9342 R C ◊

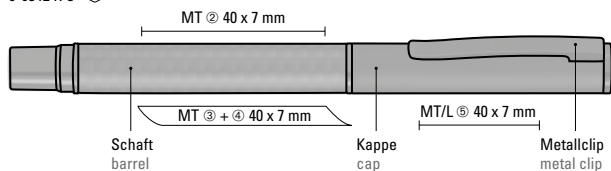

0-9342 R C: Metall-Rollerball mit Schaft aus Carbonfaser in schwarz und gefedertem Metallclip. Beschlagteile schwarz matt lackiert.

0-9342 R C: Metal rollerball with carbon fibre barrel in black and spring-mounted metal clip. Fittings black matt.

Werbeschlüssel 0-9340 C Schaft MT, Oberteil MT/L

Advertising code 0-9340 C barrel MT, upper part MT/L

Werbeschlüssel 0-9342 R C Schaft MT, Kappe MT/L

Advertising code 0-9342 R C barrel MT, cap MT/L



0-9350 (● 8-0888)



0-9352 R (● ● 8-0806)



Das Modell in schwarz eignet sich für eine Hochglanzlasergravur in silber. Siehe Seite 304.

The model in black is suitable for high gloss laser engraving in silver. See page 304.



Die Modelle in silber und GUN eignen sich für eine Lasergravur in beige. Siehe Seite 304.

The models in silver and GUN are suitable for laser engraving in beige. See page 304.



0-9350 ◊

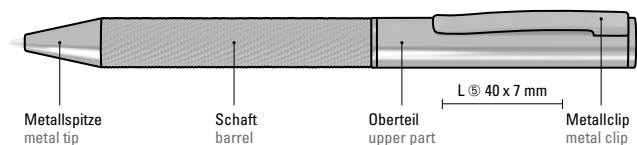

0-9350: Metall-Drehkugelschreiber glänzend lackiert mit Softdrehmechanik und gefedertem Metallclip. Schaft mit integriertem Meshband.

0-9350: Metal twist ballpoint pen in glossy lacquered finish with a soft twist mechanism and a spring-mounted metal clip. Barrel with integrated mesh band.

0-9352 R ◊

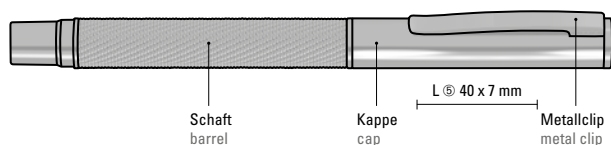

0-9352 R: Metall-Rollerball glänzend lackiert mit gefedertem Metallclip und Schaft mit integriertem Meshband.

0-9352 R: Metal rollerball in glossy lacquered finish with spring-mounted metal clip and barrel with integrated mesh band.

Werbeschlüssel 0-9350
Werbeschlüssel 0-9352 R

Oberteil L
Kappe L

Advertising code 0-9350 upper part L
Advertising code 0-9352 R cap L



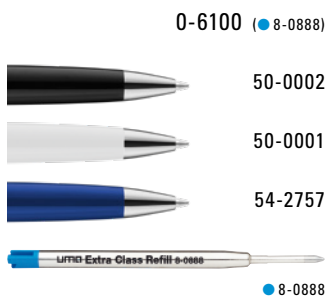

Das Modell eignet sich für eine Hochglanzlasergravur in Silber. Siehe Seite 304.

The model is suitable for high gloss laser engraving in silver. See page 304.



Die Modelle eignen sich für Rundumlasergravur.

The models are suitable for 360° laser engraving.

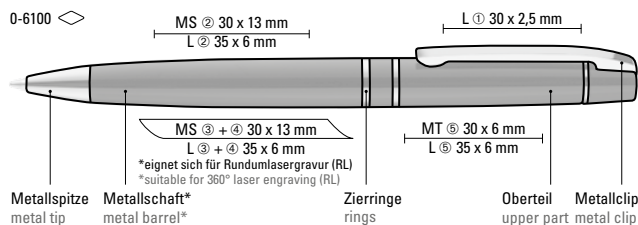

0-6100: Schlanker Metall-Drehkugelschreiber mit Softdrehmechanik und gefedertem Clip. Beschlagteile glanzverchromt.

Werbeschlüssel Schaft MS/L/RL, Clip L, Oberteil MT/L

0-6100: Slim metal twist ballpoint pen with soft twist mechanism and spring-mounted clip. Metal fittings chrome plated.

Advertising code barrel MS/L/RL, clip L, upper part MT/L

VIP GUM
0-9100 GUM

VIP R GUM
0-9102 R GUM

Farb-Code/Minen
Colour code/Refills



0-9100 GUM (● 8-0888)
0-9102 R GUM (●● 8-0806)



VIP GUM – umaPMS-SERVICE
Customer CI Samples: **new!**



Die edle Schreibgeräte-Serie uma VIP GUM bereits ab 500 Stück im CI gerechten Kundendesign! Der umaPMS-Service für noch mehr Individualität. Die nach PMS eingefärbten gummierten Oberflächen treffen auf zeitlose schwarze Beschläge. Einen besonderen zusätzlichen Werbeakzent setzt die schwarz glänzende Gravur für Kundenlogos oder Einzelnamen. Preis auf Anfrage!

The premium writing instrument series uma VIP GUM, available from just 500 pieces in custom CI-compliant design! The umaPMS-service for even greater individuality. The PMS-coloured rubberized surfaces are paired with timeless black fittings. A special advertising highlight is created by the glossy black engraving for customer logos or individual names. Price on request!



Etui Empfehlung/Case suggestion
ETUI 0-0913
Beschreibung auf Seite 288
See description on page 288



Die Modelle in beige, braun und Sonderfarben eignen sich für eine Lasergravur in schwarz. Siehe Seite 304.
The models in beige, brown and special colours are suitable for laser engraving in black. See page 304.



Die Modelle in schwarz eignen sich für eine Hochglanzlasergravur in silber. Siehe Seite 304.
The models in black are suitable for high gloss laser engraving in silver. See page 304.

0-9100 GUM: Metall-Drehkugelschreiber mit Softtouch-Gehäuse, Softdrehmechanik und gefedertem Clip. Beschlagteile schwarz glänzend lackiert.
0-9102 R GUM: Metall-Rollerball mit Softtouch-Gehäuse, gefedertem Clip und schwarzer Gummigriffzone. Beschlagteile schwarz glänzend lackiert.
Werbeschlüssel 0-9100 GUM
Schaft GT/L, Oberteil GT/L
Werbeschlüssel 0-9102 R GUM
Schaft GT/L, Kappe GT/L

0-9100 GUM: Metal twist ballpoint pen with softtouch housing, soft twist mechanism and spring-mounted clip. Fittings glossy black.
0-9102 R GUM: Metal rollerball with softtouch housing, spring-mounted clip and black grip zone. Fittings glossy black.
Advertising code 0-9100 GUM
barrel GT/L, upper part GT/L
Advertising code 0-9102 R GUM
barrel GT/L, cap GT/L

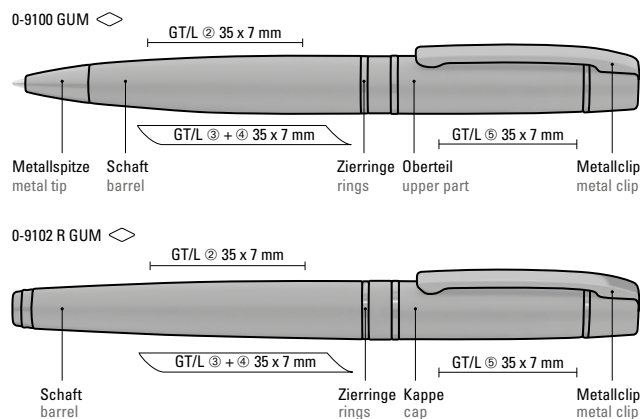

0-9100 (● 8-0888)
0-9102 R (● 8-0806)

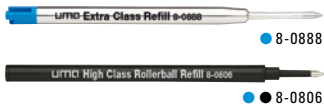
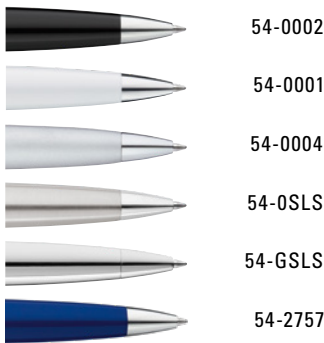

0-9100 GO (● 8-0888)



0-9106 F (● 8-0891)



0-9107 B (0,7 mm)



Die Modelle eignen sich für Rundumlasergravur.
The models are suitable for 360° laser engraving.

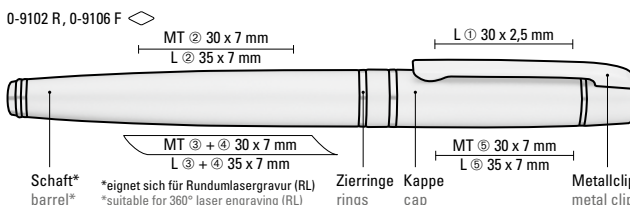
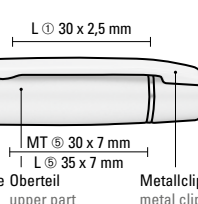

0-9100: Metall-Drehkugelschreiber mit Softdrehmechanik und gefedertem Clip. Beschlagteile glanzverchromt.

0-9100 GO: Metall-Drehkugelschreiber mit Softdrehmechanik und gefedertem Clip. Beschlagteile vergoldet.

0-9102 R: Metall-Rollerball mit gefedertem Clip und schwarzer Gummigriffzone. Beschlagteile glanzverchromt.

0-9106 F: Metall-Füllfederhalter mit Iridiumfeder und gefedertem Clip. Beschlagteile glanzverchromt.

0-9107 B: Metall-Drehbleistift (0,7mm) mit gefedertem Clip. Beschlagteile glanzverchromt.

Werbeschlüssel
0-9100, 0-9100 GO, 0-9107 B
Schaft MS/L/RL
Clip L, Oberteil MT/L

Werbeschlüssel 0-9102 R, 0-9106 F
Schaft MT/L/RL,
Clip L, Kappe MT/L

0-9100: Metal twist ballpoint pen with soft twist mechanism and spring-mounted clip. Fittings chrome plated.

0-9100 GO: Metal twist ballpoint pen with soft twist mechanism and spring-mounted clip. Fittings gold plated.

0-9102 R: Metal rollerball with spring-mounted clip and black grip zone. Fittings chrome plated.

0-9106 F: Metal fountain pen with iridium fountain and spring-mounted clip. Fittings chrome plated.

0-9107 B: Metal twist pencil (0.7mm) with soft twist mechanism and spring-mounted clip. Fittings chrome plated.

Advertising code
0-9100, 0-9100 GO, 0-9107 B
barrel MS/L/RL,
clip L, upper part MT/L

Advertising code 0-9102 R, 0-9106 F
barrel MT/L/RL,
clip L, cap MT/L

TITAN ONE M
0-9360 M **new!**

TITAN ONE MR
0-9362 MR **new!**

Farb-Code/Minen
Colour code/Refills



0-9360 M (● 8-0888)

52-0002



52-4239



52-6033



● 8-0888

0-9362 MR (● ● 8-0806)

52-0002



52-4239



52-6033



● ● 8-0806



Die Modelle in schwarz eignen sich für eine Hochglanzlasergravur in silber. Siehe Seite 304.

The models are suitable for high gloss laser engraving in silver. See page 304.

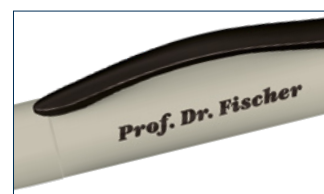

Die Modelle in beige und braun eignen sich für eine Lasergravur in schwarz. Siehe Seite 304.

The models in beige and brown are suitable for laser engraving in black. See page 304.

0-9360 M: Metall-Drehkugelschreiber mit matt lackiertem Gehäuse, Softdrehmechanik und gefedertem Clip in schwarz matt.

0-9362 MR: Metall-Rollerball mit matt lackiertem Gehäuse und gefedertem Clip in schwarz matt.

Werbeschlüssel 0-9360 M Schaft MT/L, Oberteil MT/L

Werbeschlüssel 0-9362 MR Schaft MT/L, Kappe MT/L

0-9360 M: Metal twist ballpoint pen with matt lacquered housing, soft twist mechanism and spring-mounted metal clip in matt black.

0-9362 MR: Metal rollerball with matt lacquered housing and spring-mounted metal clip in matt black.

Advertising code 0-9360 M barrel MT/L, upper part MT/L

Advertising code 0-9362 MR barrel MT/L, cap MT/L

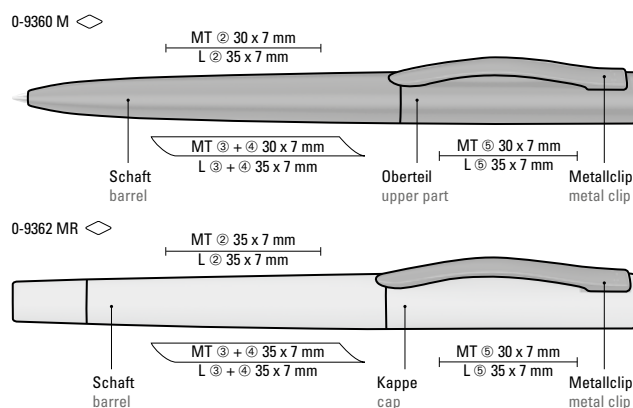

0-9360 (● 8-0888)



0-9362 R (● 8-0806)

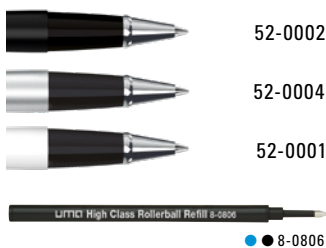

Die Modelle in schwarz eignen sich für eine Hochglanzlasergravur in silber. Siehe Seite 304.

The models are suitable for high gloss laser engraving in silver. See page 304.



Etui Empfehlung/Case suggestion

Metall ETUI ML 0-0962 ML

Beschreibung auf Seite 289

See description on page 289



Holzvariante/wooden version
TITAN WOOD
Seite/page 89

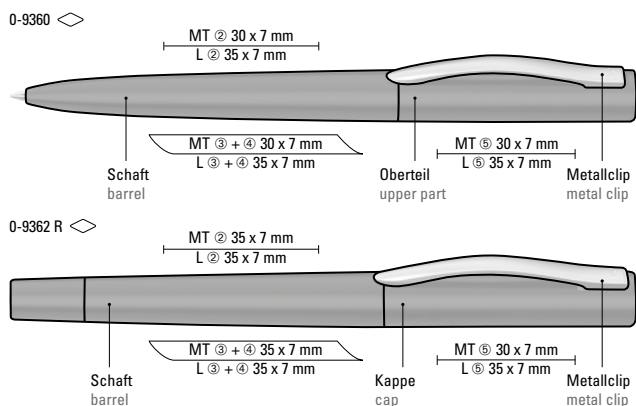

0-9360: Metall-Drehkugelschreiber mit matt lackiertem Gehäuse, Softdrehmechanik und gefedertem, gebürstetem Clip.

0-9362 R: Metall-Rollerball mit matt lackiertem Gehäuse, gefedertem, gebürstetem Clip.

Werbeschlüssel 0-9360

Schaft MT/L,
Oberteil MT/L

Werbeschlüssel 0-9362 R

Schaft MT/L,
Kappe MT/L

0-9360: Metal twist ballpoint pen with matt lacquered housing, soft twist mechanism and spring-mounted metal clip brush-finished.

0-9362 R: Metal rollerball with matt lacquered housing, spring-mounted metal clip brush-finished.

Advertising code 0-9360

barrel MT/L,
upper part MT/L

Advertising code 0-9362 R

barrel MT/L,
cap MT/L

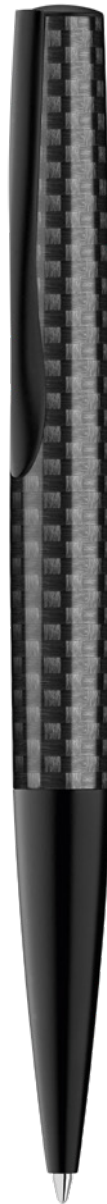
ELEGANCE LUX
0-9190 LUXELEGANCE C
0-9190 CFarb-Code/Minen
Colour code/Refills

0-9190 LUX (● 8-0888)

53-00G0



0-9190 C (● 8-0888)

53-CAR2



53-CAR4



53-CAR3



● 8-0888

Holzvariante/wooden version
ELEGANCE WOOD
Seite/page 90-91

0-9190 LUX: Metall-Drehkugelschreiber mit 18 ct vergoldetem Gehäuse, gefederter Metallclip, schwere Metallspitze und Softdrehmechanik.

0-9190 C: Metall-Drehkugelschreiber mit Schaft aus Carbonfaser in schwarz oder silber, gefederter Metallclip und schwere Metallspitze glanzverchromt bzw. Schaft aus Carbonfaser in schwarz, Metallclip und schwere Metallspitze schwarz matt lackiert und Softdrehmechanik.

Werbeschlüssel 0-9190 LUX
Schaft L, Stopfen L

Werbeschlüssel 0-9190 C
Schaft MS, Stopfen L

0-9190 LUX: Metal twist ballpoint pen with 18 ct gold plated housing, spring-mounted metal clip, heavy metal tip and soft twist mechanism.

0-9190 C: Metal twist ballpoint pen with carbon fibre barrel in black or silver, spring-mounted metal clip and glossy chrome plated tip or black carbon fibre barrel, spring-mounted metal clip and metal tip in black matt and soft twist mechanism.

Advertising code 0-9190 LUX
barrel L, plug L

Advertising code 0-9190 C
barrel MS, plug L

0-9190 LUX ◊

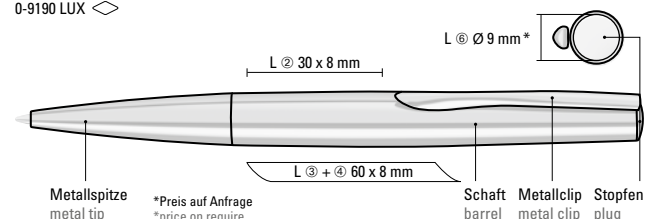

0-9190 C ◊

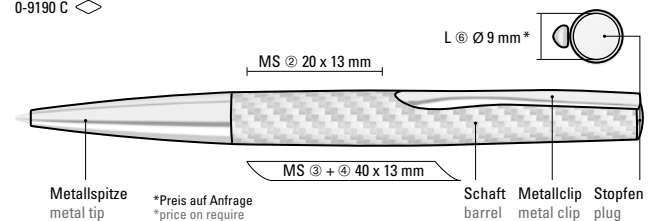

Farb-Code/Minen
Colour code/Refills

ELEGANCE
0-9190

ELEGANCE M
0-9190 M

ELEGANCE GO
0-9190 GO

221



Das Modell 0-9190 GO eignet sich für eine Lasergravur in gold.
Siehe Seite 304.

The model 0-9190 GO is suitable for laser engraving in gold.
See page 304.



Die Modelle eignen sich für eine Hochglanzlasergravur in silber.
Siehe Seite 304.

The models are suitable for high gloss laser engraving in silver.
See page 304.



Etui Empfehlung / Case suggestion

Metalletui 0-0962 ML

Beschreibung auf Seite 289

See description on page 289

0-9190, 0-9190 M, 0-9190 GO

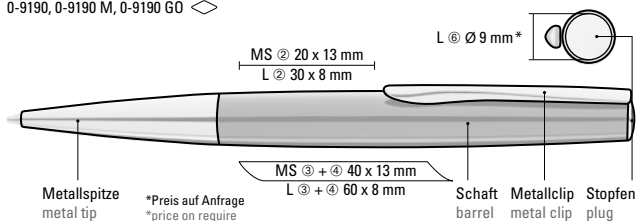

0-9190: Metall-Drehkugelschreiber mit gedeckt glänzendem Schaft in schwarz oder weiß, gefederter Metallclip, Stopfen, schwere Metallspitze glanzverchromt und Softdrehmechanik.

0-9190 M: Metall-Drehkugelschreiber mit gedeckt matt lackiertem Gehäuse in schwarz, gefederter Metallclip, Stopfen und schwere Metallspitze und Softdrehmechanik.

0-9190 GO: Metall-Drehkugelschreiber mit gedeckt mattem Schaft in schwarz, gefederter Metallclip, Stopfen und schwere Metallspitze in matt vergoldet und Softdrehmechanik.

0-9190: Metal twist ballpoint pen with opaque glossy housing in black or white, spring-mounted metal clip, plug, heavy metal tip chrome plated and soft twist mechanism.

0-9190 M: Metal twist ballpoint pen with matt lacquered housing in black, spring-mounted metal clip, plug, heavy metal tip and soft twist mechanism.

0-9190 GO: Metal twist ballpoint pen with opaque matt housing in black, spring-mounted metal clip, plug, heavy metal tip matt gold plated and soft twist mechanism.

Werbeschlüssel

Schaft MS/L,
Stopfen L

Advertising code

barrel MS/L,
plug L

GALILEO C
0-8940 C

NOBILIS
0-8900

NOBILIS B
0-8907 B

Farb-Code/Minen
Colour code/Refills

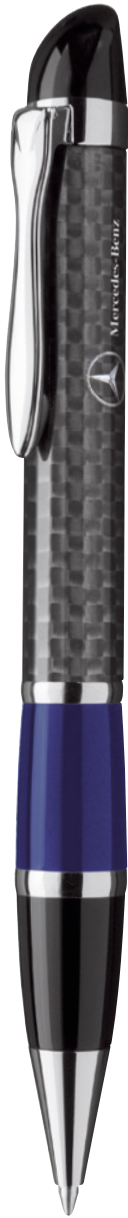

0-8940 C (● 8-0888)

61-0002



0-8900 (● 8-0888)

0-8907 B (0,7mm)

52-2756



52-0187



52-0376



52-0349



52-0002



52-0137



52-2603



52-0234



52-0021



● 8-0888



Die Modelle eignen sich für eine Hochglanzlasergravur in Silber. Siehe Seite 304.

The models are suitable for high gloss laser engraving in silver. See page 304.

0-8940 C: Carbonfaser Metalldrehkugelschreiber mit zwei eingelassenen silbernen Ringen und Kappe in schwarz. Metallbeschlagteile glanzverchromt.

0-8900: Edler Carbonfaser Metalldrehkugelschreiber mit farbiger Griffzone, flexiblem Metallclip, Metallzierring und Metallspitze glanzverchromt.

0-8907 B: Edler Carbonfaser Metalldrehbleistift (0,7mm) mit farbiger Griffzone, flexiblem Metallclip, Metallzierring und Metallspitze glanzverchromt.

Werbeschlüssel 0-8940 C Schaft MS, Kappe MT/L

Werbeschlüssel 0-8900 Schaft MS

Werbeschlüssel 0-8907 B Schaft MS

0-8940 C: Carbon fibre metal twist ballpoint pen with two recessed silver rings and cap in black. Metal fittings chrome plated.

0-8900: Carbon fibre metal twist ballpoint pen with coloured grip zone, flexible metal clip, metal ring and metal tip chrome plated.

0-8907 B: Carbon fibre metal twist pencil (0.7mm) with coloured grip zone, flexible metal clip, metal ring and metal tip chrome plated.

Advertising code 0-8940 C barrel MS, cap MT/L

Advertising code 0-8900 barrel MS

Advertising code 0-8907 B barrel MS

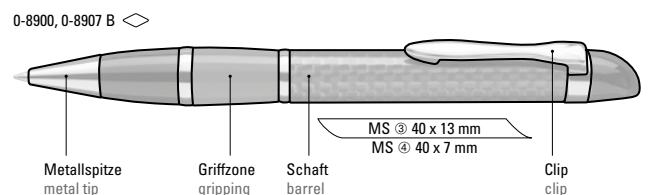
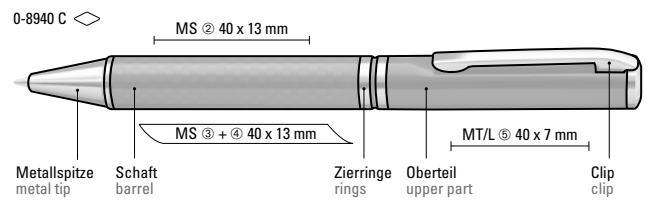

0-8370 (●● 8-0856)
0-8372 R (●● 8-0806)



0-8370 M (●● 8-0856)
0-8372 MR (●● 8-0806)



Die Modelle eignen sich für eine Hochglanzlasergravur in Silber.
Siehe Seite 304.

The models are suitable for high gloss laser engraving in silver.
See page 304.



0-8370, 0-8370 M ◊

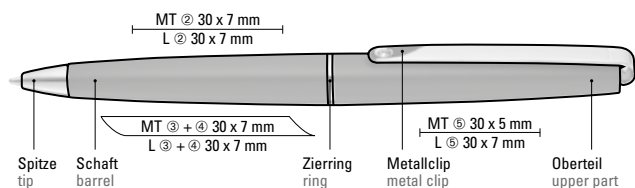

0-8372 R, 0-8372 MR ◊

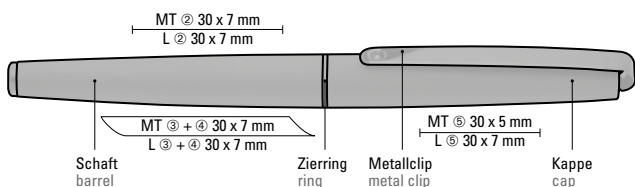

0-8370: Metall-Drehkugelschreiber mit Softdrehmechanik und glänzendem Gehäuse. Langer flexibler Metallclip, Zierring und Spitze glanzverchromt.

0-8372 R: Metall-Rollerball mit glänzendem Gehäuse. Langer flexibler Metallclip, Zierring und Stopfen glanzverchromt. Griffzone gerillt glanzverchromt.

0-8370 M: Metall-Drehkugelschreiber mit Softdrehmechanik und matt lackiertem Gehäuse. Langer flexibler Metallclip, Zierring und Spitze schwarz glänzend.

0-8372 MR: Metall-Rollerball mit matt lackiertem Gehäuse. Langer flexibler Metallclip, Zierring und Stopfen schwarz glänzend. Griffzone gerillt schwarz glänzend.

0-8370: Metal twist ballpoint pen with soft twist mechanism, glossy housing. Long, flexible metal clip, ring and tip chrome plated.

0-8372 R: Metal rollerball with glossy housing. Long, flexible metal clip, ring and plug chrome plated. Ribbed grip zone chrome plated.

0-8370 M: Metal twist ballpoint pen with soft twist mechanism, matt lacquered housing. Long, flexible metal clip, ring and tip glossy black.

0-8372 MR: Metal rollerball with matt lacquered housing. Long, flexible metal clip, ring and plug glossy black. Ribbed grip zone glossy black.

Werbeschlüssel

Schaft MT/L,
Kappe MT/L

Advertising code

barrel MT/L,
cap MT/L



0-9940 (● 8-0888)
0-9942 R (● 8-0806)

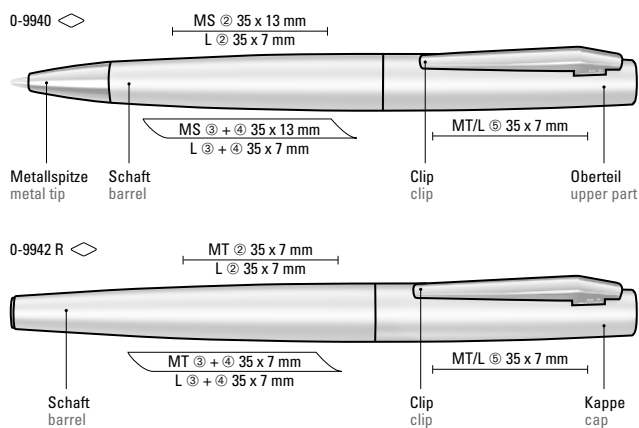
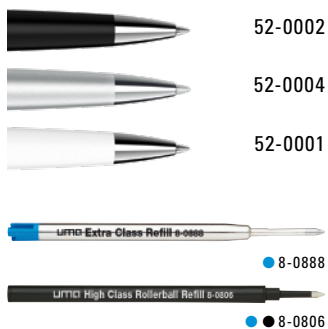

0-9940: Metall-Drehkugelschreiber mit matt lackiertem Gehäuse und Softdrehmechanik. Metallclip, Metallspitze und Stopfen glanzverchromt.

0-9942 R: Metall-Rollerball mit matt lackiertem Gehäuse. Metallclip und Stopfen glanzverchromt.

Werbeschlüssel 0-9940 Schaft MS/L, Oberteil MT/L

Werbeschlüssel 0-9942 R Schaft MT/L, Kappe MT/L

0-9940: Metal twist ballpoint pen with matt lacquered housing and soft twist mechanism. Metal clip, metal tip and plug chrome plated.

0-9942 R: Metal rollerball with matt lacquered housing. Metal clip and plug chrome plated.

Advertising code 0-9940 barrel MS/L, upper part MT/L

Advertising code 0-9942 R barrel MT/L, cap MT/L



0-8800 M (● 8-0883)

53-0002

LITMIL Economy Class Refill 0-0883

● 8-0883

Das Modell eignet sich für
Lasergravur in gold. Siehe Seite 304.The model is suitable for laser
engraving in gold. See page 304.

0-8800 M: Metall-Drehkugelschreiber
mit glänzend lackiertem Gehäuse in
schwarz. Clip, Zierringe und Spitze aus
vergoldetem Metall.

Werbeschlüssel

Schaft MS/L,
Oberteil MT/L

0-8800 M: Metal twist ballpoint pen
with glossy lacquered body in black.
Metal clip, metal rings and metal tip
gold-plated.

Advertising code

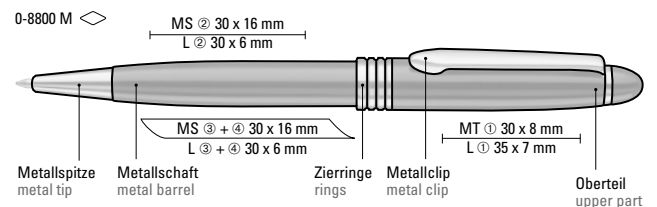
barrel MS/L,
upper part MT/L

0-9900 (● 8-0888)



0-9900 M (● 8-0888)

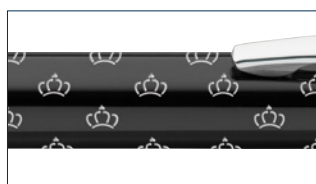
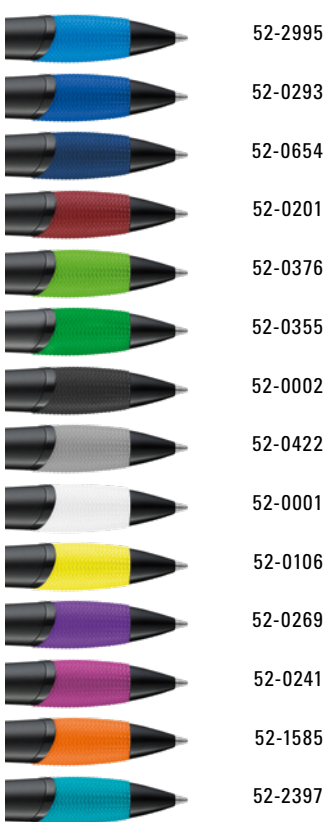

Die Modelle eignen sich für Rundumlasergravur in Hochglanz.
The models are suitable for 360° laser engraving high gloss.

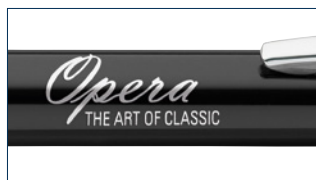

Die Modelle eignen sich für eine Hochglanzlasergravur in silber.
Siehe Seite 305.
The models are suitable for high gloss laser engraving in silver. See page 305.



Etui Empfehlung/ Case suggestion
ETUI 0-0917

Beschreibung auf Seite 288
See description on page 288

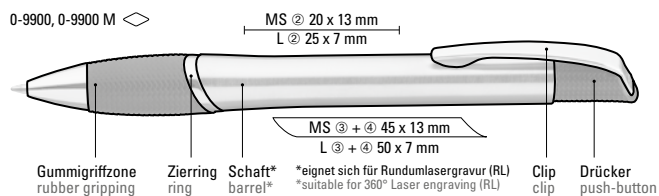

0-9900: Metall-Druckkugelschreiber mit glänzendem Gehäuse, schwarzer Gummigriffzone und glanzverchromten Beschlagteilen.

0-9900 M: Metall-Druckkugelschreiber mit schwarz matt lackiertem Gehäuse, farbige Gummigriffzone und matt schwarzen Beschlagteilen.

0-9900: Metal retractable ballpoint pen with glossy housing, black rubber grip zone and fittings chrome plated.

0-9900 M: Metal retractable ballpoint pen with matt black lacquered housing, coloured rubber grip zone and fittings matt black.

Werbeschlüssel

Schaft MS/L/RL

Advertising code

barrel MS/L/RL

LUNG VEREDELUNG VEREDELUNG
FINISHING FINISHING



ELUNG VEREDELUNG VERED NG FINISHING FINISHING F





VIP
siehe Seite 217
see page 217

STRAIGHT
siehe Seite 239/241
see page 239/241

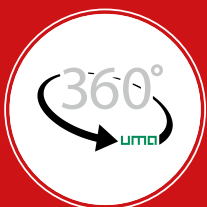

GLÄNZENDE AUSSICHTEN

Elegant, effektiv, edel – mit unseren innovativen Veredelungsverfahren werden aus Metall-Schreibgeräten unvergesslich glanzvolle Werbeträger.



ELEGANCE
siehe Seite 221
see page 221



MOOD
siehe Seite 211
see page 211

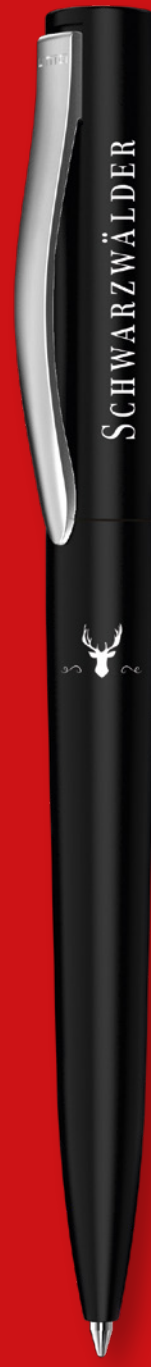

TITAN ONE
siehe Seite 219
see page 219

BRILLIANT PROSPECTS

Elegant, decorative, noble – with our innovative finishing methods, we transform metal writing instruments into unforgettable, glamorous promotional tools.



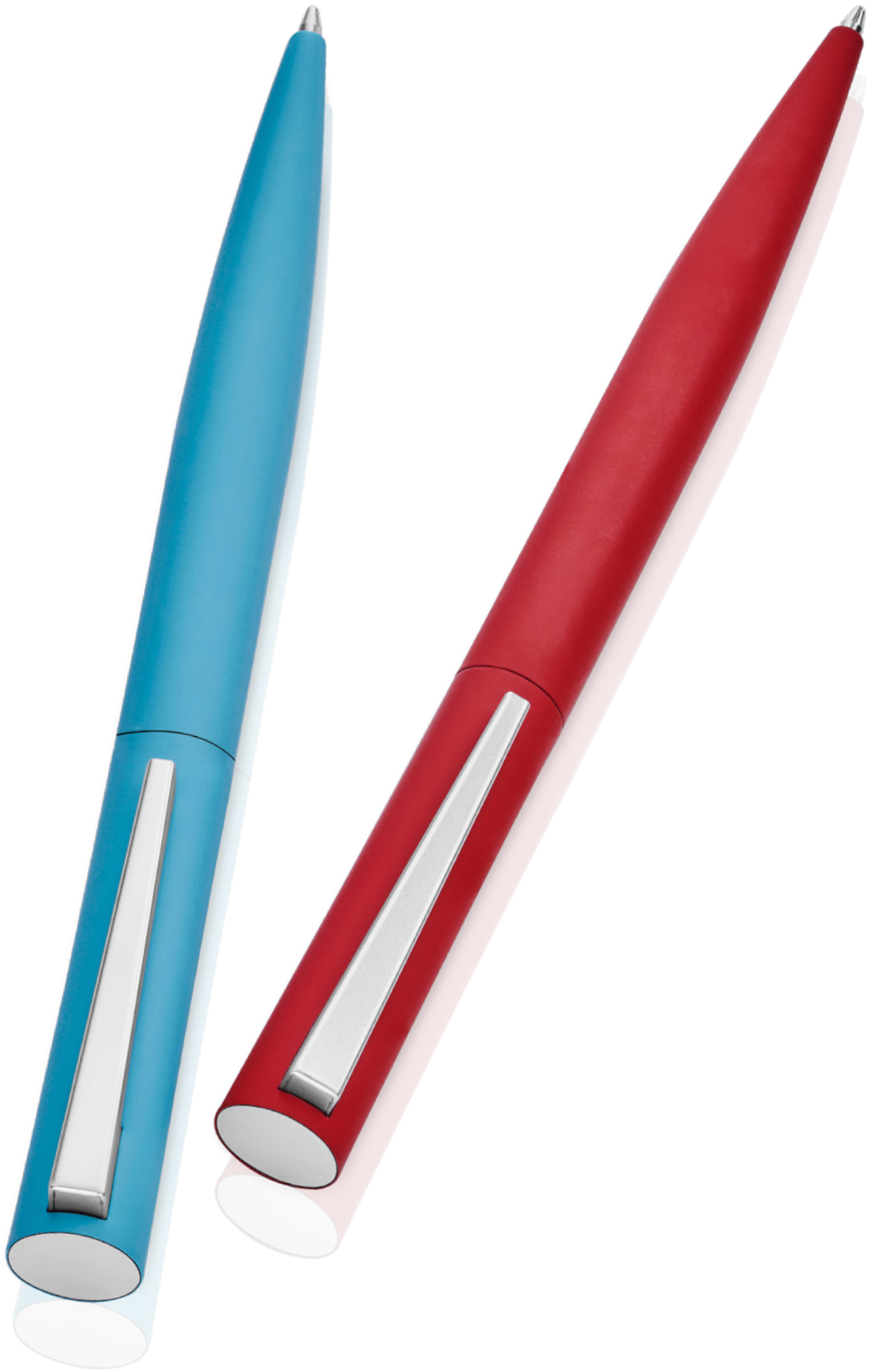

0-9610 GUM (● 8-0844)
0-9612 R GUM (● 8-0806)

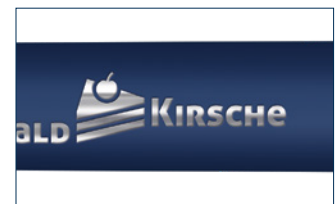
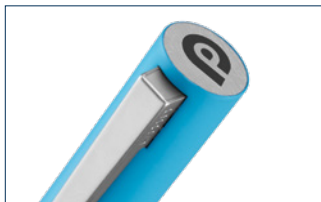

Die Modelle eignen sich für eine Hochglanzlasergravur in silber. Siehe Seite 305.

The models are suitable for high gloss laser engraving in silver. See page 305.

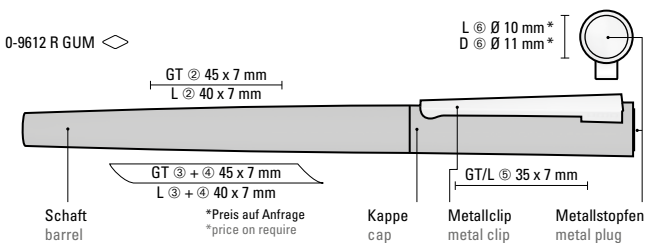
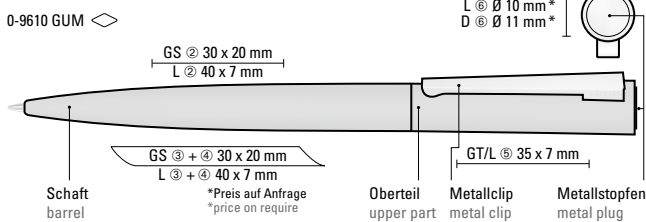

0-9610 GUM: Metall-Drehkugelschreiber mit Softtouch-Gehäuse, gefederter Metallclip und Stopfen matt verchromt.

0-9612 R GUM: Metall-Rollerball mit Softtouch-Gehäuse, gefederter Metallclip und Stopfen matt verchromt.

Werbeschlüssel 0-9610 GUM

Schaft GS/L,
Oberteil GT/L,
Stopfen L*/D*

Werbeschlüssel 0-9612 R GUM

Schaft GT/L,
Kappe GT/L,
Stopfen L*/D*

0-9610 GUM: Metal twist ballpoint pen with softtouch housing, spring-mounted metal clip and plug matt chromed.

0-9612 R GUM: Metal rollerball with softtouch housing, spring-mounted metal clip and plug matt chromed.

Advertising code 0-9610 GUM

barrel GS/L,
upper part GT/L,
plug L*/D*

Advertising code 0-9612 R GUM

barrel GT/L,
cap GT/L,
plug L*/D*



0-9630 F GUM (● 8-0855)
0-9630 GUM (● 8-0855)



Die Modelle eignen sich für eine Hochglanzlasergravur in Silber. Siehe Seite 305.

The models are suitable for high gloss laser engraving in silver. See page 305.

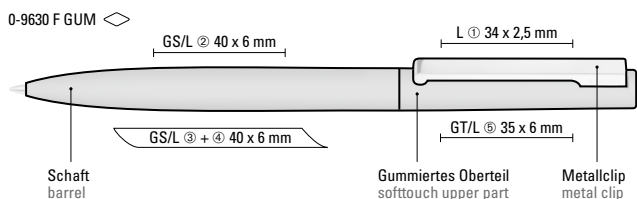

0-9630 F GUM: Metall-Drehkugelschreiber mit Softtouch-Gehäuse und gefederter Metallclip silber glänzend.

0-9630 F GUM: Metal twist ballpoint pen with softtouch barrel and spring-mounted metal clip in glossy silver.

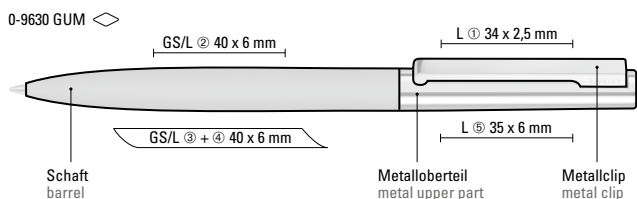

0-9630 GUM: Metall-Drehkugelschreiber mit Softtouch-Schaft, glanzverchromtem Metalloberteil und gefederter Metallclip.

0-9630 GUM: Metal twist ballpoint pen with softtouch barrel, upper part chrome plated and spring-mounted metal clip.

Werbeschlüssel 0-9630 F GUM

Schaft GS/L,
Kappe GT/L, Clip L

barrel GS/L,
cap GT/L, clip L

Werbeschlüssel 0-9630 GUM

Schaft GS/L,
Kappe L, Clip L

barrel GS/L,
cap L, clip L



0-9540 SI (● 8-0855)

66-9441



66-9521



66-9140



66-9361



66-9321



● 8-0855

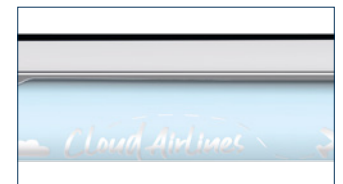

Das Modell eignet sich für eine Hochglanzlasergravur in Silber. Siehe Seite 305.

The model is suitable for high gloss laser engraving in silver. See page 305.

0-9540 SI: Metall-Druckkugelschreiber mit ellipsenförmigem mattem-Gehäuse. Metallclip, Metallspitze und ellipsenförmigem Drücker silber glänzend.

Werbeschlüssel

Schaft MT/L

0-9540 SI: Metal retractable ballpoint pen with elliptical matt housing. Metal clip, metal tip and elliptical push-button chrome plated.

Advertising code

barrel MT/L

0-9540 SI ◊

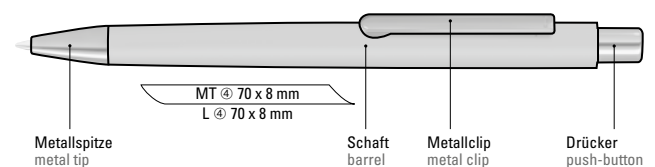

0-9540 GUM (● 8-0855)

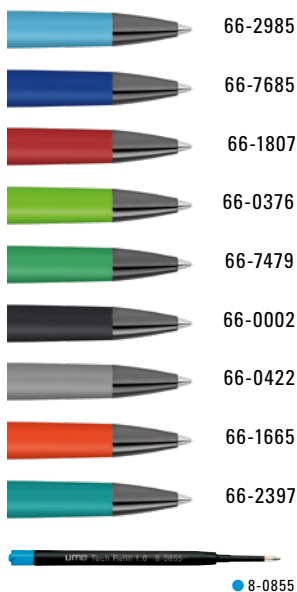

Ellipsenförmiger Schaft
Elliptical barrel



Das Modell eignet sich für eine Hochglanzlasergravur in Silber.
Siehe Seite 305.

The model is suitable for high gloss laser engraving in silver.
See page 305.

0-9540 GUM ◊

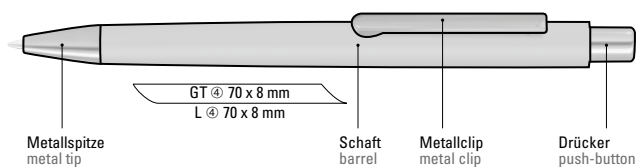

0-9540 GUM: Metall-Druckkugelschreiber mit ellipsenförmigem Softtouch-Gehäuse. Metallclip, Metallspitze und ellipsenförmiger Drücker GUN metallic.

Werbeschlüssel

Schaft GT/L

0-9540 GUM: Metal retractable ballpoint pen with elliptical softtouch housing. Metal clip, metal tip and elliptical push-button GUN metallic.

Advertising code

barrel GT/L

STRAIGHT SI TOUCH
0-9450 SI TO

STRAIGHT SI R TOUCH
0-9452 SI R TO

Farb-Code/Minen
Colour code/Refills



0-9450 SI TO (● 8-0855)

0-9452 SI R TO (● 8-0806)

58-2995



58-0293



58-0654



58-0201



58-0376



58-0355



58-0002



58-0422



58-0001



58-0106



58-0269



58-0241



58-1585



58-2397



58-0004



● 8-0855



● 8-0806

0-9450 SI TO: Metall-Drehkugelschreiber mit mattem Gehäuse. Metallclip und Metallspitze silber glänzend. Gummirtes Schaftende für die Touchscreensteuerung.

0-9452 SI R TO: Metall-Rollerball mit mattem Gehäuse. Metallclip und Zierring silber glänzend, Griffzone schwarz. Gummirtes Schaftende für die Touchscreensteuerung.

Werbeschlüssel 0-9450 SI TO
Schaft MS/L, Clip L,
Oberteil MT/L

Werbeschlüssel 0-9452 SI R TO
Schaft MT/L, Clip L,
Kappe MT/L

0-9450 SI TO: Metal twist ballpoint pen with matt housing. Metal clip and metal tip and push-button chrome plated. Black rubber ball with integrated touch screen control.

0-9452 SI R TO: Metal rollerball with matt housing. Metal clip and ring chrome plated, grip zone black. Black rubber ball with integrated touch screen control.

Advertising code 0-9450 SI TO
barrel MS/L, clip L,
upper part MT/L

Advertising code 0-9452 SI R TO
barrel MT/L, clip L,
cap MT/L

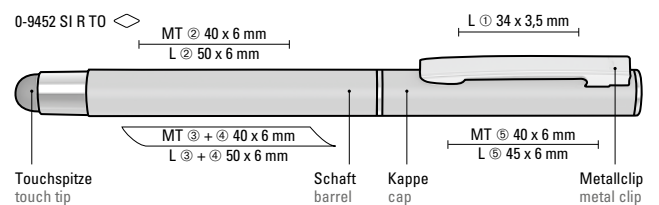
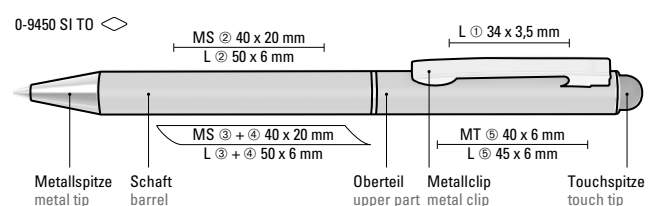

0-9450 SI (● 8-0855)
0-9457 SI B (0,7 mm)

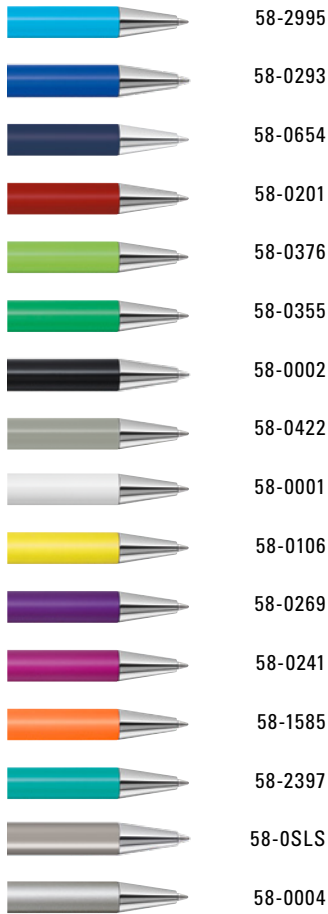

0-9450 SI GUM (● 8-0855)



Die Modelle eignen sich für Rundumlasergravur.

The models are suitable for 360° laser engraving.

Die Modelle eignen sich für eine Hochglanzlasergravur in Silber. Siehe Seite 305.

The models are suitable for high gloss laser engraving in silver. See page 305.

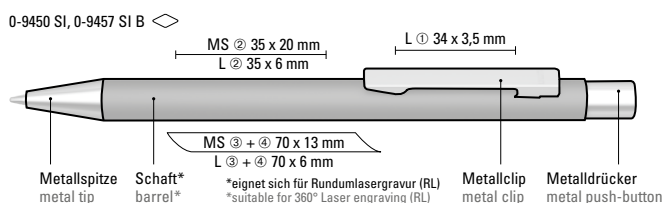
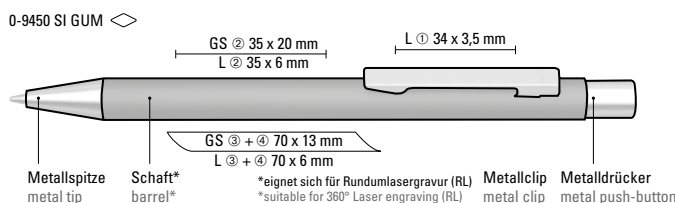

0-9450 SI: Metall-Druckkugelschreiber mit mattem Gehäuse oder lackiertem Edelstahl-Gehäuse. Metallclip, Metallspitze und Drücker Silber glänzend.

0-9457 SI B: Metall-Druckbleistift (0,7mm) mit mattem Gehäuse. Metallclip, Metallspitze und Drücker Silber glänzend. Radiergummi im Drücker.

0-9450 SI GUM: Metall-Druckkugelschreiber mit Softtouch-Gehäuse, Metallclip, Metallspitze und Drücker Silber glänzend.

Werbeschlüssel 0-9450 SI
Schaft MS/L/RL, Clip L
Werbeschlüssel 0-9457 SI B
Schaft MS/L/RL, Clip L
Werbeschlüssel 0-9450 SI GUM
Schaft GS/L/RL, Clip L

0-9450 SI: Metal retractable ballpoint pen with matt housing or lacquered stainless steel housing. Metal clip, metal tip and push-button chrome plated.

0-9457 SI B: Metal retractable pencil (0.7mm) with matt housing. Metal clip, metal tip and push-button chrome plated. Rubber inside the push-button.

0-9450 SI GUM: Metal retractable ballpoint pen with softtouch housing. Metal clip, metal tip and push-button chrome plated.

Advertising code 0-9450 SI
barrel MS/L/RL, clip L
Advertising code 0-9457 SI B
barrel MS/L/RL, clip L
Advertising code 0-9450 SI GUM
barrel GS/L/RL, clip L

STRAIGHT GUM
0-9450 GUM

STRAIGHT GUM B
0-9457 GUM B

STRAIGHT M GUM
0-9450 M GUM

Farb-Code/Minen
Colour code/Refills



0-9450 GUM (● 8-0855)
0-9457 GUM B (0,7mm)

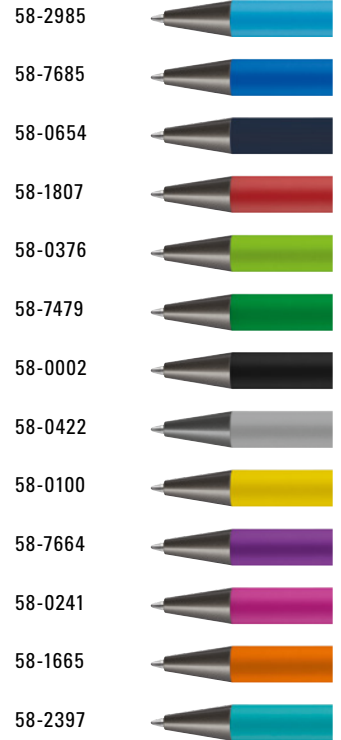

0-9450 M GUM (● 8-0855)



Recycelte Variante
STRAIGHT GUM RECY &
STRAIGHT M GUM RECY
Seite/page 94-95



Die Modelle eignen sich für eine Hochglanzlasergravur in silber. Siehe Seite 305.

The models are suitable for high gloss laser engraving in silver. See page 305.

0-9450 GUM: Metall-Druckkugelschreiber mit Softtouch-Gehäuse. Metallclip, Metallspitze und Drücker GUN metallic.

0-9457 GUM B: Metall-Druckbleistift (0,7mm) mit Softtouch-Gehäuse. Metallclip, Metallspitze und Drücker GUN metallic. Radiergummi im Drücker.

0-9450 M GUM: Metall-Druckkugelschreiber mit Softtouch-Gehäuse. Metallclip, Metallspitze und Drücker schwarz glänzend.

Werbeschlüssel Schaft GS/L/RL, Clip L

0-9450 GUM: Metal retractable ballpoint pen with softtouch housing. Metal clip, metal tip and push-button GUN metallic.

0-9457 GUM B: Metal retractable pencil (0.7mm) with softtouch housing. Metal clip, metal tip and push-button GUN metallic. Rubber inside the push-button.

0-9450 M GUM: Metal retractable ballpoint pen with softtouch housing. Metal clip, metal tip and push-button glossy black.

Advertising code barrel GS/L/RL, clip L

0-9450 GUM, 0-9450 M GUM, 0-9457 GUM B ◊

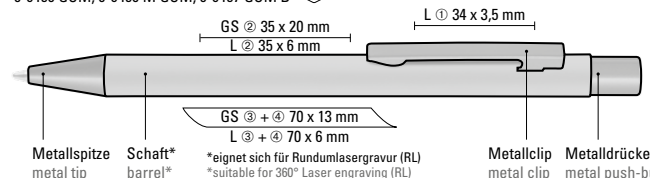

Farb-Code/Minen
Colour code/Refills

STRAIGHT
0-9450

STRAIGHT B
0-9457 B

0-9450 (● 8-0855)
0-9457 B (0,7mm)

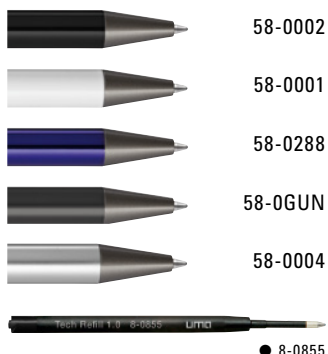

Die Modelle eignen sich für eine Hochglanzlasergravur in Silber. Siehe Seite 305.

The models are suitable for high gloss laser engraving in silver. See page 305.



Die Modelle eignen sich für Rundumlasergravur.

The models are suitable for 360° laser engraving.

0-9450, 0-9457 B ◊

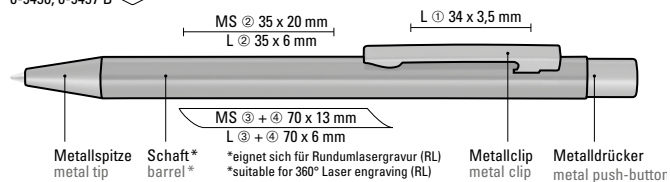

0-9450: Metall-Druckkugelschreiber mit glänzendem Gehäuse. Metallclip, Metallspitze und Drücker GUN metallic.

0-9457 B: Metall-Druckbleistift (0,7mm) mit glänzendem Gehäuse. Metallclip, Metallspitze und Drücker GUN metallic. Radiergummi im Drücker.

Werbeschlüssel Schaft MS/L/RL, Clip L

0-9450: Metal retractable ballpoint pen with glossy housing. Metal clip, metal tip and push-button GUN metallic.

0-9457 B: Metal retractable pencil (0.7mm) with matt housing. Metal clip, metal tip and push-button GUN metallic. Rubber inside the push-button.

Advertising code barrel MS/L/RL, clip L



0-9450 GO (● 8-0855)

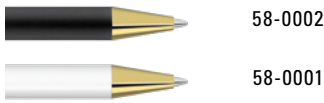

0-9450 RO-GO (● 8-0855)

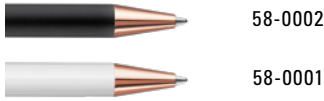

0-9450 RO-GO GUM (● 8-0855)

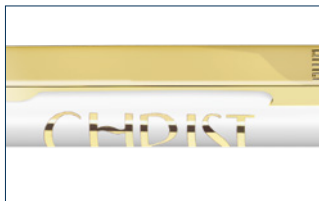

Das Modell 0-9450 GO eignet sich für eine Lasergravur in gold. Siehe Seite 305.

The model 0-9450 GO is suitable for laser engraving in gold. See page 305.



Die Modelle 0-9450 RO GO eignen sich für eine Lasergravur in rotgold. Siehe Seite 305.

The models 0-9450 RO GO are suitable for laser engraving in red gold. See page 305.



Die Modelle eignen sich für Rundumlasergravur.

The models are suitable for 360° laser engraving.

0-9450 GO, 0-9450 RO-GO

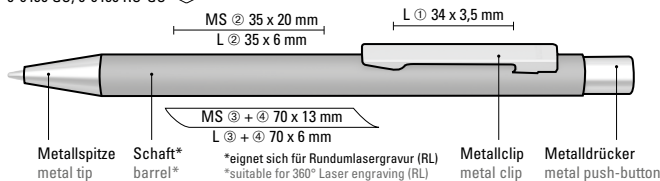

0-9450 RO-GO GUM

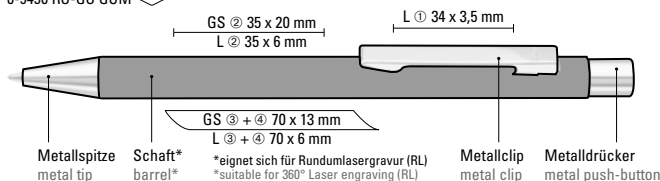

0-9450 GO: Metall-Druckkugelschreiber mit mattem Gehäuse in weiß oder schwarz. Metallclip, Metallspitze und Drücker gold glänzend.

0-9450 RO-GO: Metall-Druckkugelschreiber mit glänzendem Gehäuse in weiß oder mattem Gehäuse in schwarz. Metallclip, Metallspitze und Drücker roségold glänzend.

0-9450 RO-GO GUM: Metall-Druckkugelschreiber mit Softtouch-Gehäuse in schwarz. Metallclip, Metallspitze und Drücker roségold glänzend.

Werbeschlüssel 0-9450 GO
Schaft MS/L/RL, Clip L
Werbeschlüssel 0-9450 RO-GO
Schaft MS/L/RL, Clip L
Werbeschlüssel 0-9450 RO-GO GUM
Schaft GS/L/RL, Clip L

0-9450 GO: Metal retractable ballpoint pen with matt housing in black or white. Metal clip, metal tip and push-button gold plated.

0-9450 RO-GO: Metal retractable ballpoint pen with glossy housing in white or matt black. Metal clip, metal tip and push-button rose gold plated.

0-9450 RO-GO GUM: Metal retractable ballpoint pen with softtouch housing in black. Metal clip, metal tip and push-button rose gold plated.

Advertising code 0-9450 GO
barrel MS/L/RL, clip L
Advertising code 0-9450 RO-GO
barrel MS/L/RL, clip L
Advertising code 0-9450 RO-GO GUM
barrel GS/L/RL, clip L

















Farb-Code/Minen
Colour code/Refills

PYRA
0-9733

PYRA GUM
0-9733 GUM

PYRA M GUM
0-9733 M GUM

- 0-9733** (● 8-0855)
-  66-0004
 -  66-0001
- 0-9733 GUM** (● 8-0855)
-  66-2995
 -  66-0293
 -  66-0201
 -  66-0376
 -  66-0355
 -  66-0002
 -  66-0422
 -  66-0241
 -  66-1585
 -  66-2397
- 0-9733 M GUM** (● 8-0855)
-  66-0002
 -  ● 8-0855



Dreikantiger Softtouch-Schaft
Triangular soft touch barrel



Die Modelle eignen sich für eine Hochglanzlasergravur in Silber.
Siehe Seite 305.
The models are suitable for high gloss laser engraving in silver.
See page 305.

0-9733 ◊

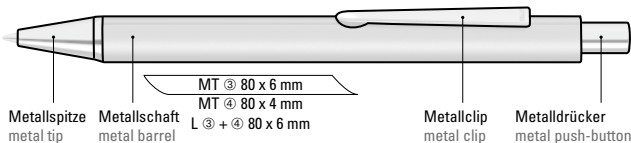

0-9733: Metall-Druckkugelschreiber mit mattem Dreikantgehäuse, Metallclip, Metallspitze und Drücker in Silber glänzend.

0-9733: Metal retractable ballpoint pen with triangular barrel matt finished, metal clip, metal tip and push-button in glossy silver.

0-9733 GUM, 0-9733 M GUM ◊

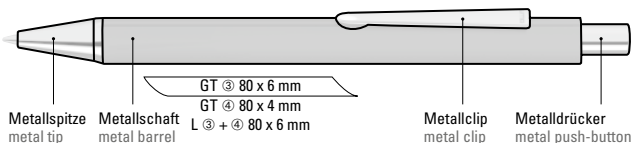

0-9733 GUM: Metall-Druckkugelschreiber mit Softtouch-Dreikantgehäuse, Metallclip, Metallspitze und Drücker in Silber glänzend.

0-9733 GUM: Metal retractable ballpoint pen with softtouch triangular barrel, metal clip, metal tip and push-button in glossy silver.

0-9733 M GUM: Metall-Druckkugelschreiber mit Softtouch-Dreikantgehäuse, Metallclip, Metallspitze und Drücker in Schwarz matt.

0-9733 M GUM: Metal retractable ballpoint pen with softtouch triangular barrel, metal clip, metal tip and push-button in matt black.

Werbeschlüssel 0-9733 Schaft MT/L
Werbeschlüssel 0-9733 GUM Schaft GT/L
Werbeschlüssel 0-9733 M GUM Schaft GT/L

Advertising code 0-9733 barrel MT/L
Advertising code 0-9733 GUM barrel GT/L
Advertising code 0-9733 M GUM barrel GT/L



0-9560 GUM (● 8-0855)
0-9560 M GUM (● 8-0855)



Das Modell 0-9560 GUM eignet sich für eine Hochglanzlasergravur in silber. Siehe Seite 305.

The model 0-9560 GUM is suitable for high gloss laser engraving in silver. See page 305.

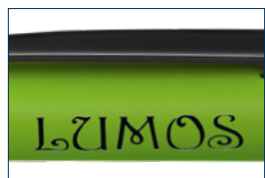

Das Modell 0-9560 M GUM eignet sich für Lasergravur in schwarz. Siehe Seite 305.

The model 0-9560 M GUM is suitable for engraving in black. See page 305.



Recycle Variante
LUMOS RECY
Seite/page 96-97

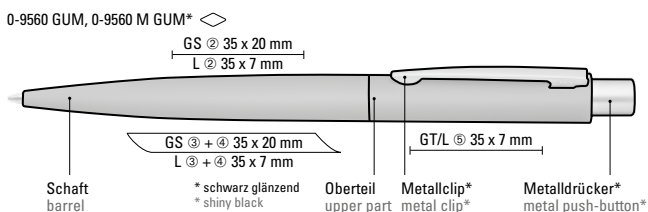

0-9560 GUM: Metall-Druckkugelschreiber mit Softtouch-Gehäuse. Metallclip und Drücker matt verchromt.

0-9560 GUM: Metal retractable ballpoint pen with softtouch housing. Metal clip and push-button matt chromed.

0-9560 M GUM: Metall-Druckkugelschreiber mit Softtouch-Gehäuse. Metallclip und Drücker schwarz glänzend.

0-9560 M GUM: Metal retractable ballpoint pen with softtouch housing. Metal clip and push-button glossy black.

Werbeschlüssel

Schaft GS/L,
Oberteil GT/L

Advertising code

barrel GS/L,
upper part GT/L



0-9560 STONE (● 8-0855)



Das Modell eignet sich für eine Lasergravur in weiß. Siehe Seite 305.

The model is suitable for laser engraving in white. See page 305.

0-9560 STONE ◊

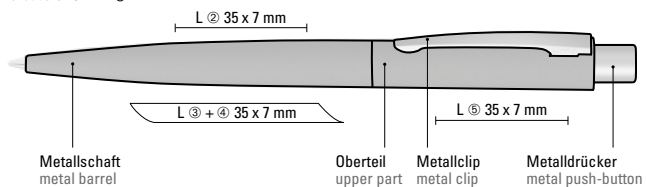

0-9560 STONE: Metall-Druckkugelschreiber mit nachgestellter Beton- bzw. Steinoptik und Haptik. Metallclip und Drücker matt verchromt.

0-9560 STONE: Metal retractable ballpoint pen with reconstructed concrete or stone optics and haptics. Metal clip and push-button matt chromed.

Werbeschlüssel

Schaft L, Oberteil L

Advertising code barrel L, upper part L





Das Modell eignet sich für eine Lasergravur in weiß. Siehe Seite 305.

The model is suitable for laser engraving in white. See page 305.

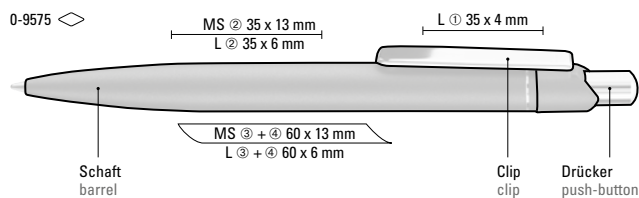

0-9575: Metall-Druckkugelschreiber mit matt lackiertem Aluminiumschaft. Metallclip und Drücker silber glanzverchromt.

Werbeschlüssel

Schaft MS/L, Clip L

0-9575: Metal retractable ballpoint pen with matt lacquered aluminium housing. Metal clip and push-button chrome plated.

Advertising code

barrel MS/L, clip L



0-8330 (● 8-0855)

63-2995

63-0293

63-0201

63-0376

63-0002

63-0422

63-0001

63-0241

63-1585

63-2397

● 8-0855



Das Modell eignet sich für eine
Lasergravur in weiß. Siehe Seite 304.

The model is suitable for laser engraving
in white. See page 304.



Sechskantiges Gehäuse
Hexagonal barrel

0-8330: Metall-Druckkugelschreiber
mit matt lackiertem, sechskantigem
Aluminiumschaft. Metallclip,
Metallspitze und Drücker silber
glänzend. Zierring schwarz glänzend.

Werbeschlüssel Schaft MT/L, Clip L

0-8330: Metal retractable ballpoint pen
with matt lacquered, hexagonal
aluminium barrel. Metal clip, metal tip
and push-button in glossy silver.
Ring in glossy black.

Advertising code barrel MT/L, clip L

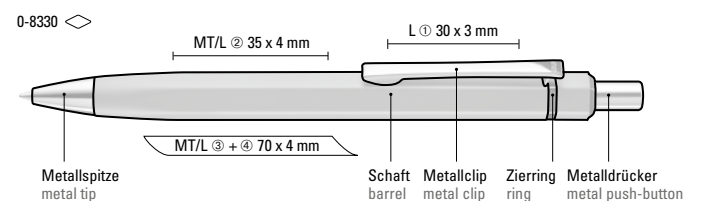



Das Modell eignet sich für eine
Lasergravur in weiß. Siehe Seite 304.

The model is suitable for laser engraving
in white. See page 304.

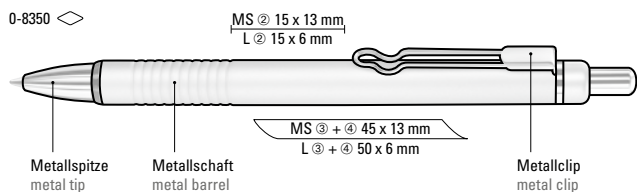

0-8350: Metall-Druckkugelschreiber mit
matt lackiertem Aluminiumschaft und
integrierter Griffzone. Metallbügelclip
und Beschläge glanzverchromt. Zierring
schwarz.

Werbeschlüssel

Schaft MS/L

0-8350: Metal retractable ballpoint pen
with matt lacquered aluminium barrel
and integrated grip zone. Metal clip and
fittings chrome plated. Ring black.

Advertising code

barrel MS/L

VENUS
0-9460

MOON
0-9470

Farb-Code/Minen
Colour code/Refills



0-9460 (● 8-0883)

53-0002



53-2756



53-0179



53-3425



53-0004



● 8-0883

0-9470 (● 8-0883)

53-0002



53-0001



53-2756



53-0179



53-3425



53-0004



● 8-0883



Die Modelle eignen sich für eine Lasergravur in weiß. Siehe Seite 305.

The models are suitable for laser engraving in white. See page 305.

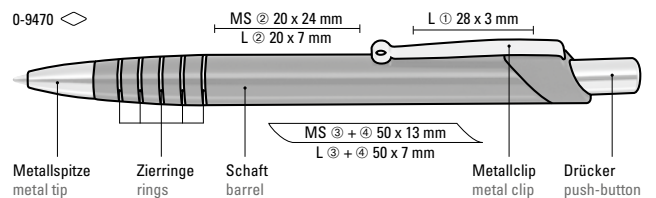
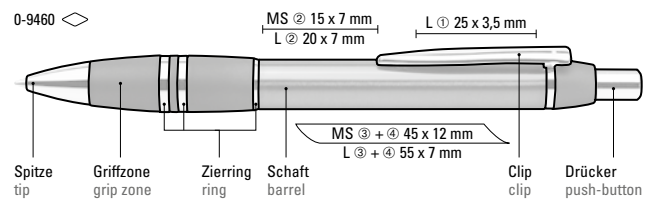

0-9460: Metall-Druckkugelschreiber mit glanzverchromten Beschlügen.

0-9470: Metall-Druckkugelschreiber mit silbernen Zierringen im Gehäuse und elastischem Metallclip. Spitze und Drücker silber glänzend.

Werbeschlüssel Schaft MS/L, Clip L

0-9460: Metal retractable ballpoint pen with glossy chrome fittings.

0-9470: Metal retractable ballpoint pen with silver rings on the barrel, elastic metal clip. Tip and push-button silver glossy.

Advertising code barrel MS/L, clip L

0-9412 (● 8-0883)



0-9480 L (● 8-0883)

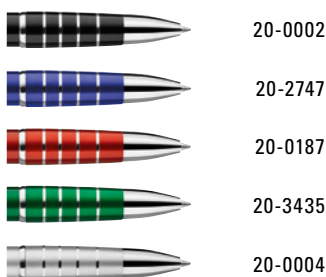

● 8-0883



Die Modelle eignen sich für eine Lasergravur in weiß. Siehe Seite 305.

The models are suitable for laser engraving in white. See page 305.



0-9412 ◊

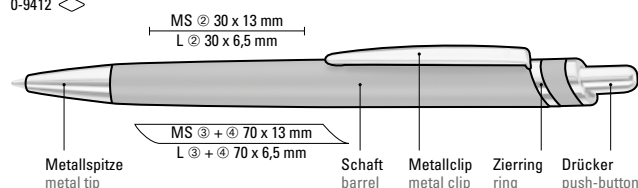

0-9412: Metall-Druckkugelschreiber mit matt lackiertem Aluminiumschaft. Beschlagteile glanzverchromt.

0-9412: Metal retractable ballpoint pen with matt lacquered aluminium housing. Fittings chrome plated.

0-9480 L ◊

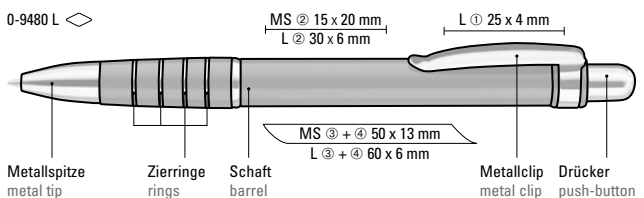

0-9480 L: Metall-Druckkugelschreiber mit lackiertem Aluminiumschaft, Metallclip und Griffzone mit Ringdesign glanzverchromt.

0-9480 L: Metal retractable ballpoint pen with lacquered aluminium housing, metal clip and ring-design grip zone chrome plated.

Werbeschlüssel 0-9412 Schaft MS/L
Werbeschlüssel 0-9480 L Schaft MS/L, Clip L

Advertising code 0-9412 barrel MS/L
Advertising code 0-9480 L barrel MS/L, clip L



0-9440 (● 8-0883)



0-0196 L (●● 8-0866)



Die Modelle eignen sich für eine Lasergravur in grau. Siehe Seite 304.
The models are suitable for laser engraving in grey. See page 304.

0-9440: Metall-Druckkugelschreiber mit Schaft, Drücker, Clip und Spitze glanzverchromt. Gummigriffzone farbig.
0-0196 L: Metall-Druckkugelschreiber mit verchromtem und lackiertem Schaft. Obere Halbkugel und Stopfen farbig transparent. Gelochter Metallclip, Drücker und untere Halbkugel verchromt.

0-9440: Metal retractable ballpoint pen with housing, push-button, clip and tip chrome plated. Coloured rubber grip zone.
0-0196 L: Metal retractable ballpoint pen with chrome and lacquered barrel. Upper hemisphere and plug in transparent colour. Metal clip, push-button and lower hemisphere chrome plated.

Werbeschlüssel 0-9440 Schaft MS/L, Clip L
Werbeschlüssel 0-0196 L Schaft MS/L

Advertising code 0-9440 barrel MS/L, clip L
Advertising code 0-0196 L barrel MS/L

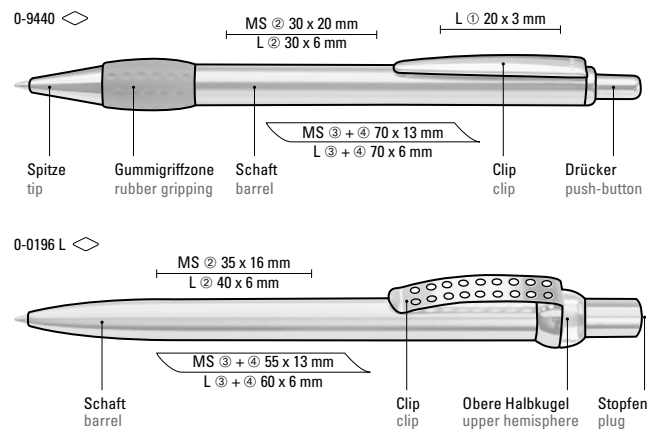

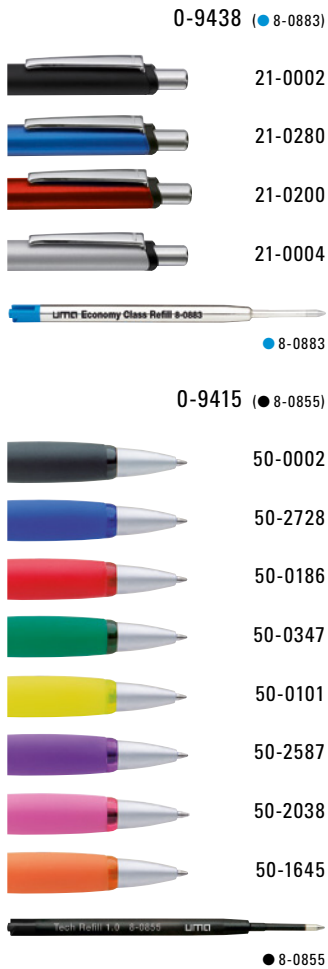

Das Modell 0-9438 eignet sich für eine Lasergravur in weiß. Siehe Seite 304.

The model 0-9438 is suitable for laser engraving in white. See page 304.

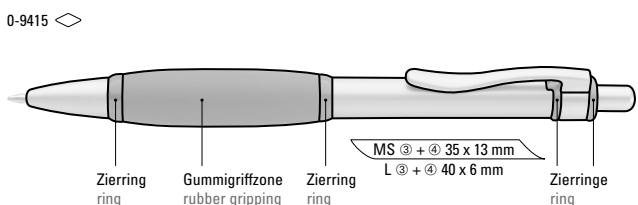
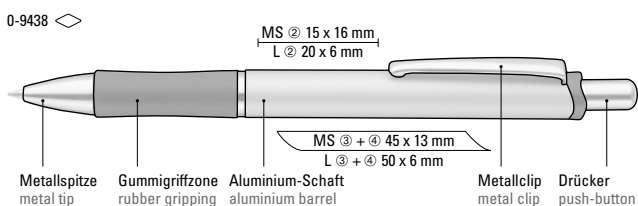

0-9438: Metall-Druckkugelschreiber mit lackiertem Aluminiumschaft. Schwarzer Gummigriffzone und Metallclip.

0-9415: Metall-Druckkugelschreiber mit Schaft, Drücker, Clip und Spitze glanzverchromt. Große, farbige Gummigriffzone.

Werbeschlüssel

Schaft MS/L



Das Modell 0-9415 eignet sich für eine Lasergravur in grau. Siehe Seite 304.

The model 0-9415 is suitable for laser engraving in grey. See page 304.

0-9438: Metal retractable ballpoint pen with lacquered aluminum barrel. Black rubber grip zone and metal clip.

0-9415: Metal retractable ballpoint pen with barrel, push-button, clip and tip chrome plated. Large coloured rubber grip zone.

Advertising code

barrel MS/L



0-8240 (● 8-0855)

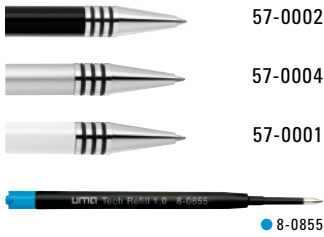

0-8242 R (● 8-0806)

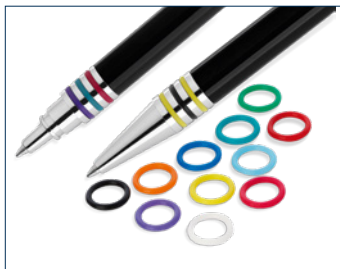
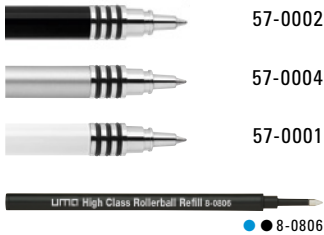

Bereits ab 300 Stück können die Ringe farblich kombiniert werden.

You may choose any colour combination for the three rings for orders over 300 units.



Die Modelle eignen sich für eine Lasergravur in weiß. Siehe Seite 304.

The models are suitable for laser engraving in white. See page 304.



0-8240 ◀

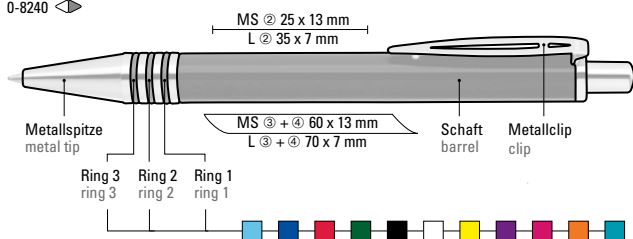

0-8242 R ◀

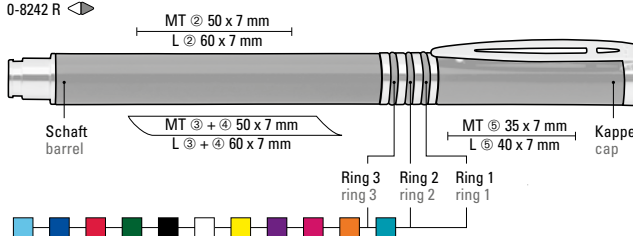

0-8240: Metall-Druckkugelschreiber mit glänzend lackiertem Aluminiumschaft und 3 eingelassenen, kombinierbaren Gummiringen. Metallbeschlagteile glanzverchromt.

0-8242 R: Metall-Rollerball mit glänzend lackiertem Aluminiumschaft und 3 eingelassenen, kombinierbaren Gummiringen. Metallbeschlagteile glanzverchromt.

Werbeschlüssel 0-8240 Schaft MS/L
Werbeschlüssel 0-8242 R Schaft MT/L, Kappe MT/L

0-8240: Metal retractable ballpoint pen with glossy lacquered aluminum housing and 3 recessed combinable rubber rings in the barrel. Metal fittings chrome plated.

0-8242 R: Metal rollerball with glossy lacquered aluminum housing and 3 recessed combinable rubber rings in the barrel. Metal fittings chrome plated.

Advertising code 0-8240 barrel MS/L
Advertising code 0-8242 R barrel MT/L, cap MT/L



Farb-Code/Minen
Colour code/Refills

SLIMLINE
0-8250

SLIMLINE DOM
0-8250 DOM

0-8250 (● 8-0883)
0-8250 DOM (● 8-0883)

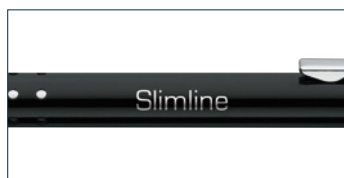

Die Modelle eignen sich für eine Hochglanzlasergravur. Siehe Seite 304.

The models are suitable for high gloss laser engraving. See page 304.

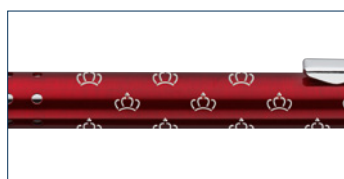

Die Modelle eignen sich für Rundumlasergravur.
The models are suitable for 360° laser engraving.



Doming Stopfen
Doming plug  Ø 7 mm

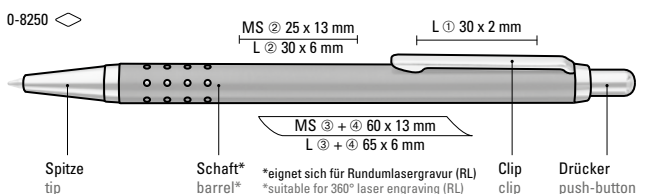

0-8250: Metall-Druckkugelschreiber lackiert mit gelochter Griffzone. Metallbeschlagteile glanzverchromt.

0-8250: Slim metal retractable ballpoint pen with lacquered housing and perforated grip zone. Metal fittings chrome plated.

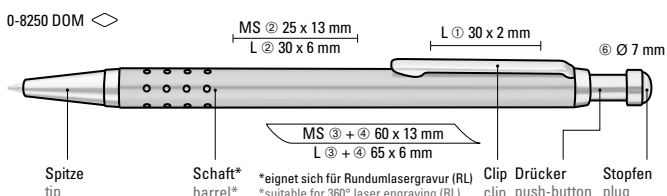

0-8250 DOM: Metall-Druckkugelschreiber lackiert mit gelochter Griffzone. Metallbeschlagteile glanzverchromt. Drücker mit individuell gestaltetem Doming.

0-8250 DOM: Slim metal retractable ballpoint pen with lacquered housing and perforated grip zone. Metal fittings chrome plated and individual designable doming.

Werbeschlüssel 0-8250 Schaft MS/L/RL, Clip L
Werbeschlüssel 0-8250 DOM Schaft MS/L/RL, Clip L, Stopfen D

Advertising code 0-8250 barrel MS/L/RL, clip L
Advertising code 0-8250 DOM barrel MS/L/RL, clip L, plug D



0-8320 (● 8-0855)



63-0002



● 8-0855

0-8322 R (● 8-0806)



63-0002



● 8-0806



Die Modelle eignen sich für eine Lasergravur in weiß. Siehe Seite 304.

The models are suitable for laser engraving in white. See page 304.

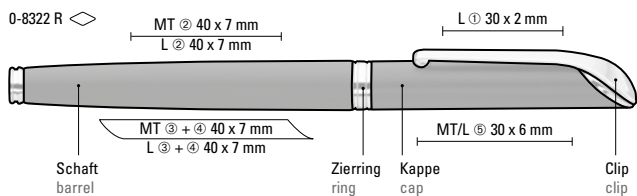
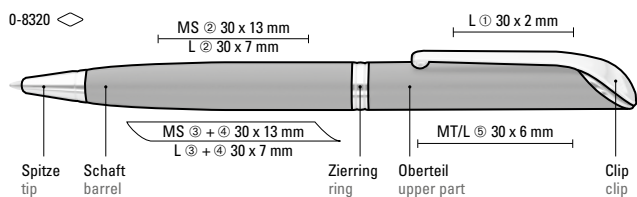

0-8320: Metall-Drehkugelschreiber mit matter Oberfläche. Metallbeschlagteile glanzverchromt.

0-8322 R: Metall-Rollerball mit matter Oberfläche. Metallbeschlagteile glanzverchromt.

Werbeschlüssel 0-8320 Schaft MS/L, Clip L, Oberteil MT/L

Werbeschlüssel 0-8322 R Schaft MT/L, Clip L, Kappe MT/L

0-8320: Metal twist ballpoint pen with matt housing. Metal fittings chrome plated.

0-8322 R: Metal rollerball with matt housing. Metal fittings chrome plated.

Advertising code 0-8320 barrel MS/L, clip L, upper part MT/L

Advertising code 0-8322 R barrel MT/L, clip L, cap MT/L



0-8340 (● 8-0883)
0-8342 R (● 8-0806)

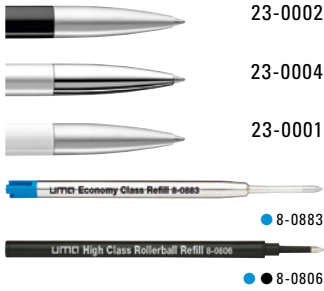

0-8340 TO (● 8-0883)



Die Modelle eignen sich für eine Lasergravur in weiß. Siehe Seite 304.

The models are suitable for laser engraving in white. See page 304.

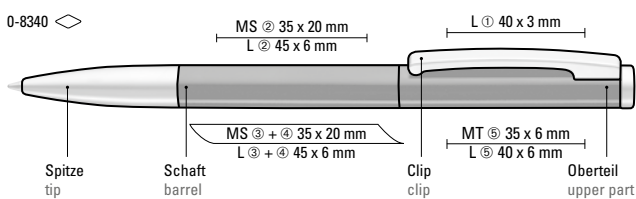

0-8340: Metall-Drehkugelschreiber mit gefedertem Clip. Oberfläche in silber matt mit glänzenden Beschlagteilen oder schwarz bzw. weiß glänzend mit matten Beschlägen.

0-8340: Metal twist ballpoint pen with spring-mounted clip. Surface in matt silver and glossy chrome fittings, glossy black or white with matt fittings.

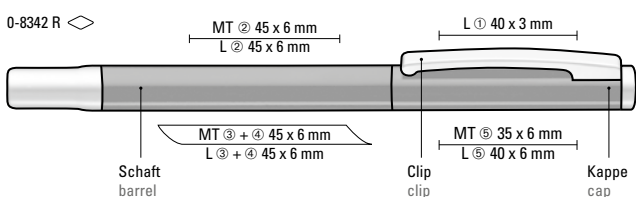

0-8342 R: Metall-Rollerball mit gefedertem Clip. Oberfläche in silber matt mit glänzenden Beschlagteilen oder schwarz bzw. weiß glänzend mit matten Beschlägen.

0-8342 R: Metal rollerball with spring-mounted clip. Surface in matt silver and glossy chrome fittings, matt black or glossy white with matt fittings.

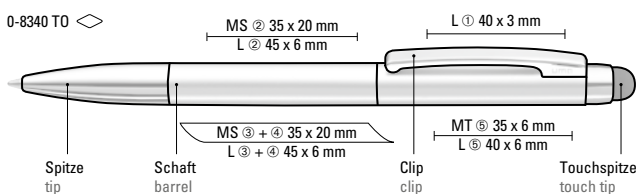

0-8340 TO: Metall-Drehkugelschreiber mit gefedertem Clip. Oberfläche in silber matt mit glänzenden Beschlagteilen. Touchfunktion im Oberteil.

0-8340 TO: Metal twist ballpoint pen with spring-mounted clip. Surface in matt silver, glossy chrome fittings. Black rubber ball with integrated touch screen control.

Werbeschlüssel 0-8340 Schaft MS/L, Clip L, Oberteil MT/L

Advertising code 0-8340 barrel MS/L, clip L, upper part MT/L

Werbeschlüssel 0-8340 TO Schaft MS/L, Clip L, Oberteil MT/L

Advertising code 0-8340 TO barrel MS/L, clip L, upper part MT/L

Werbeschlüssel 0-8342 R Schaft MT/L, Clip L, Kappe MT/L

Advertising code 0-8342 R barrel MT/L, clip L, cap MT/L



0-2622 (● 8-0894)

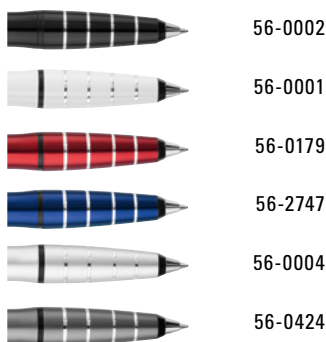

Erhältlich für 0-2622 SET
Available for 0-2622 SET

0-2622 SET (● 8-0894)



Ab 500 Stück kann die Textmarker-Schreibfarbe der Ersatzpatrone im 2in1 SET in den Standardfarben blau, orange, magenta oder grün gegen Aufpreis gewählt werden.

For orders over 500 units, the colour of the replacement refill for the highlighter of the 2in1 SET can be selected for an additional charge among the standard colours blue, orange, magenta or green.

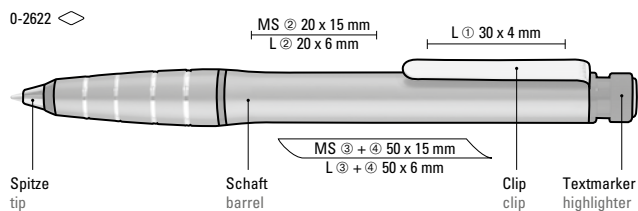

0-2622: Metall-Drehkugelschreiber aus Aluminium mit integriertem gelb schreibenden Textmarker im Schaft. Der Textmarker lässt sich mittels Drehbewegung aus dem Schaft herausnehmen und kann separat genutzt werden.

0-2622: Metal twist ballpoint pen with aluminium housing and integrated yellow writing text marker in the barrel. The highlighter can be twisted out of the barrel and used separately.

0-2622 SET: 2in1-Set - bestehend aus 2in1 Metall-Drehkugelschreiber aus Aluminium mit integriertem gelb schreibenden Textmarker im Schaft, einer Ersatztextmarkerpatrone und einer D1 Mine schwarz-schreibend – im praktischen Etui mit transparentem Kunststoffschuber inkl. Gebrauchsanweisung.

0-2622 SET: 2in1 set - It consists of a 2in1 twist ballpoint pen with aluminium housing and integrated yellow highlighter in the barrel, a replacement highlighter refill and a black D1 refill – in a practical case with transparent plastic slipcase incl. instructions for use.

Werbeschlüssel Schaft MS/L, Clip L

Advertising code barrel MS/L, clip L



Das Modell eignet sich für eine Lasergravur in weiß. Siehe Seite 304.
The model is suitable for laser engraving in white. See page 304.



2in1-Besonderheiten:

- zwei Schreibgeräte in einem
- Drehkugelschreiber mit integriertem Textmarker
- Aluminium-Gehäuse mit edler metallic-Lackierung
- stilvolle Griffzone für besten Schreibkomfort
- Trend-Design in sechs Farben
- Tampondruck oder Lasergravur-Veredelung

2in1 special features:

- two writing devices in one
- twist ballpoint pen with integrated text marker
- aluminium housing with noble metallic finish
- stylish grip zone for superb writing comfort
- trend design in six colours
- pad printing or laser engraving finishing





Die Modelle eignen sich für eine Lasergravur in weiß. Siehe Seite 305.

The models are suitable for engraving in white. See page 305.

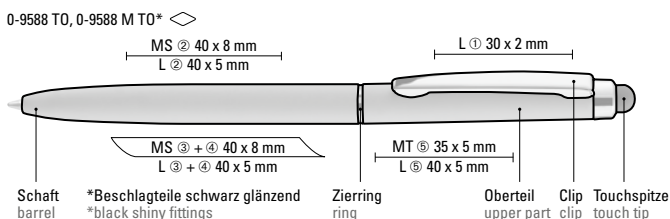

0-9588 TO: Metall-Drehkugelschreiber mit farbig mattem oder weiß glänzendem Gehäuse und silber glänzenden Beschlagteilen. Gummirtes Schaftende für die Touchscreensteuerung.

0-9588 M TO: Metall-Drehkugelschreiber mit schwarz mattem Gehäuse und schwarz glänzenden Beschlagteilen. Gummirtes Schaftende für die Touchscreensteuerung.

0-9588 TO: Metal twist ballpoint pen with matt coloured or glossy white housing and silver glossy fittings. Black rubber ball with integrated touch screen control.

0-9588 M TO: Metal twist ballpoint pen with matt black housing and glossy black fittings. Black rubber ball with integrated touch screen control.

Werbeschlüssel Schaft MS/L, Clip L, Oberteil MT/L

Advertising code barrel MS/L, clip L, upper part MT/L



HIGHLIGHTER
HTER



ER **HIGHLIGHTER** HIGHLIGHTER
LIGHTER HIGHLIGHTER HIGHLIGHTER



uma LIQEO - die Highlighter-Neuheit!

Neues Flüssigtintenleitsystem - Bessere Schreibqualität - Höhere Leuchtkraft -
Längere Schreibdauer - Umweltfreundlicher - Produziert nach EN-71, ASTM D-4236

uma LIQEO - the highlighter novelty!

New liquid ink delivery system - Better writing quality - Greater luminance -
Longer writing time - Ecologically superior - Produced in acc. with EN-71, ASTM D-4236



0-0240
50-0801
50-0802
50-0930
50-0814
50-0806
50-0804



Kombinieren Sie Ihr Set mit
Ihren Highlighter-Wunschfarben.
Configure your set with your
highlighter colours.



0-0240/4 ◊

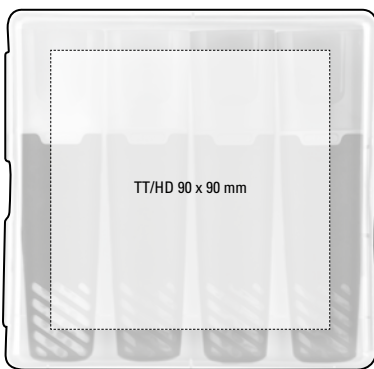

0-0240/2 P ◊

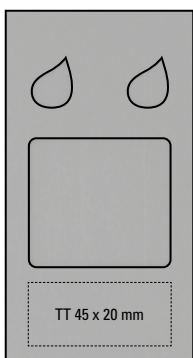

0-0240/3 P ◊

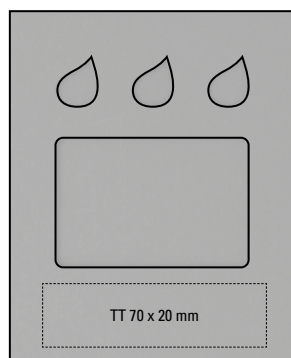

0-0240: Flüssig-Textmarker mit schwarzem Schaft und transparenter Kappe in Schreibfarbe. Ohne Pumpen oder Anstechen sofort einsatzfähig, umweltfreundlicher, längere Schreibdauer und höhere Leuchtkraft als herkömmliche Textmarker.

0-0240/4: Flüssig-Textmarkerset bestehend aus 4 LIQEO HIGHLIGHTER in einer klar transparenten Kunststoffverpackung. Standardfarben der Textmarker in gelb, grün, magenta und blau. Optional wählbare Textmarkerfarben: orange und violett.

0-0240/2 P: Pappfaltschachtel aus schwarzer Kartonage für 2er Set-Lösung uma LIQEO HIGHLIGHTER 0-0240.

0-0240/3 P: Pappfaltschachtel aus schwarzer Kartonage für 3er Set-Lösung uma LIQEO HIGHLIGHTER 0-0240.

Werbeschlüssel 0-0240 Schaft P, Kappe P

Werbeschlüssel 0-0240/4 Highlighter P, Etuis TT/HD

Werbeschlüssel 0-0240/2 P Etui TT

Werbeschlüssel 0-0240/3 P Etui TT

0-0240: Liquid highlighter with black barrel and transparent cap in writing colour. Writes longer and more intensive as conventional highlighter, is without pumping or tapping operational immediately, supported in this way the sustainability concept.

0-0240/4: Liquid highlighter set consisting of 4 LIQEO HIGHLIGHTERS in clear transparent plastic packaging. Standard colours for highlighters are yellow, green, pink and blue. Optional colours orange and purple can be chosen.

0-0240/2 P: Cardboard case in black for 2 uma LIQEO HIGHLIGHTER 0-0240.

0-0240/3 P: Cardboard case in black for 3 uma LIQEO HIGHLIGHTER 0-0240.

Advertising code 0-0240 barrel P, cap P

Advertising code 0-0240/4 highlighter P, cases TT/HD

Advertising code 0-0240/2 P cases TT

Advertising code 0-0240/3 P cases TT

LIQEO HIGHLIGHTER MINI
0-0250LIQEO HIGHLIGHTER MINI 4er SET
0-0250/4Farb-Code/Minen
Colour code/Refills

0-0250

50-0801

50-0802

50-0930

50-0814

50-0806

50-0804



Kombinieren Sie Ihr Set mit
Ihren Highlighter-Wunschfarben.
Configure your set with your
highlighter colours.

uma LIQEO - die Highlighter-Neuheit!

Neues Flüssigtintenleitsystem - Bessere Schreibqualität -

Höhere Leuchtkraft - Längere Schreibdauer -

Umweltfreundlicher - Produziert nach EN-71, ASTM D-4236

uma LIQEO - the highlighter novelty!

New liquid ink delivery system - Better writing quality -

Greater luminance - Longer writing time - Ecologically

superior - Produced in acc. with EN-71, ASTM D-4236



0-0250: Flüssig-Textmarker MINI mit schwarzem Schaft und transparenter Kappe in Schreibfarbe. Ohne Pumpen oder Anstechen sofort einsatzfähig, umweltfreundlicher, längere Schreibdauer und höhere Leuchtkraft als herkömmliche Textmarker.

0-0250/4: Flüssig-Textmarkerset bestehend aus 4 LIQEO HIGHLIGHTER MINI in einer klar transparenten Kunststoffverpackung. Standardfarben der Textmarker in gelb, grün, magenta und blau. Optional wählbare Textmarkerfarben: orange und violett.

Werbeschlüssel 0-0250 Schaft P,
Kappe P

Werbeschlüssel 0-0250/4 Highlighter P,
Etuis TT/HD

0-0250: Liquid highlighter MINI with black barrel and transparent cap in writing colour. Writes longer and more intensive as conventional highlighter, is without pumping or tapping operational immediately, supported in this way the sustainability concept.

0-0250/4: Liquid highlighter set consisting of 4 LIQEO HIGHLIGHTERS MINI in clear transparent plastic packaging. Standard colours for highlighters are yellow, green, pink and blue. Optional colours orange and purple can be chosen.

Advertising code 0-0250 barrel P, cap P

Advertising code 0-0250/4 highlighter P,
cases TT/HD

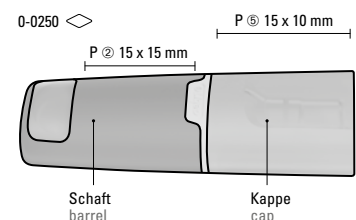

0-0250/4 ⊕

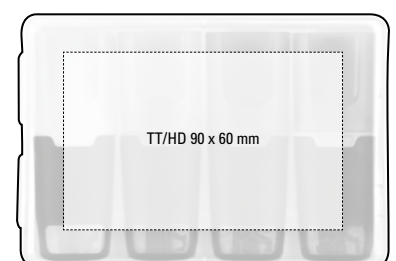

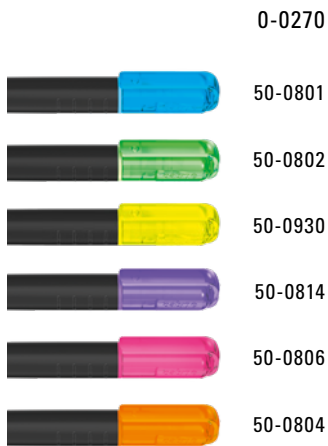

Kombinieren Sie Ihr Set mit Ihren Highlighter-Wunschfarben.
Configure your set with your highlighter colours.

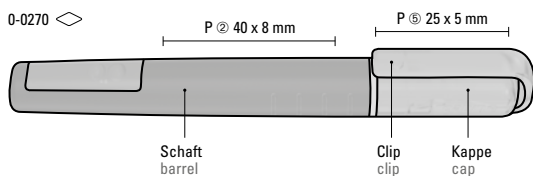

0-0270/4 ◊

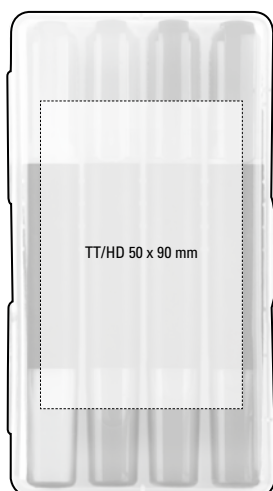

0-0270: Flüssig-Textmarker in Stiftform mit schwarzem Schaft und transparenter Kappe in Schreibfarbe. Ohne Pumpen oder Anstechen sofort einsatzfähig, umweltfreundlicher, längere Schreibdauer und höhere Leuchtkraft als herkömmliche Textmarker.

0-0270/4: Flüssig-Textmarkerset bestehend aus 4 LIQEO HIGHLIGHTER PEN in einer klar transparenten Kunststoffverpackung. Standardfarben der Textmarker in gelb, grün, magenta und blau. Optional wählbare Textmarkerfarben: orange und violett.

Werbeschlüssel 0-0270 Schaft P, Kappe P

Werbeschlüssel 0-0270/4 Highlighter P, Etuis TT/HD

0-0270: Liquid highlighter pen-shaped with black barrel and transparent cap in writing colour. Writes longer and more intensive as conventional highlighter, is without pumping or tapping operational immediately, supported in this way the sustainability concept.

0-0270/4: Liquid highlighter set consisting of 4 LIQEO HIGHLIGHTERS PEN in clear transparent plastic packaging. Standard colours for highlighters are yellow, green, pink and blue. Optional colours orange and purple can be chosen.

Advertising code 0-0270 barrel P, cap P

Advertising code 0-0270/4 highlighter P, cases TT/HD



TEXTMARKER
HIGHLIGHTER
0-0200



TEXTMARKER 2ER SET
HIGHLIGHTER SET OF 2
0-0200/2



BESCHREIBUNG
DESCRIPTION

0-0200: Textmarker mit Kunststoffgehäuse, Kappe und Clip in weiß. Mundstück mit Zierring und Stopfen in der Schreibfarbe. Standardfarben gelb, grün, magenta.

Werbeschlüssel

Schaft P, Clip P

0-0200: Highlighter with plastic housing, cap and clip in white. Section with ring and plug in writing colour. Standard colours are yellow, green, magenta.

Advertising code

barrel P, clip P

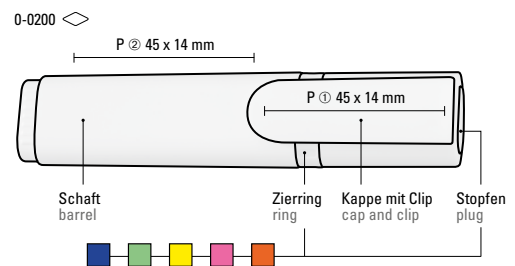

BESCHREIBUNG
DESCRIPTION

0-0200/2: Textmarker 2er-Set aus den Standardfarben in transparentem Stecketui.

Werbeschlüssel

Schaft P, Clip P

0-0200/2: Highlighter set of 2 from the standard colours in transparent slip in case.

Advertising code

barrel P, clip P

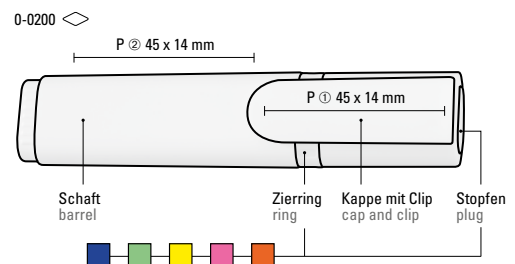

TEXTMARKER SET
HIGHLIGHTER SET
0-0200/3



Modell auf Anfrage auch mit blauem oder orangenem Textmarker.

On request the item is available with blue and orange highlighter.



BESCHREIBUNG
DESCRIPTION

0-0200/3: Set-Box in Köcherform mit 3 Textmarkern (0-0200) in verschiedenen Schreibfarben (gelb/grün/magenta). Auch mit Klebebänderole erhältlich – Preis auf Anfrage.

Werbeschlüssel

Schaft P, Clip P, Box TT

0-0200/3: Set box in quiver form with 3 highlighters (0-0200) in different writing colours (yellow/green/magenta). Also available with adhesive sleeve – price on request.

Advertising code

barrel P, clip P, box TT

Farb-Code (Schreibfarben)
Colour code (Ink colours)

0-0200

50-0225

50-7481

50-0809

50-1575

50-2915



0-0200/3 ◊

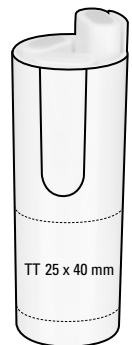

TEXTMARKER SET SI
HIGHLIGHTER SET SI
0-0200/3 SI



Modell auf Anfrage auch mit blauem oder orangenem Textmarker.

On request the item is available with blue and orange highlighter.



BESCHREIBUNG
DESCRIPTION

0-0200/3 SI: Silberne Set-Box in Köcherform mit 3 Textmarkern (0-0200) in verschiedenen Schreibfarben (gelb/grün/magenta). Auch mit Klebebänderole erhältlich – Preis auf Anfrage.

Werbeschlüssel

Schaft P, Clip P, Box TT

0-0200/3 SI: Silver set box in quiver form with 3 highlighters (0-0200) in different writing colours (yellow/green/magenta). Also available with adhesive sleeve – price on request.

Advertising code

barrel P, clip P, box TT

Farb-Code (Schreibfarben)
Colour code (Ink colours)

0-0200

50-0225

50-7481

50-0809

50-1575

50-2915



0-0200/3 SI ◊

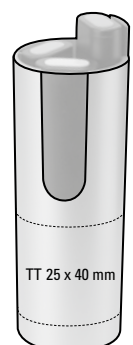



ZUBEHÖR
ACCESSORIES

ZUBEHÖR
ACCESSORIES



OR ZUBEHÖR ZUBEHÖR ZUBEHÖR ZUBEHÖR
OIRES ACCESSOIRES ACCESSOIRES ACCESSOIRES



SET BOX
0-0945/3

SET BOX
0-0945/4

BESCHREIBUNG
DESCRIPTION

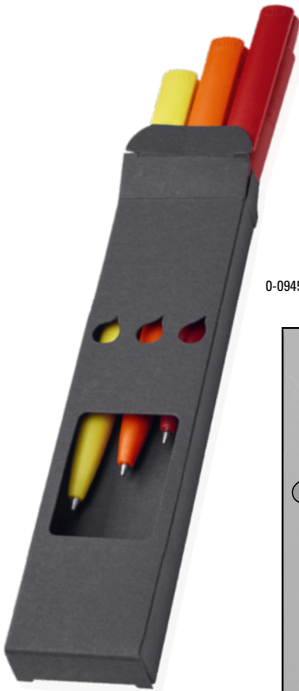

0-0945/3 ◊

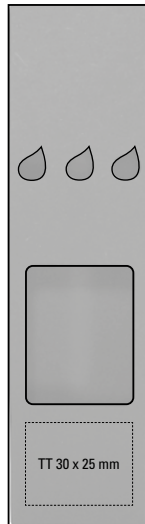

0-0945/4 ◊

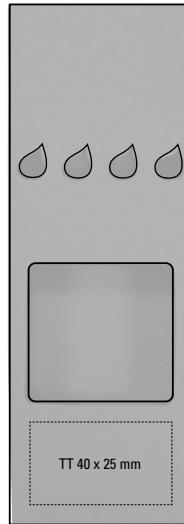

0-0945/3: Pappfaltschachtel aus schwarzer Kartonage für 3er Set-Lösung.

0-0945/4: Pappfaltschachtel aus schwarzer Kartonage für 4er Set-Lösung.

Werbeschlüssel TT

0-0945/3: Cardboard case in black for set of three pens.

0-0945/4: Cardboard case in black for set of four pens.

Advertising code TT

SQUARE
0-0943

BESCHREIBUNG
DESCRIPTION

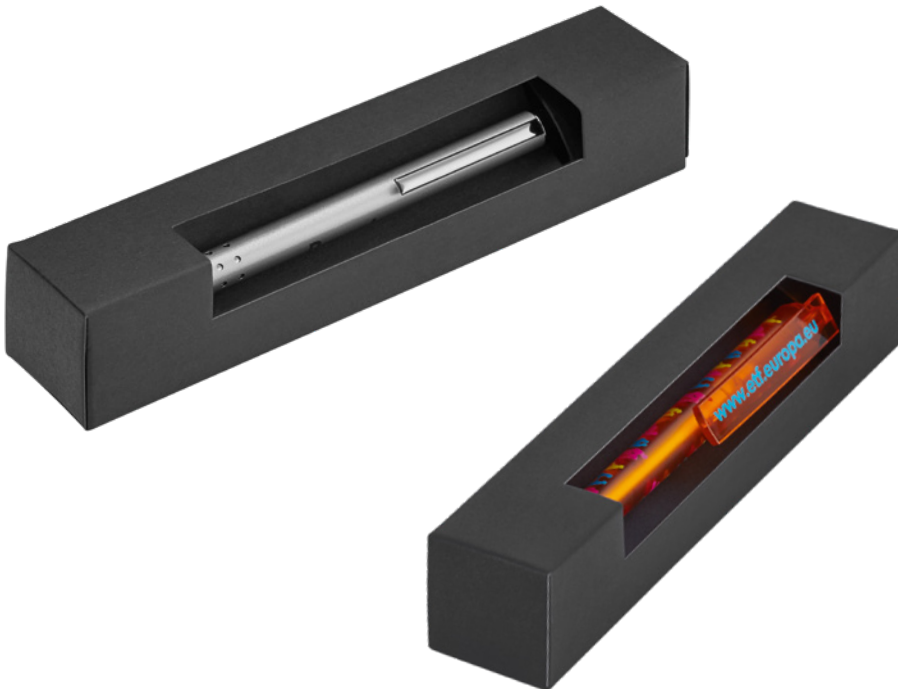

0-0943: Pappstecketui in schwarz mit offenem Sichtfenster auf das Schreibgerät.

Werbeschlüssel TT

0-0943: Cardboard case in black with open window to see the writing instrument.

Advertising code TT

0-0943 ◊



TT
25 x 25
mm

DREIECKSVERPACKUNG
TRIANGULAR ETUI
0-0933 CI **new!**



BESCHREIBUNG
DESCRIPTION

0-0933 CI: Dreikant Pappstecketui für ein Schreibgerät mit individuellem CI-Aufdruck.

Werbeschlüssel individuell

0-0933 CI: Triangular cardboard slip-in case for one writing implement with individual CI print.

Advertising code individual



281

ETUIS

KISSENVERPACKUNG
PILLOW PACK
0-0946 CI



BESCHREIBUNG
DESCRIPTION

0-0946 CI: Kissen-schachtel aus Karton für 1-4 Schreibgeräte mit individuellem CI-Aufdruck.

Werbeschlüssel individuell

0-0946 CI: Cardboard case for 1-4 writing instruments with individual CI imprint.

Advertising code individual

DESK KE
0-0506 KE

DESK LUX KE
0-0506 LUX-KE

BESCHREIBUNG
DESCRIPTION



0-0506 KE: Kugelschreiberständer in gedeckten Farben mit passendem Kugelschreiber Modell TURBO an Metallkette (50cm). Geliefert in praktischer Präsentverpackung.

0-0506 LUX-KE: Kugelschreiberständer in silber mit passendem Kugelschreiber Modell TURBO an Metallkette (50cm). Geliefert in praktischer Präsentverpackung.

Werbeschlüssel TT, HD auf Werbepalette

0-0506 KE: Ballpoint pen rack in opaque colours with suitable ballpen TURBO with metal chain (50cm). Supplied in a convenient present box.

0-0506 LUX-KE: Ballpoint pen rack in silver with suitable ballpen TURBO with metal chain (50cm). Supplied in a convenient present box.

Advertising code TT, HD on panel

0-0506 KE, 0-0506 LUX KE ◊

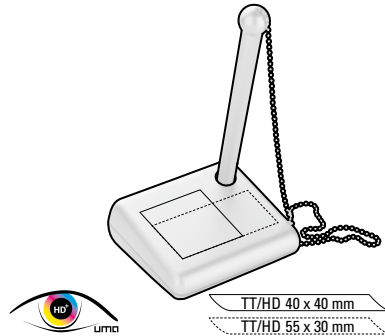

Farb-Code (Minen)
Colour code (Refills)

0-0506 KE
0-0506 LUX-KE

- 50-0002
- 50-0001
- 50-0004



● 8-0855

QUATER
0-0901

TUBE
0-0909 P

BESCHREIBUNG
DESCRIPTION



0-0901: Transparentes Kunststoff Etui mit Halterung aus Kunststoff. Der Kugelschreiber wird schwebend im Etui fixiert.

0-0909 P: Pappröhrenetui mit abnehmbarem Deckel in matt schwarz.

Werbeschlüssel 0-0901 TT

Werbeschlüssel 0-0909 P Schaft TT,
Kappe TT

0-0901: Transparent plastic case with plastic holding ring. The ballpoint pen is fixed floating in the case.

0-0909 P: Cardboard tube case with removable lid in matt black.

Advertising code 0-0901 TT

Advertising code 0-0909 P barrel TT,
cap TT

0-0901 ◊

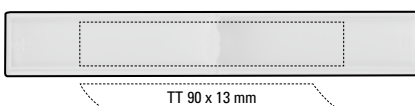

0-0909 P ◊





Das aus recycelten PET-Flaschen in Europa hergestellte rPET-Material eignet sich für einen langlebigen und nachhaltigen Werbeeinsatz. Dank der europäischen und ClimatePartner-zertifizierten Produktion leistet die uma RECYCLED PET BOX einen zusätzlichen nachhaltigen Beitrag zur Schonung der Umwelt.

0-2225: Verpackungs- und Präsentationsbox aus recyceltem PET-Material. Kann als POS-Aufsteller eingesetzt werden.



Werbeschlüssel TT

The rPET material, which is produced in Europe from recycled PET bottles, is suitable for a durable and sustainable advertisement. Thanks to the European and ClimatePartner-certified production, the uma RECYCLED PET PEN BOX makes an additional sustainable contribution to the protection of the environment.

0-2225: Packaging and presentation box made from recycled PET material. Can be used as a POS display.

Advertising code TT

Farb-Code (Minen)
Colour code (Refills)

- 57-2143 
- 57-CG11 
- 57-4268 



Unterseite: geprägtes Logo (alle Farben)
Underside: embossed logo (all colours)



Oberseite: geprägtes rPET-Logo (blau und grau)
Topside: embossed rPET-logo (blue and grey)



Oberseite: geprägtes "Social Plastic"-Logo (nur sandfarben)
Topside: embossed "Social Plastic"-logo (sand only)

Aufgrund der Besonderheiten des Materials (recyceltes PET-Material) sind produktionstechnische Farbschwankungen gegeben.

Due to the special nature of the material (recycled PET material) production-related variations are possible.

0-2225 

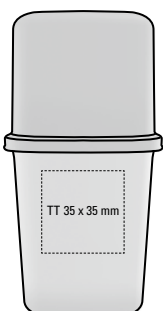

ETUI rPET
0-0955 rPET

BESCHREIBUNG
DESCRIPTION



0-0955 rPET: Etui aus recyceltem PET-Material für ein oder zwei Schreibgeräte.

Werbeschlüssel HD

0-0955 rPET: Case made from recycled rPET material for one or two writing instruments.

Advertising code HD

0-0955 rPET ◊

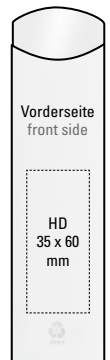

PAPPSTECKETUI
CARDBOARD SLIP-IN CASE
0-0942

BESCHREIBUNG
DESCRIPTION



0-0942: Pappstecketui aus FSC®-zertifiziertem Pappkarton in schwarz für zwei Schreibgeräte mit Stanzung.

Werbeschlüssel TT

0-0942: Cardboard slip-in case made from FSC® certified cardboard in black for two writing instruments with punching.

Advertising code TT

0-0942 ◊

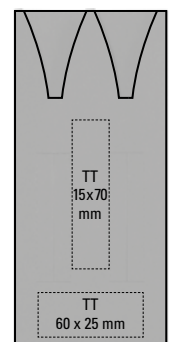

PAPPSTECKETUI
CARDBOARD SLIP-IN CASE
0-0940

PAPPSTECKETUI RECY
CARDBOARD SLIP-IN CASE RECY
0-0940 RECY

BESCHREIBUNG
DESCRIPTION



0-0940: Pappstecketui aus FSC®-zertifiziertem Pappkarton in schwarz oder weiß für ein Schreibgerät. Auch erhältlich mit dem Standardaufdruck: „Mit freundlicher Empfehlung – With compliments“.

0-0940 RECY: Pappstecketui aus FSC®-zertifiziertem Naturkarton für ein Schreibgerät, mit aufgedrucktem Recycling Hinweis auf der Rückseite. Farbschwankungen aufgrund des Recyclingprozesses gegeben.

Werbeschlüssel TT

0-0940: Cardboard slip-in case made from FSC® certified cardboard in black or white for one writing instrument without imprint or with the standard message: "Mit freundlicher Empfehlung – With compliments".

0-0940 RECY: Natural cardboard case made from FSC® certified cardboard for one writing instrument, with printed recycling information on the back. Colour variations may occur due to the recycling process.

Advertising code TT

PAPPSTECKETUI CI
CARDBOARD SLIP-IN CASE CI
0-0940 CI

BESCHREIBUNG
DESCRIPTION



0-0940 CI: Pappstecketui aus FSC®-zertifiziertem Pappkarton für ein Schreibgerät mit individuellem CI-Aufdruck.

Werbeschlüssel individuell

0-0940 CI: Cardboard slip-in case made from FSC® certified cardboard for one writing instrument with individual CI-imprint.

Advertising code individual

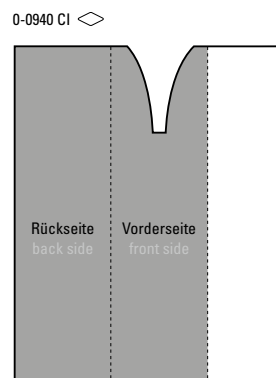

ETUI
0-0914/2

ETUI CI
0-0914/2 CI

BESCHREIBUNG
DESCRIPTION

0-0914/2: Etui mit EVA-Einlage für 2 Schreibgeräte mit transparent gefrostetem Kunststoffschuber.

0-0914/2 CI: Etui mit EVA-Einlage für 2 Schreibgeräte mit individuell gestaltbarem Kartonschuber.

Werbeschlüssel 0-0914/2

TT

Werbeschlüssel 0-0914/2 CI individuell

0-0914/2: Case with EVA inlay for two writing instruments with transparent frosted plastic slipcase.

0-0914/2 CI: Case with EVA inlay for two writing instruments with individual cardboard slipcase.

Advertising code 0-0914/2

TT

Advertising code 0-0914/2 CI individual

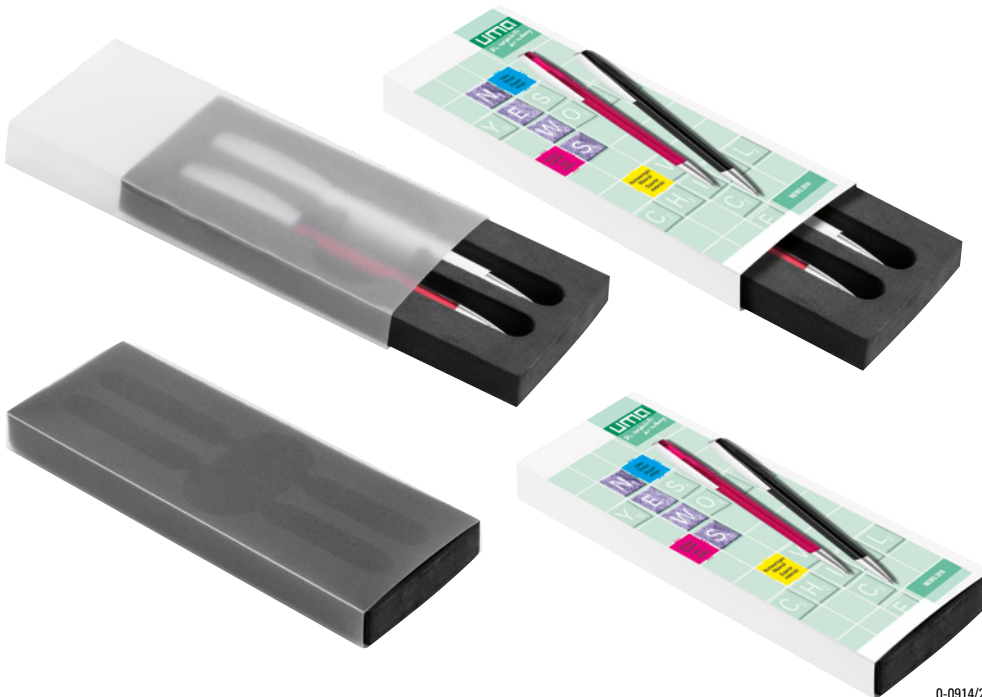

0-0914/2 ◊

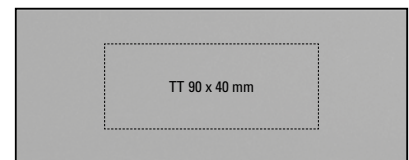

TT 90 x 40 mm

ETUI
0-0914

ETUI CI
0-0914 CI

BESCHREIBUNG
DESCRIPTION

0-0914: Etui mit EVA-Einlage für ein Schreibgerät mit transparent gefrostetem Kunststoffschuber.

0-0914 CI: Etui mit EVA-Einlage für ein Schreibgerät mit individuell gestaltbarem Kartonschuber.

Werbeschlüssel 0-0914

TT

Werbeschlüssel 0-0914 CI individuell

0-0914: Case with EVA inlay for one writing instrument with transparent frosted plastic slipcase.

0-0914 CI: Case with EVA inlay for one writing instrument with individual cardboard slipcase.

Advertising code 0-0914

TT

Advertising code 0-0914 CI individual



0-0914 ◊

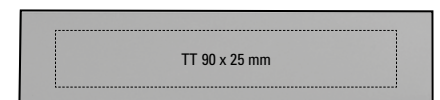

TT 90 x 25 mm



CASE
0-0918

BESCHREIBUNG
DESCRIPTION

287



0-0918: Zweiteiliges, schweres Pappetui in schwarz mit abnehmbarem Deckel, eingelassener Ziernaht in schwarz, schwarz glitzernd oder silber glitzernd, Kisseneinlage für ein oder zwei Schreibgeräte.

Werbeschlüssel TT/HD/RD

0-0918: Two-piece, heavy cardboard case in black with removable lid, decorative stitching in glossy black, black glittering or silver glittering and pillow inlay for one or two writing instruments.

Advertising code TT/HD/RD

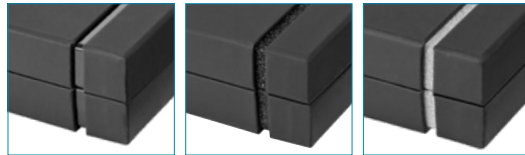

53-000B
black

53-00GB
glitter black

53-00GS
glitter silver



0-0918 ◊

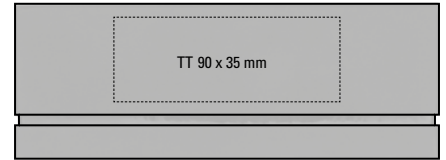

BOX
0-0944

BESCHREIBUNG
DESCRIPTION



0-0944: Zweiteiliges Pappetui mit abnehmbarem Deckel und W-Einlage für ein oder zwei Schreibgeräte.

Werbeschlüssel TT/HD/RD

0-0944: Two-piece cardboard case with removable lid and W-inlay for one or two writing instruments.

Advertising code TT/HD/RD



0-0944 ◊

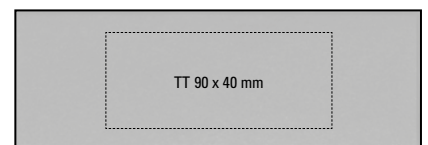

ETUI
0-0913 **new!**

BESCHREIBUNG
DESCRIPTION



0-0913: Klappetui in uni weiß, schwarz oder Carbonfaser-Look mit Magnetverschluss mit W-Einlage für ein, zwei oder drei Schreibgeräte. Kartonschuber in weiß. Auf Anfrage ist der Kartonschuber mit 4c-Gestaltung erhältlich.

Werbeschlüssel Etui TT, HD/RD
Schuber CI – Werbeschlüssel individuell

0-0913: Hinged case with magnetic closure in white, black or carbon fibre look and W-inlay for one, two or three writing instruments. Cardboard slippcase in white. On request the cardboard slippcase is available in a 4c-design.

Advertising code Etui TT, HD/RD
Schuber CI – Advertising individual

Farb-Code (Minen)
Colour code (Refills)

53-0002 
53-0001 
53-CARB 

0-0913 

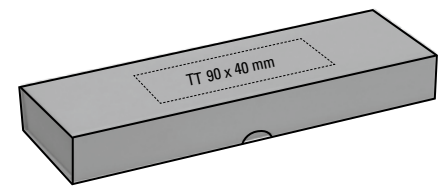

ETUI
0-0917

BESCHREIBUNG
DESCRIPTION

0-0917: Klappetui mit Magnetverschluss in schwarz für ein oder zwei Schreibgeräte.

Werbeschlüssel TT

0-0917: Hinged case with magnetic closure in black for one or two writing instruments.

Advertising code TT



0-0917 

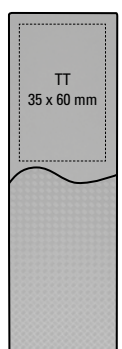

METALLETUI
0-0962 M

METALLETUI ML
0-0962 ML

BESCHREIBUNG
DESCRIPTION

289



0-0962 M: Metall-Klappetui in silber für ein oder zwei Schreibgeräte.

0-0962 ML: Metall-Klappetui für ein oder zwei Schreibgeräte mit lackierter Oberfläche in schwarz oder weiß.

Werbeschlüssel TT/L

0-0962 M: Metal hinged case in silver for one or two writing instruments.

0-0962 ML: Metal hinged case lacquered in black or white for one or two writing instruments.

Advertising code TT/L

0-0962 M, 0-0962 ML ◊



LEDERETUI
0-0900 LE

BESCHREIBUNG
DESCRIPTION



0-0900 LE: Schwarzes Lederetui für ein oder zwei Schreibgeräte mit silberfarbener Metallleiste.

Werbeschlüssel TT

0-0900 LE: Black leather case for one or two writing instruments with silver-coloured metal strip.

Advertising code TT

0-0900 LE ◊



MINEN

FILLS REF

MIN

REF



NEN **MINEN** MINEN MINEN
ILLS REFILLS **REFILLS** REFILLS

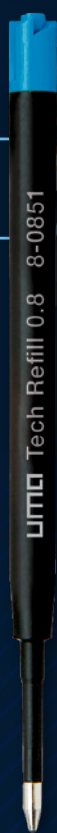

Die uma Qualitätsminen – lieber schreiben, besser werben The uma quality refill – better write, better promote

uma Minen – Qualität auf ganzer Linie

Die uma Qualitätsmine – das Herzstück jedes uma Schreibgerätes und somit auch einer der wichtigsten Gründe für nachhaltig erfolgreiche Werbekampagnen. uma steht für langanhaltenden Schreibgenuss und Minen, denen nicht so schnell die Puste ausgeht: Aus diesem Grund legen wir allergrößten Wert auf höchste Qualität – und gehen hier auch keine Kompromisse ein. Dank dem Einsatz deutscher Paste und Einhaltung der ISO NORM 12757-2 versprechen die uma Qualitätsminen ein unvergessliches Schreiberlebnis, besten Schreibkomfort und Dokumentenechtheit auf ganzer Linie.

uma refill – Quality all along the line

The uma quality refill – the heart of every uma writing instrument and thus one of the most important reasons for lastingly successful advertising messages. uma stands for long-lasting writing pleasure and refills that don't run out of ink so quickly: For this reason, we place the utmost importance on top quality – and we don't make any compromises here. Thanks to the use of German paste and compliance with ISO NORM 12757-2, uma quality leads promise an unforgettable writing experience, the best writing comfort and document authenticity across the board.

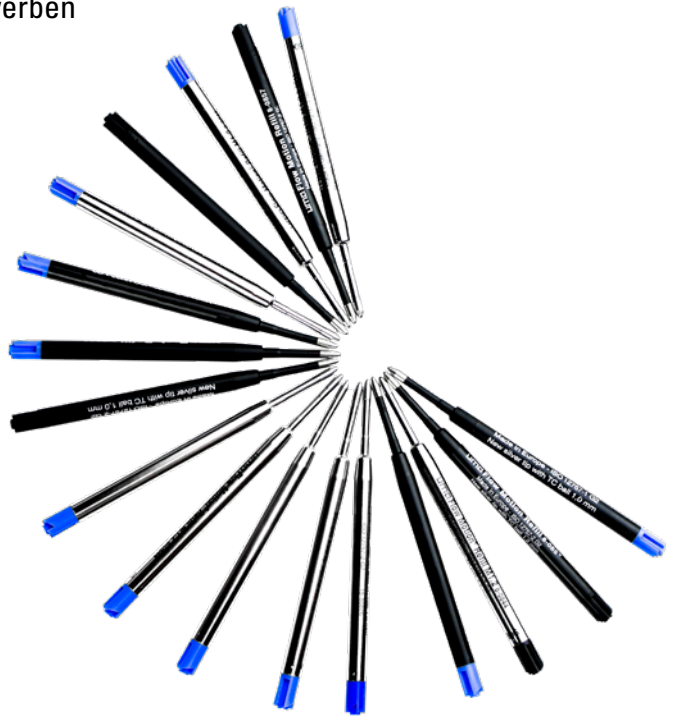

uma Qualitätsminen – Dokumental® inside!

Allen die eine uma Qualitätsmine schreiben garantieren wir Dokumental® inside. In Zusammenarbeit mit dem deutschen Pasten-Spezialisten Dokumental® fertigen wir eine Kombination aus feinsten Minentechnologie und bester Schreibpaste. Nur ein optimales Zusammenspiel aller Minenbauteile, ergibt das einzigartige uma Schreibgefühl. Alle Pasten und Minen entsprechen so nicht nur den REACH-Vorgaben sondern überzeugen auch in Strichfarbe, Strichstärke und Schreiblänge.

uma quality refills – Dokumental® inside!

We guarantee Dokumental® inside to all those who write an uma quality magazine. In cooperation with the German paste specialist Dokumental®, we produce a combination of the finest lead technology and the best writing paste. Only an optimal interaction of all lead components results in the unique uma writing experience. All pastes and leads not only comply with the REACH regulations, but also convince in line colour, line width and writing length.

Jede Handschrift zeichnet sich durch ihr individuelles Schriftbild aus. Ähnlich halten wir es auch mit der uma Mine. Je nach Wunsch finden Sie in unserem umfangreichen Minensortiment die beste Minenschreibtechnik für verschiedenste Schreibeigenschaften, passend zu unseren Modellvarianten. Aber ganz gleich ob mit Kugelschreiber-, Rollerballmine oder Patronen-Roller-System oder dem innovativen uma Tintenleitsystem – mit einer uma Mine schreiben Sie mit Sicherheit Qualität auf ganzer Linie.

Each handwriting is characterised by its individual typeface. We have a similar approach with the uma refill. Depending on your wishes, you will find the best refill writing technique for the most diverse writing characteristics in our extensive range of refills, matching our model variants. But no matter whether you use a biro refill, rollerball refill or cartridge rollerball system or the innovative uma ink feed system – with an uma refill you are sure to write quality all along the line.



uma Tech®

uma Tech® – unsere bewährte Qualitätsmine

Unsere uma Tech® Minen gelten seit langem als bewährte Wahl, wenn es um qualitativ hochwertiges und langanhaltendes Schreiben geht. Sie zeichnen sich aus durch ein sattes und konstant ausdrucksstarkes Schriftbild – eben Qualität, auf die man sich verlassen kann. Die uma Tech® Mine – die perfekte Verbindung von Technologie und Schreibfreude.

uma Tech® Refill 1.0, 8-0855 ■, 8-0856 □



Europäische Kunststoff-Großraummine mit weißem oder schwarzem Kunststoffrohr, Neusilberspitze und Wolfram-Karbid-Kugel (1.0 mm). Schreibleistung: ca. 4.500 m. Deutsche Schreibpaste von Dokumental® nach ISO-Norm ISO 12757-2, dokumentenecht. Die uma Tech Refill 1.0 vermittelt ein angenehmes und weiches Schreibgefühl.

European large-capacity plastic refill with white or black plastic tube, new silver writing tip and tungsten carbide ball (1.0 mm). Writing length: approx. 4,500 meters. German writing paste by Dokumental® according to ISO-Norm ISO 12757-2, document proofed. The uma Tech Refill 1.0 provides a pleasant and soft writing feeling.

4.500 m 1,0 mm

uma Tech® – our proven quality refill

The uma Tech® refills have long been considered a proven choice when it comes to high quality and long-lasting writing. They are characterized by a full and constant expressive writing style – quality you can rely on. The uma Tech® refill – the perfect combination of technology and writing pleasure.

uma Tech® Refill 1.0 XL, 8-0859 ■, 8-0860 □

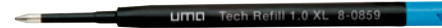

Europäische Kunststoff-Großraummine mit weißem oder schwarzem Kunststoffrohr, Edelstahlspitze und Wolfram-Karbid-Kugel (1.0 mm). Schreibleistung: ca. 5.500 m. Deutsche Schreibpaste von Dokumental® nach ISO-Norm ISO 12757-2, dokumentenecht. Die uma Tech Refill 1.0 XL vermittelt ein angenehmes und weiches Schreibgefühl.

European large-capacity plastic refill with white or black plastic tube, stainless steel tip and tungsten carbide ball (1.0 mm). Writing length: approx. 5,500 meters. German writing paste by Dokumental® according to ISO-Norm ISO 12757-2, document proofed. The uma Tech Refill 1.0 XL provides a pleasant and soft writing feeling.

5.500 m 1,0 mm

uma Tech® Refill 1.2, 8-0857 ■, 8-0858 □



Europäische Kunststoff-Großraummine mit weißem oder schwarzem Kunststoffrohr, Neusilberspitze und Wolfram-Karbid-Kugel (1.2 mm). Schreibleistung: ca. 3.500 m. Deutsche Schreibpaste von Dokumental® nach ISO-Norm ISO 12757-2, dokumentenecht. Die uma Tech Refill 1.2 kann in alle gängigen uma Schreibgeräte eingesetzt werden und verspricht pure Schreibfreude.

European large-capacity plastic refill with white or black plastic tube, new silver writing tip and tungsten carbide ball (1.2 mm). Writing length: approx. 3,500 meters. German writing paste by Dokumental® according to ISO-Norm ISO 12757-2, document proofed. The uma Refill 1.2 can be used in all standard writing instruments and promises great writing pleasure.

3.500 m 1,2 mm

uma Tech® Refill 0.8, 8-0851 ■, 8-0852 □



Europäische Kunststoff-Großraummine mit weißem oder schwarzem Kunststoffrohr, Neusilberspitze und Wolfram-Karbid-Kugel (0.8 mm). Schreibleistung: ca. 4.000 m. Deutsche Schreibpaste von Dokumental® nach ISO-Norm ISO 12757-2, dokumentenecht. Die uma Tech Refill 0.8 kann in alle gängigen uma Schreibgeräte eingesetzt werden und ist speziell für den feinen Strich besonders optimiert.

European large-capacity plastic refill with white or black plastic tube, new silver writing tip and tungsten carbide ball (0.8mm). Writing length approx. 4,000 meters. German writing paste by Dokumental® according to ISO-Norm ISO 12757-2, document proofed. The uma Tech Refill 0.8 can be used in all standard writing instruments and is specially optimized for fine strokes.

4.000 m 0,8 mm

uma FlowMotion®

uma FlowMotion® – schreibt, was sie verspricht!

Mit uma FlowMotion® bieten wir eine Mine, die schreibt, was sie verspricht: Das Zusammenspiel aus Minenspitze, Minenkugel und die perfekt zusammengesetzte Schreibpaste lassen ein unvergessliches Schreibgefühl entstehen. Eleganter war Schreiben noch nie: Gleiten Sie sanft über das Papier und wecken Sie mit Ihrer Handschrift pure Emotionen – uma FlowMotion®.

uma FlowMotion® Refill M1.2, 8-0844



Europäische Metall-Großraummine mit Edelstahlspitze und Wolfram-Karbid-Kugel (1.2 mm). Schreibleistung ca. 4.000 m. Deutsche Schreibpaste nach ISO-Norm. Made in Germany. Das Zusammenspiel aus Minenspitze, Minenkugel und perfekt zusammengesetzte Schreibpaste lassen ein unvergessliches Schreibgefühl entstehen.

European large-capacity metal refill with stainless steel tip and tungsten carbide ball (1.2 mm). Writing length approx. 4,000 meters. German ISO-compliant ink paste. Made in Germany. The interplay of lead tip, lead ball and the perfectly composed writing paste create an unforgettable writing experience.

4.000 m 1,2 mm

uma FlowMotion® – writes what it promises!

With uma FlowMotion® we offer a refill that writes what it promises: the combination of refill tip, refill ball and the perfectly composed writing paste create an unforgettable writing experience. Writing has never been more elegant: Slide gently over the paper and arouse pure emotions with your handwriting – uma FlowMotion®.

uma FlowMotion® Refill K1.0, 8-0840



Europäische Kunststoff-Großraummine mit weißem oder schwarzem Kunststoffrohr, Neusilberspitze und Wolfram-Karbid-Kugel (1.0 mm). Schreibleistung: ca. 1.200 m. Deutsche Schreibpaste nach ISO-Norm. Das Zusammenspiel aus Minenspitze, Minenkugel und die perfekt zusammengesetzter Schreibpaste lassen ein unvergessliches Schreibgefühl entstehen.

European large-capacity plastic refill with white or black plastic tube, new silver writing tip and tungsten carbide ball (1.0 mm). Writing length: approx. 1,200 meters. German ISO-compliant ink paste. The interplay of lead tip, lead ball and the perfectly composed writing paste create an unforgettable writing experience.

1.200 m 1,0 mm

uma X-20, Jumbo und Extra Class Minen – perfekt angepasst an Ihre Bedürfnisse

Die Mine eines Schreibgerätes muss nicht nur zur jeweiligen Form passen. Auch die Schreibgewohnheiten können unterschiedlich sein. Bei uma erhalten Sie eine breite Palette an Möglichkeiten: Neben der klassischen uma Tech® Mine bieten wir mit der uma X-20, Jumbo und Extra Class Refill weitere hochwertige Minen mit Schreiblängen von 2.000 bis 10.000 Meter.

uma X-20, Jumbo and Extra Class refills – perfectly adapted to your needs.
The refill of a writing instrument does not only have to fit the respective design. The writing habits can also be different. At uma you will find a wide range of possibilities: In addition to the classic uma Tech® refill, we offer the uma X-20, Jumbo and Extra Class Refill, other high-quality refills with writing lengths from 2,000 to 10,000 meters.

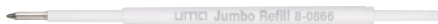
uma Jumbo Refill, 8-0866

Europäische Jumbo Mine mit weißem Kunststoffrohr, silberner Schreibspitze und Wolfram-Karbid-Kugel (1.0 mm). Schreibleistung: ca. 2.500 m. Deutsche Schreibpaste von Dokumental® nach ISO-Norm ISO 12757-2, dokumentenecht.

European Jumbo refill with white plastic tube, silver writing tip and tungsten carbide ball (1.0 mm). Writing length: approx. 2,500 meters. German writing paste by Dokumental® according to ISO-Norm ISO 12757-2, document proofed.

2.500 m 1,0 mm

uma X-20 Refill, 8-0877

Europäische X-20 Kunststoffmine, mit weißem Kunststoffrohr, silberner Schreibspitze und Wolfram-Karbid-Kugel (1.0 mm). Schreibleistung: ca. 2.000 m. Deutsche Schreibpaste von Dokumental® nach ISO-Norm ISO 12757-2, dokumentenecht.

European X-20 refill with white plastic tube, silver writing tip and tungsten carbide ball (1.0mm). Writing length: approx. 2,000 meters. German writing paste by Dokumental® according to ISO-Norm ISO 12757-2, document proofed.

2.000 m 1,0 mm

uma Extra Class Refill, 8-0888

Europäische Metall-Großraummine mit Edelstahl-Schreibspitze und Wolfram-Karbid-Kugel (1.0 mm). Schreibleistung: ca. 10.000 m. Deutsche Schreibpaste von Dokumental® nach ISO-Norm ISO 12757-2, dokumentenecht. Made in Germany.

European large-capacity metal refill with stainless steel tip and tungsten carbide ball (1.0mm). Writing length: approx. 10,000 meters. German writing paste by Dokumental® according to ISO-Norm ISO 12757-2, document proofed. Made in Germany.

10.000 m 1,0 mm

Die uma Rollerballminen – gleiten förmlich über das Papier!

Rollerballminen zeichnen sich durch ein besonders gleichmäßiges und flüssiges Schriftbild aus. Ebenso elegant ist das subjektive Schreib-Empfinden: Rollerballminen verleihen der persönlichen Handschrift eine leichte und sanfte Note. Mit der uma High Class Rollerball Mine vertrauen Sie auf eine Schreibqualität, die angenehmer kaum sein kann.

The uma rollerball refills – literally sliding over the paper

The rollerball refills are characterized by a particularly even and fluid writing style. The subjective writing feeling is just as elegant: rollerball refills provide a light and gentle touch to personal handwriting. With the uma High Class Rollerball refill you can rely on a writing quality that could hardly be more pleasant.

uma High Class Rollerball Refill, 8-0806

Europäische Rollerball-Mine mit Edelstahl-Schreibspitze und Keramik Karbid-Kugel (0.7 mm). Schreibleistung: ca. 800 m. Deutsche Schreibpaste. Made in Germany. Die uma Rollerball-Mine trocknet auch bei abgezogener Kappe nicht sofort aus. Deshalb bescheinigen wir eine extra lange „cap-off“-Zeit.

European rollerball refill with stainless steel writing tip and ceramic ball (0.7 mm). Writing length: approx. 800 meters. German writing paste. Made in Germany. The refill does not dry out immediately, even without the cap, which is why we can testify that it has an extra-long "cap-off" time.

800 m 0,7 mm

uma Tintenpatrone

Die Tintenpatrone, 8-0891 eignet sich ideal für die Verwendung in gängigen Füllfederhaltern. Sie enthält schnell fließende Tinte, die ein gleichmäßiges und sauberes Schreibgefühl gewährleistet. Die Patrone ist einfach zu wechseln und garantiert eine lange Schreibdauer.

uma cartridges

The ink cartridge 8-0891 is ideal for use with most fountain pens. It contains fast-flowing ink that ensures a smooth and consistent writing experience. The cartridge is easy to replace and provides a long writing duration.

uma Tintenpatrone, 8-0891



Tintenpatronen für Füllfederhalter.
uma cartridges for the fountain pens.



uma Tintenleitsystem

Das **uma Tintenleitsystem** bietet die Lösung für verschiedene Schreibsysteme in gleichen Modellgehäusen. Ein Tank für Rollerball-, Highlighter- oder Fineliner-Paste in Kombination mit dem innovativen uma Tintenleitsystem ergibt eine höchst flexible Lösung für individuellen Schreibkomfort. Alle verwendeten Pasten sind nach EN-71-3, ASTM D-4236 produziert. Kein Anstechen und eine lange „Cap off“ Zeit versprechen sofortigen und anhaltenden Schreibgenuss. Alle uma Tintenleitsysteme können nachbestellt werden und sind im Schreibgerät einfach auszutauschen. Schreiben und markieren wird so zur „Never Ending Story“.

uma ink transfer system

The **uma ink flow system** offers the solution for different writing systems in the same model. A tank for rollerball, highlighter or fineliner paste in combination with the innovative uma ink guiding system provides a highly flexible solution for individual writing comfort. All pastes used are produced according to EN-71-3, ASTM D-4236. No piercing and a long "cap off" time promise immediate and lasting writing pleasure. All uma ink systems can be reordered and are easy to replace in the writing instrument. Writing and marking becomes a "Never Ending Story".

Tintenleitsystem LIQEO Highlighter, 8-0820



Tintenleitsystem für Flüssighighlighter LIQEO mit integriertem Flüssigkeitstank. Das Highlightersystem ist ohne Pumpen oder Anstechen sofort einsatzfähig. Die Documental® Highlighterpaste garantiert bessere Schreibqualität – höhere Leuchtkraft – längere Schreibdauer und ist umweltfreundlicher als herkömmliche Tamponhighlighter, sowie produziert nach EN-71-3, ASTM D-4236.

Ink flow system for liquid highlighter LIQEO with integrated liquid tank. The highlighter system can be used immediately without pumping or injection. The Documental® highlighter paste guarantees better writing quality – higher luminosity – longer writing duration and is more environmentally friendly than conventional tampon highlighters. It is also produced according to EN-71-3, ASTM D-4236.

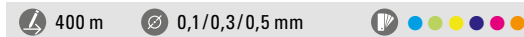

Tintenleitsystem Fineliner, 8-0821



Tintenleitsystem für Fineliner mit integriertem Flüssigkeitstank. Das Finelinersystem ist ohne Pumpen oder Anstechen sofort einsatzfähig. Die Finelinerpaste in Kombination mit der Finelinerspitze (0.4 mm) ermöglicht präzises Schreiben und Markieren und ist nach EN-71-3, ASTM D-4236 produziert.

Ink flow system for fineliner with integrated liquid tank. The fineliner system can be used immediately without pumping or injection. The fineliner paste in combination with the fineliner tip (0.4mm) enables precise writing and marking and is produced according to EN-71-3, ASTM D-4236.



Tintenleitsystem Rollerball, 8-0822



Tintenleitsystem für Rollerball mit integriertem Flüssigkeitstank. Das Rollerballsystem ist ohne Pumpen oder Anstechen sofort einsatzfähig. Die Rollerballpaste in Kombination mit der TC Rollerballschreibspitze (0.7 mm) sorgt für feines und flüssiges Schreiben und ist nach EN-71-3, ASTM D-4236 produziert.

Ink flow system for rollerball with integrated liquid tank. The rollerball system can be used immediately without pumping or injection. The rollerball paste in combination with the TC rollerball writing tip (0.7 mm) ensures fine and fluid writing and is produced according to EN-71-3, ASTM D-4236.

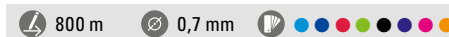

Sauberes Schriftbild für jedes Budget

Die uma Economy-Minen verbinden Schreibqualität mit Budgetvorgaben. So muss bei den uma Economy-Minen nicht auf die uma Schreibqualität verzichtet werden. Für den kleineren Preis sind allerdings kürzer Schreibblängen anzusetzen.

Perfect caption for each budget

uma Economy refills combine writing quality with budget targets. This means that uma Economy refills do not have to do without uma writing quality. For the smaller price, however, shorter writing lengths should be used.

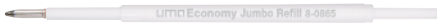
uma Economy Jumbo Refill, 8-0865

Jumbo Mine mit weißem Kunststoffrohr, silberner Schreibspitze und Wolfram-Karbid-Kugel (1.0 mm). Schreibleistung: ca. 1.200 m. Schreibpaste nach ISO-Norm.

Jumbo refill with white plastic tube, silver writing tip and tungsten carbide ball (1.0 mm). Writing length: approx. 1,200 meters. ISO-compliant ink paste.

1.200 m 1,0 mm

uma Economy X-20 Refill, 8-0875

X-20 Kunststoffmine, mit weißem Kunststoffrohr, silberner Schreibspitze und Wolfram-Karbid-Kugel (1.0 mm). Schreibleistung: ca. 1.000 m. Schreibpaste nach ISO-Norm.

X-20 refill with white plastic tube, silver writing tip and tungsten carbide ball (1.0 mm). Writing length: approx. 1,000 meters. ISO-compliant ink paste.

1.000 m 1,0 mm

uma Economy Refill, 8-0854

Kunststoff-Großraummine mit weißem Kunststoffrohr, silberner Schreibspitze und Wolfram-Karbid-Kugel (1.0 mm). Schreibleistung: ca. 1.500 m. Schreibpaste nach ISO-Norm.

Large-capacity plastic refill with white plastic tube, silver writing tip and tungsten carbide ball (1.0 mm). Writing length: approx. 1,500 meters. German ISO-compliant ink paste.

1.500 m 1,0 mm

uma Economy Class Refill, 8-0883

Metall-Großraummine mit Neusilberspitze und Wolfram-Karbid-Kugel (1.0 mm). Schreibleistung: 3.500 m. Schreibpaste nach ISO-Norm.

Large-capacity metal refill with new silver tip and tungsten carbide ball (1.0 mm). Writing length: 3,500 meters. ISO-compliant ink paste.

3.500 m 1,0 mm

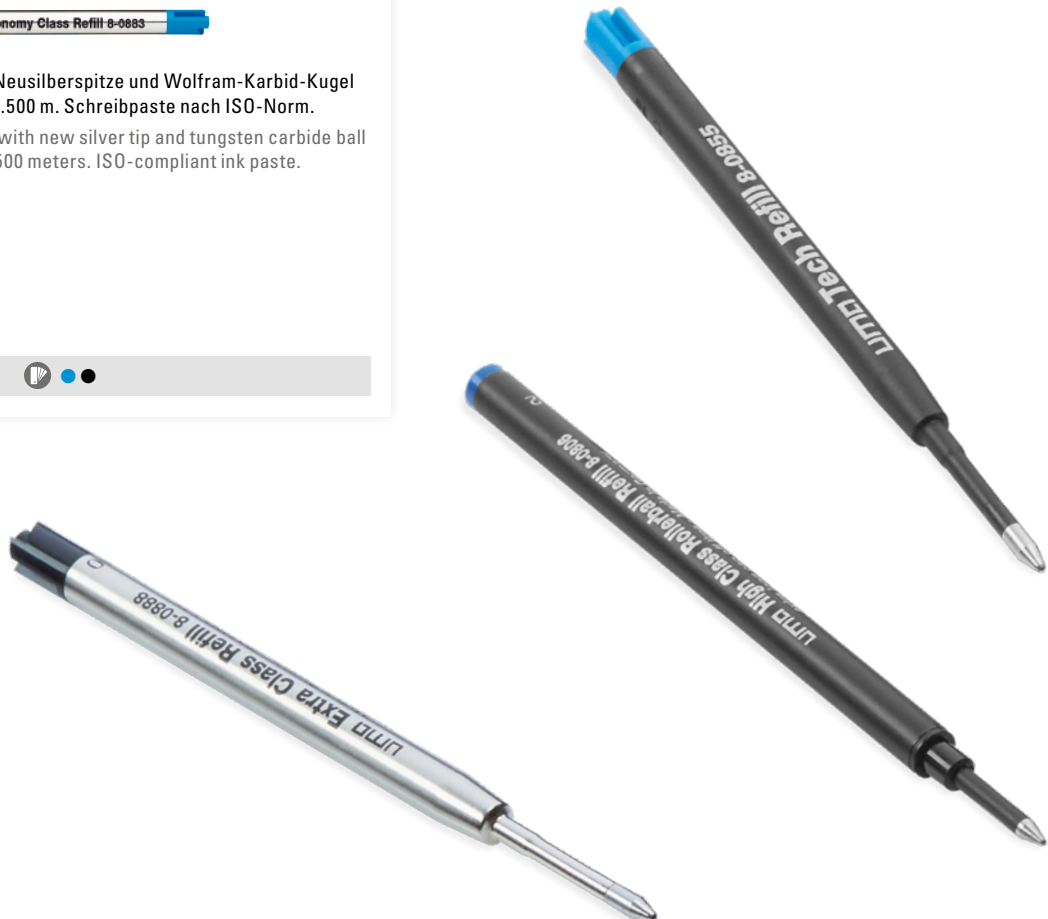

Für den ganz speziellen Strich geeignet

Mit den uma Spezial-Minen bieten wir Ihnen neben weiteren Schreibeigenschaften auch andere Minen an, die das Schreiben in Sonderformaten ermöglichen. Auch hier müssen Sie auf gewohnten uma Schreibkomfort nicht verzichten.

Suitable for the very special stroke

With uma special refills, we offer you besides other writing characteristics also other refill designs that allow writing in special forms. Here, you do not have to do without the usual uma writing comfort.

uma High Class Refill, 8-0886



Europäische Metall-Großraummine mit Edelstahl-Schreibspitze und Wolfram-Karbid-Kugel (1.0 mm). Schreibleistung: ca. 10.000 m. Deutsche Schreibpaste von Dokumental® nach ISO-Norm ISO 12757-2, dokumentenecht. Made in Germany.

European large-capacity metal refill with stainless steel tip and tungsten carbide ball (1.0 mm). Writing length: approx. 10,000 meters. German writing paste by Dokumental® according to ISO-Norm ISO 12757-2, document proofed. Made in Germany.

10.000 m 1,0 mm ● ●

uma D1 Refill, 8-0894



Metall D1 Mine mit Metallrohr und Edelstahlspitze (1.0 mm). Schreibleistung: ca. 600 m.

Metal-D1 refill with metal tube and stainless steel tip (1.0 mm). Writing length: approx. 600 meters.

600 m 1,0 mm ● ●



LUNG DRUCK & VEREDELUNG
ING PRINTING WISHING



DRUCK & VEREDELUNG PRINTING & FINISHING

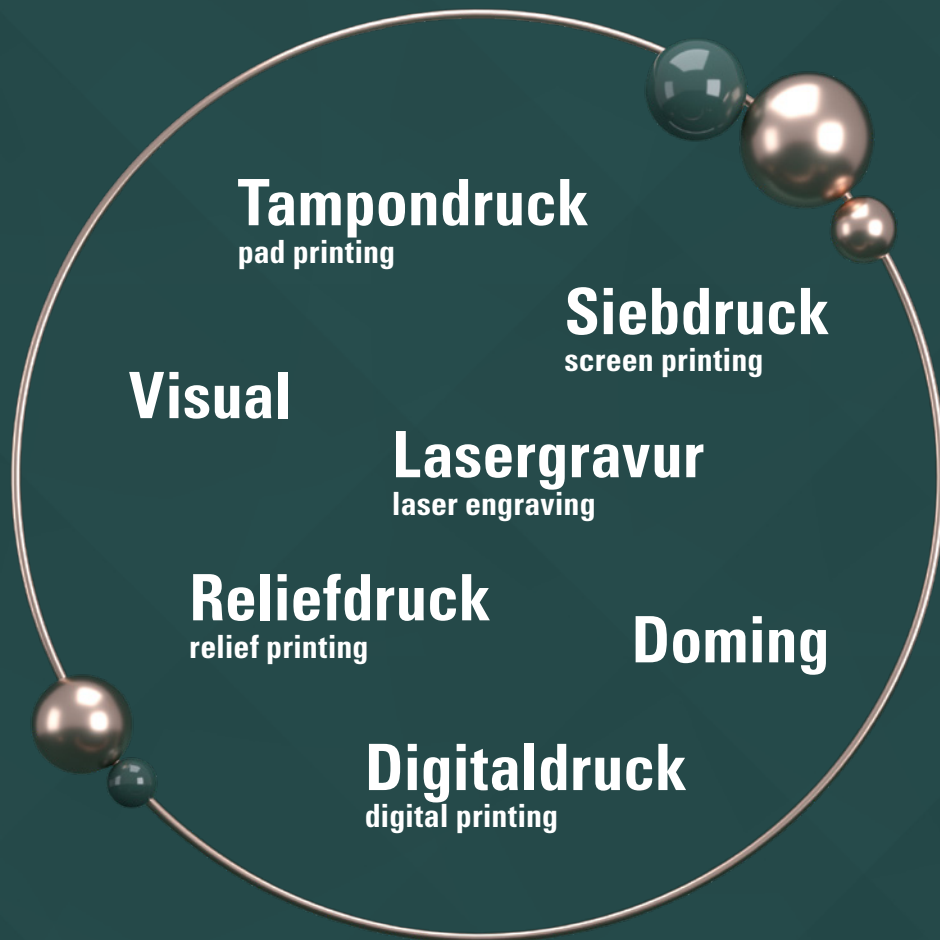

So werden aus Schreibgeräten elegante Werbeträger

Unser Ziel ist es aus dem Schreibgerät einen optimalen Werbeträger zu erzeugen. Hierzu verwenden wir den innovativsten und modernsten Veredelungspark Europas. Unsere langjährige Erfahrung geben wir gerne an unsere Kunden weiter, um die Zufriedenheit nachhaltig sicherzustellen. Für die Erzielung des optimalsten Druckergebnisses kann es nötig sein den Druck weiß zu unterlegen oder einen Doppeldruck umzusetzen. In diesen Fällen stimmen wir zusätzliche Druckkosten mit Ihnen ab.

Je nach Farbgebung bzw. Materialbeschaffenheit (transparente Gehäuse) empfehlen wir Druckfarben einzusetzen, die in einem starken Kontrast zur Schreibgerätefarbe stehen. Dies optimiert die Sichtbarkeit und die Lesbarkeit des Druckes.



Siebdruck (S, MS, GS)

Die gängigste und rationellste Form der Schreibgeräteveredelung findet zumeist Einsatz für den Schaftdruck. Aus der Druckvorlage wird ein Film generiert und durch einen photochemischen Prozess auf das Sieb aufgetragen. Dabei werden lediglich die zu druckenden Partien farbdurchlässig – und erscheinen so durch einen Pressvorgang auf dem Werbeträger.

Mit dem Siebdruck ist es möglich, mehrfarbige Rundumdrücke zu gestalten und somit die Werbefläche des Kugelschreibers optimal zu nutzen. Dabei lassen sich sowohl Strich- als auch Rastervorlagen (33er bis 48er Raster) auf allen Materialien umsetzen.



Tampondruck (T, MT, GT, TT)

Der Tampondruck ermöglicht Drucke auf konkaven und konvexen Flächen. Somit findet er überwiegend Einsatz für den Clipdruck bzw. mehrfarbigen Bilderdruck. Aus der Druckvorlage wird ein Film generiert und daraus wiederum ein Klischee erstellt. Mittels eines Tampons (gummierter Stempel) wird die Farbe vom Klischee auf den Werbeträger übertragen.

Die Werbefläche, die so ausgeschöpft werden kann, weist bei zylindrischen Schreibgeräten eine maximale Höhe von 2/3 des Durchmessers auf. Der Tampondruck kann auf allen Materialien eingesetzt werden.



Lasergravur (L, RL, EL)

Die Lasertechnik eröffnet ganz neue Produktionsmöglichkeiten, weil hier noch feinere und präzisere Bearbeitungen möglich sind, und das in allen Materialien. Vor allem bei Metalloberflächen spielt der Laser seine ganze Stärke aus, indem er millimetergenau eine feine Schicht der Kugelschreiberoberfläche abträgt. Personalisierungen oder Rundumgravuren sind im uma Programm Dank der modernsten Lasertechnik auch hochglänzend umsetzbar.



uma Digitaldruck (HD)

Schnell, direkt und persönlich auf Ihre Kunden Eindruck machen – im Digitaldruck lässt sich Ihr Wunsch-Kugelschreiber ganz einfach realisieren. Vorhang auf für Ihre Ideen und unterschiedlichen Werbebotschaften: Bunte Logos, Farbverläufe und Gradierungen, und das auch in geringen Stückzahlen – so flexibel ist kaum eine andere Drucktechnik. Zu beachten ist lediglich, dass die Farbwerte, die hier in CMYK umgewandelt werden, von den exakten PMS-Farben leicht abweichen können. Die Drucktechnik ist auf flache Ebenen beschränkt und kann nicht für konkave oder konvexe Flächen eingesetzt werden.

Die Haftfähigkeit von Druckfarben auf Kunststoffmodellen kann nicht mit den besonderen Oberflächenbeschaffenheiten von Metallschreibgeräten (Druckschlüssel MT/MS) oder gummierten Softtouch-Oberflächen (Druckschlüssel GT) verglichen werden.

Die Druckergebnisse auf diesen Oberflächen sind grundsätzlich stabil, es gelten jedoch höhere Abriebwahrscheinlichkeiten und eine geringere Kratzfestigkeit, als bei Drucken auf Kunststoffen.



uma VISUAL Folientransferdruck (V)

Von Produktdarstellungen und Anzeigenmotiven über eigene Designentwürfe bis hin zu ganzen Bildwelten – die neue Veredelungstechnik uma VISUAL eröffnet nahezu grenzenlose individuelle Gestaltungsmöglichkeiten um den kompletten Kunststoffschaff herum. Die Trägerfolie gibt unter Druck und Hitzeeinwirkung das Druckmotiv auf den Schaft ab. Das „aufgebügelte“ Motiv umschließt den Schaft komplett (360 Grad-Druck).



uma Reliefdruck (RD)

Fühlen Sie Ihre Werbebotschaft. Mit dem Reliefdruck wird jedes Logo greifbar. Zusätzlich zu einem normalen Tampon-, Sieb-, oder Digitaldruck wird ein klarer UV-Lack über das Logo gezogen. Die zusätzliche Lackschicht gibt dem Logo eine 3D-Optik und einen besonderen Glanz.



Doming (D)

Das Herstellungsverfahren einer gewölbten, dekorativen, dreidimensionalen Oberflächenbeschichtung nennt man Doming. Diese Beschichtung besteht aus Kunstharz und besitzt in der Regel eine gläserne hochtransparente Optik. Dies verstärkt die ästhetische Wirkung eines Motives und kann sowohl auf Kunststoff als auch auf Metallschreibgeräten aufgeklebt werden.

Druckvorlagen

Für ein optimales Druckergebnis bedarf es optimaler Druckvorlagen. Für die verschiedenen Veredelungstechniken benötigen wir vektorisierte Druckdateien mit einer Mindestauflösung zwischen 600 und 1.200 dpi – optimal sind EPS-Daten. Weiter eignen sich TIFF- oder JPG-Daten mit gleicher Auflösung.

Gestellte Filme können nur nach Prüfung der hausinternen Repro-Abteilung und lediglich im Fall des Siebdruckes eingesetzt werden.

Für Mehrfarbdrucke, Rasterdrucke und Tampondrucke können nur hauseigene Filme verwendet werden.

Datenübertragung

In unserem Hause können folgende Softwareversionen verarbeitet werden: Adobe Photoshop, Adobe Illustrator und InDesign. Zur Datenübertragung können die uma Cloud oder E-Mail genutzt werden. Aus Sicherheitsgründen und evtl. Rückfragen bitten wir bei der Datenübertragung immer um Angabe der Firma, Telefon und Auftragsnummer.

This is how writing instruments become elegant advertising media!

Our mission is to create an optimal writing advertising medium. For this we use the most innovative and modern finishing park in Europe. We are happy to share our many years of experience with you to ensure satisfaction in the long term.

In order to achieve the best printing results it may be necessary to underlay the print with white or to implement a double print. In these cases we will coordinate additional printing costs with you.



Silk printing (S, MS, GS)

This is the most popular and efficient method of finishing writing instruments by printing on the barrel. The image to be printed will be generated from the artwork and then applied to the screen using a photochemical process. In this process, only the areas of printing are permeable to ink, causing images to appear on the print substrate by means of a pressing process. With screen printing it is possible to achieve multi-colour and all-round prints, which makes optimum use of the promotional surface of the ballpoint pen. This means, that line as well as grid templates can be implemented. Please contact our experts if you require further detailed information.



Pad Printing (T, MT, GT, TT)

Pad printing allows to print on concave and convex surfaces. When it comes to printing on clips it's mostly done by pad printing or multi-coloured image printing. A film will be generated from the artwork, thereof a cliché will be created. By using a silicone pad (like a rubbered stamp) the colour will be transferred from the cliché onto a substrate. The advertising surface of cylindrical writing instruments have a maximum height of 2/3rds of the diameter. Pad printing can be used on any material.



Laser technology (L, RL, EL)

The laser technology opens up completely new possibilities of manufacturing because even finer and more precise processing are possible, with any materials. Especially with metal surfaces, the laser shows its full strength, by removing accurate to the millimetre a fine layer of the writing instruments surface. Thanks to the latest laser technology, high-gloss personalisation and 360°-engraving are included in the uma assortment.



uma Digital printing (HD)

Impress your customers – rapidly, directly and with a personal touch – digital printing enables your desired ballpoint pen to be created very simply. Curtains up for your ideas and on a gamut of promotional messages: Brightly coloured logos, colour schemes and gradations, even in small production runs – virtually no other printing technique delivers this level of flexibility. All you need to consider is, the colour shades which will here be converted into CMYK, may vary slightly from the exact PMS colours. The printing technology is limited to plane surfaces and can't be used on concave and convex surfaces.

Depending on colour or material (transparent housing) we recommend the use of printing inks with a high contrast to the colour of the pen. This optimizes visibility and the legibility of the print.

The durability of printing inks on plastic models can be not compare with the special surface qualities of metal writing instruments (pressure key MT/MS) or rubberised soft-touch surfaces (pressure key GT).

The printing results on these surfaces are basically stable, but higher abrasion probabilities apply and a lower scratch resistance than prints on plastics.



uma VISUAL foil transfer printing (V)

Product images, advertisement motifs, your own design drafts and entire image portfolios – the new uma VISUAL finishing method opens up almost endless individual design choices all around the entire barrel of plastic writing instruments. Under pressure and the effect of the heat, the carrier foil transports the print onto the barrel. The pressed motif covers the barrel completely (360 degree-print).



uma relief print (RD)

Feel your advertising message. With the relief print any logo becomes tangible. Additional to normal pad, silk or digital printing the logo will be covered by a clear UV lacquer. The additional special lacquer gives the logo a visual 3D effect and a special glance.



Doming (D)

The manufacturing process of a curved, decorative, three-dimensionally surface coating is called doming. The coating consists of synthetic resin and usually has a glassy high transparent visual effect. This effect intensified the aesthetic impression of the motif. It can be placed on plastic as well as on metal writing instruments.

Printing templates

An optimal printing result requires optimal printing templates. For the different finishing technologies we need vectorised print files with a minimum resolution between 600 and 1,200 dpi – optimal are EPS-files. TIFF or JPG files with a similar resolution are also suitable.

Provided films can only be used after examination of our in-house graphic department and also in case of screen printing. For multicolour-, halftone- and pad printing only in-house films can be used.

Data transmission

We are able to work with the following software versions: Adobe Photoshop, Adobe Illustrator and InDesign.

For data transmission you could use the uma Cloud or via E-Mail. For safety reasons and potential inquiries with data transmission we ask for company information, telephone and order number.

Art.-Nr. Item No	Modell Model	Stiftfarben/Colours										Seite Page	
		Silber Silver	Schwarz Black	Weiß White	Blau Blue	Rot Red	Anthrazit Grey	Grün Green	Edelstahl Stainless steel	Glanz- chrom Silver gloss	weitere Farben additional colours		
0-0196 L	RONDO CHROM L												256
0-0962 M	METALLETUI												289
0-0962 ML	METALLETUI												289
0-2622	ZINI												267
0-6100	VIPOLINO												215
0-7200	ALUMA												55
0-7200 T	ALUMA transparent												55
0-8240	SUPREME												259
0-8242 R	SUPREME R												259
0-8250	SLIMLINE												261
0-8250 DOM	SLIMLINE DOM												261
0-8320	SHADOW												263
0-8322 R	SHADOW R												263
0-8330	SIX												252
0-8340	SLIDE												265
0-8340 TO	SLIDE TOUCH												265
0-8342 R	SLIDE R												265
0-8350	SMOKE												253
0-8370	ETERNITY												223
0-8370 M	ETERNITY M												223
0-8372 MR	ETERNITY MR												223
0-8372 R	ETERNITY R												223
0-8800 M	CLASSICO M												226
0-8940 C	GALILEO C												222
0-9100	VIP												217
0-9100 GO	VIP GO												217
0-9100 GUM	VIP GUM												216
0-9102 R	VIP R												217
0-9102 R GUM	VIP R GUM												216
0-9106 F	VIP F												217
0-9107 B	VIP B												217
0-9190	ELEGANCE												221
0-9190 C	ELEGANCE C												220
0-9190 GO	ELEGANCE GO												221
0-9190 LUX	ELEGANCE LUX												220
0-9190 M	ELEGANCE M												221
0-9190 WOOD	ELEGANCE WOOD												91
0-9340 C	MOOD C												211
0-9340 GUM	MOOD GUM												210
0-9342 R C	MOOD R C												211
0-9342 R GUM	MOOD R GUM												210
0-9350	MESH												213
0-9352 R	MESH R												213
0-9360	TITAN ONE												219
0-9362 R	TITAN ONE R												219
0-9360 M	TITAN ONE M												218
0-9362 MR	TITAN ONE MR												218
0-9370	TITAN WOOD												89
0-9372 R	TITAN WOOD R												89
0-9412	TAROT												255
0-9415	LUCKY												257
0-9438	COMMA												257
0-9440	COSMOS												256
0-9450	STRAIGHT												241

Art.-Nr. Item No	Modell Model	Stiftfarben/Colours										Seite Page	
		Silber Silver	Schwarz Black	Weiß White	Blau Blue	Rot Red	Anthrazit Grey	Grün Green	Edelstahl Stainless steel	Glanz- chrom Silver gloss	weitere Farben additional colours		
0-9450 GUM	STRAIGHT GUM		✳		✳	✳			✳			✳	240
0-9450 GUM RECY	STRAIGHT GUM RECY		■										95
0-9450 M GUM RECY	STRAIGHT M GUM RECY		■										95
0-9450 M GUM	STRAIGHT M GUM		✳										240
0-9450 GO	STRAIGHT GO		■	■									243
0-9450 RO GO	STRAIGHT RO GO		■	■									243
0-9450 RO GO GUM	STRAIGHT RO GO GUM		■										243
0-9450 SI	STRAIGHT SI	✳	✳	✳	✳	✳			✳	■		✳	239
0-9450 SI GUM	STRAIGHT SI GUM											✳	239
0-9450 SI TO	STRAIGHT SI TO	✳	✳	✳	✳	✳			✳			✳	238
0-9452 R SI TO	STRAIGHT SI R TO	✳	✳	✳	✳	✳			✳			✳	238
0-9457 B	STRAIGHT B	✳	✳	✳	✳		✳						241
0-9457 GUM B	STRAIGHT GUM B		✳		✳	✳			✳			✳	240
0-9457 SI B	STRAIGHT SI B	✳	✳	✳	✳	✳			✳			✳	239
0-9460	VENUS	□	□		□	□			□				254
0-9470	MOON	□	□	□	□	□			□				254
0-9480 L	ARGUS L	□	□		□	□			□				255
0-9530 RECY	GROOVE RECY	□	□	□	□	□			□			□	99
0-9530 M RECY	GROOVE M RECY		□	□									99
0-9530 TO RECY	GROOVE TOUCH RECY	□	□	□	□	□			□			□	99
0-9540 GUM	ELLIPSE GUM		✳		✳	✳	✳		✳			✳	237
0-9540 SI	ELLIPSE SI											✳	236
0-9560 GUM	LUMOS GUM		✳		✳	✳			✳			✳	247
0-9560 M GUM	LUMOS M GUM		■		■	■			■			■	247
0-9560 RECY	LUMOS RECY	□	□	□	□	□	□	□	□			□	97
0-9560 STONE	LUMOS STONE						□					□	249
0-9575	PRIMUS	□	□	□	□	□			□			□	251
0-9588 TO	SKINNY TOUCH	□	□	□	□				□			□	269
0-9588 M TO	SKINNY M TOUCH		□										269
0-9610 GUM	BRUSH GUM		✳		✳	✳			✳			✳	233
0-9612 R GUM	BRUSH R GUM		✳		✳	✳			✳			✳	233
0-9630 GUM	BRIGHT GUM		✳		✳	✳			✳		■	✳	235
0-9630 F GUM	BRIGHT F GUM		✳		✳	✳			✳			✳	235
0-9733	PYRA	✳		✳									245
0-9733 GUM	PYRA GUM		✳		✳	✳			✳			✳	245
0-9733 M GUM	PYRA M GUM		✳										245
0-9900	OPERA	■	✳	✳	□	□			□				227
0-9900 M	OPERA M		✳										227
0-9940	SOUL	□	□	□									225
0-9942 R	SOUL R	□	□	□									225

Piktogrammzuordnung / Pictogram allocation

LASER hochglanz/silver gloss	LASER gold	LASER rotgold	LASER silber / silver	LASER weiß / white	LASER beige / beige	LASER grau / grey	LASER schwarz glänzend/black gloss
✳	■	■	□	□	■	■	■

Artikel-Nr. Item No.	Modell Model	Werbeschlüssel Advertising code			Seite Page	Artikel-Nr. Item No.	Modell Model	Werbeschlüssel Advertising code			Seite Page
		Schaft Barrel	Clip Clip	Kappe Cap				Schaft Barrel	Clip Clip	Kappe Cap	
0-0011	FANTASY	S ○	T		166	0-0063 KT-SI GUM	ON TOP K transparent SI GUM	GS	T/HD/RD		191
0-0011 T	FANTASY transparent	S ○	T		166	0-0063 RECY	ON TOP RECY	S	T/HD/RD		71
0-0012 SI	ENERGY SI	S ○	MT/L		167	0-0063 SI	ON TOP SI	S	T/HD/RD		190
0-0012 TF-SI	ENERGY frozen SI	S ○	MT/L		167	0-0063 SI F	ON TOP SI F	S	T/HD/RD		190
0-0013 TF	SUNNY frozen	S ○	T		166	0-0063 SI GUM	ON TOP SI GUM	GS	T/HD/RD		191
0-0017	PIXEL	S ○	T		203	0-0063 T-SI	ON TOP transparent SI	S	T/HD/RD		191
0-0017 RECY	PIXEL RECY	S ○	T		76	0-0068 SI	BLOOM SI	S	T/HD/RD		187
0-0017 TF	PIXEL frozen	S ○	T		203	0-0071	POP	S	T/HD/RD T		195
0-0037	HAPPY	S ○	T		130	0-0071 RECY	POP RECY	S	T/HD/RD		75
0-0037 K-TF	HAPPY K frozen	S ○	T		131	0-0071 T	POP transparent	S	T/HD/RD T		195
0-0037 RECY	HAPPY RECY	S ○	T		69	0-0077	BEAT	S	T		135
0-0037 TF	HAPPY frozen	S ○	T		131	0-0077 T	BEAT transparent	S	T		135
0-0039	STRIPE	S	T		172	0-0086 F-SI	EFFECT F SI	S	S/HD/RD TT ^{Stopfen/ plug}		196
0-0040 SI	TWISTY SI	S	S		134	0-0086 SI	EFFECT SI	S	S/HD/RD TT ^{Stopfen/ plug}		196
0-0040 TF	TWISTY frozen	S	S		134	0-0086 TOP SI	EFFECT TOP SI	S	S/HD/RD TT ^{Stopfen/ plug}		197
0-0045	RINGO	S		T	205	0-0086 TOP T-SI	EFFECT TOP transparent SI	S	S/HD/RD TT ^{Stopfen/ plug}		197
0-0045 SI	RINGO SI	S		T	205	0-0087	PRIMA	S	T		137
0-0046	KLICK	S	T		175	0-0090	X-DREAM	S	T		136
0-0046 SI	KLICK SI	S	T		175	0-0090 CO-SM	X-DREAM CO SM	S	T		136
0-0053	QUANTUM	S		T	180	0-0092 F	YES F	S ○	T		127
0-0053 M	QUANTUM M	S		T	181	0-0092 F-SI	YES F SI	S ○	T		127
0-0053 MR	QUANTUM MR	T		T	181	0-0092 RECY	YES RECY	S ○	T		59
0-0053 R	QUANTUM R	T		T	180	0-0092 TF	YES frozen	S ○	T		126
0-0056 M-SI	ICON M SI	S	MT/L		200	0-0092 TF-SI	YES frozen SI	S ○	T		126
0-0056 M-SI GUM	ICON M SI GUM	GS	MT/L		201	0-0093	YES	S ○	T		129
0-0056 SI	ICON SI	S	T		200	0-0093 ANTIBAC	YES antibacterial	S ○	T		59
0-0057 GUM	ICONIC GUM	GS	GT		199	0-0093 LUX	YES LUX	S ○	T		129
0-0057 RECY	ICONIC RECY	S	T		73	0-0093 LUX SI	YES LUX SI	S ○	T		128
0-0063 F	ON TOP F	S ○	T/HD/RD		189	0-0093 SI	YES SI	S ○	T		128
0-0063 F RECY	ON TOP F RECY	S ○	T/HD/RD		70	0-0093 T	YES transparent	S ○	T		129

Artikel-Nr. Item No.	Modell Model	Werbeschlüssel Advertising code			Seite Page	Artikel-Nr. Item No.	Modell Model	Werbeschlüssel Advertising code			Seite Page
		Schaft Barrel	Clip Clip	Kappe Cap				Schaft Barrel	Clip Clip	Kappe Cap	
0-0093 T-SI	YES transparent SI	S ○	T		128	0-0133 SI	TRINITY SI	T/HD/RD	T/HD/RD		107
0-0096 SI	UP SI	S	S		133	0-0133 SI GUM	TRINITY SI GUM	GT/HD/RD	T/HD/RD		106
0-0096 T-SI	UP transparent SI	S	S		133	0-0133 SI RECY	TRINITY SI RECY	T/HD/RD	T/HD/RD		65
0-0112 SI	MEMORY SI	S ○	T		159	0-0133 T-SI	TRINITY transparent SI	T/HD/RD	T/HD/RD		107
0-0112 T-SI	MEMORY transparent SI	S ○	T		159	0-0134 KT-SI	FASHION K transparent SI	S ○	T		163
0-0122 M-SI	LOOK grip M SI	S	MT/L		173	0-0134 SI	FASHION SI	S ○	T		163
0-0122 SI	LOOK grip SI	S	T		172	0-0136 SI	VOGUE XL SI	S ○			165
0-0122 TM-SI	LOOK grip transparent M SI	S	MT/L		173	0-0146 SI	PUR SI	S	L		177
0-0122 T-SI	LOOK grip transparent SI	S	T		172	0-0146 T-SI	PUR transparent SI	S	L		177
0-0124 LUX M-SI	CANDY LUX M SI	S	L		171	0-0151	STREAM	T	T		121
0-0124 M-SI	CANDY M SI	S	L		171	0-0151 M-SI	STREAM M SI	T	MT/L		121
0-0124 SI	CANDY SI	S	T		169	0-0154 SI	LINEO SI	T	T		125
0-0124 TM-SI	CANDY transparent M SI	S	L		171	0-0154 TF-SI	LINEO frozen SI	T	T		125
0-0124 T-SI	CANDY transparent SI	S	T		169	0-0177	CORAL	S	T		119
0-0125	SKY	S	T		110	0-0177 GUM	CORAL GUM	GS	GT		117
0-0125 GUM	SKY GUM	GS	T		109	0-0177 SI	CORAL SI	S	T		119
0-0125 M	SKY M	S	MT/L		110	0-0177 TF	CORAL frozen	S	T		119
0-0125 M GUM	SKY M GUM	GS	MT/L		109	0-0177 TF-SI	CORAL frozen SI	S	T		119
0-0125 M-SI	SKY M SI	S	MT/L		110	0-0183 F	VANE F	S	T/HD/RD		193
0-0125 M-SI GUM	SKY M SI GUM	GS	MT/L		109	0-0183 RECY	VANE RECY	S	T/HD/RD		74
0-0125 TM	SKY transparent M	S	MT/L		111	0-0184 GUM	VANE GUM	GS	T/HD/RD		192
0-0125 TM-SI	SKY transparent M SI	S	MT/L		111	0-0184 KG GUM	VANE KG GUM	GS	T/HD/RD		192
0-0133	TRINITY	T/HD/RD	T/HD/RD		107	0-0185 SI GUM	VANE SI GUM	GS	T/HD/RD		193
0-0133 GUM	TRINITY GUM	GT/HD/RD	T/HD/RD		106	0-0196 L	RONDO chrom L	MS/L			256
0-0133 KG-SI GUM	TRINITY KG SI GUM	GT/HD/RD	T/HD/RD		106	0-0200	TEXTMARKER	P	P		276
0-0133 KT GUM	TRINITY K transparent GUM	GT/HD/RD	T/HD/RD		103	0-0200/2	TEXTMARKER 2er-SET	P	P		276
0-0133 KT RECY	TRINITY K transparent RECY	T/HD/RD	T/HD/RD		67	0-0200/3	TEXTMARKER SET	P	P	Box TT	277
0-0133 KT-SI GUM	TRINITY K transparent SI GUM	GT/HD/RD	T/HD/RD		103	0-0200/3 SI	TEXTMARKER SET SI	P	P	Box TT	277
0-0133 KT-SI RECY	TRINITY K transparent SI RECY	T/HD/RD	T/HD/RD		67	0-0240	LIQEO HIGHLIGHTER	P	P		273
0-0133 RECY	TRINITY RECY	T/HD/RD	T/HD/RD		65	0-0240/2 P	PAPPFALTSCHACHEL Verpackung	TT	auf Etui/on case		273

Artikel-Nr. Item No.	Modell Model	Werbeschlüssel Advertising code			Seite Page	Artikel-Nr. Item No.	Modell Model	Werbeschlüssel Advertising code			Seite Page
		Schaft Barrel	Clip Clip	Kappe Cap				Schaft Barrel	Clip Clip	Kappe Cap	
0-0240/3 P	PAPPFALTSCHACHTEL Verpackung	TT auf Etui/on case			273	0-0945/4	SET BOX	TT			280
0-0240/4	LIQEO HIGHLIGHTER 4er SET	TT/HD auf Etui/on case			273	0-0946 CI	KISSENVERPACKUNG/ PILLOW PACK		individuell/ individual		281
0-0250	LIQEO HIGHLIGHTER MINI	P	P		274	0-0955 rPET	ETUI rPET	HD			284
0-0250/4	LIQEO HIGHLIGHTER MINI 4er SET	TT/HD auf Etui/on case			274	0-0962 M	METALLETUI M	TT/L			289
0-0270	LIQEO HIGHLIGHTER PEN	P	P		275	0-0962 ML	METALLETUI ML	TT/L			289
0-0270/4	LIQEO HIGHLIGHTER PEN 4er SET	TT/HD auf Etui/on case			275	0-2210 F	RECYCLED PET PEN STEP F	S	T		33
0-0506 KE	DESK KE	TT/HD auf Werbeplatte/on panel			282	0-2210 F GUM	RECYCLED PET PEN STEP F GUM	GS	T		32
0-0506 LUX-KE	DESK LUX KE	TT/HD auf Werbeplatte/on panel			282	0-2210 TF	RECYCLED PET PEN STEP frozen	S	T		33
0-0531	OMEGA grip	S	O	T	157	0-2217 F	RECYCLED PET PEN FUTURE F	S	T/HD/RD		29
0-0531 T	OMEGA grip transparent	S	O	T	157	0-2217 F GUM	RECYCLED PET PEN FUTURE F	GS	T/HD/RD		31
0-0580	JAZZ	S			178	0-2217 TF	RECYCLED PET PEN FUTURE frozen	S	T/HD/RD		29
0-0580 TF	JAZZ frozen	S			178	0-2225	RECYCLED PET BOX	TT auf Box/on box			283
0-0900 LE	LEDERETUI	TT			289	0-2240	RECYCLED PET PEN switch	S	T		58
0-0901	QUATER	TT			282	0-2240 T	RECYCLED PET PEN switch transparent	S	T		58
0-0909 P	TUBE	TT		TT	282	0-2248	RECYCLED PET PEN CHANGE	S	T/HD/RD		26
0-0913	ETUI	TT/HD/RD			288	0-2248 OCEAN	RECYCLED PET PEN CHANGE ocean	S	T/HD/RD		27
0-0914	ETUI	TT			286	0-2248 T	RECYCLED PET PEN CHANGE transparent	S	T/HD/RD		26
0-0914 CI	ETUI CI		individuell/ individual		286	0-2250	RECYCLED PET PEN PRO	S	T		36
0-0914/2	ETUI	TT			286	0-2250 ANTIBAC	RECYCLED PET PEN PRO antibacterial	S	T		51
0-0914/2 CI	ETUI CI		individuell/ individual		286	0-2250 F	RECYCLED PET PEN PRO F	S	T		36
0-0917	ETUI	TT			288	0-2250 F OCEAN	RECYCLED PET PEN PRO F ocean	S	T		49
0-0918	CASE	TT/HD /RD			287	0-2250 F-SI	RECYCLED PET PEN PRO F SI	S	T		45
0-0933 CI	DREIECKSVERRACKUNG/ TRIANGULARETUI		individuell/ individual		281	0-2250 F-SI GUM	RECYCLED PET PEN PRO F SI GUM	GS	T		47
0-0940	PAPPSTECKETUI	TT			285	0-2250 F TO	RECYCLED PET PEN PRO F TOUCH	S	T		53
0-0940 CI	PAPPSTECKETUI CI		individuell/ individual		285	0-2250 KT GUM	RECYCLED PET PEN PRO K transparent GUM	GS	T		35
0-0940 RECY	PAPPSTECKETUI RECY	TT			285	0-2250 T	RECYCLED PET PEN PRO transparent	S	T		37
0-0942	PAPPSTECKETUI	TT			284	0-2250 TF	RECYCLED PET PEN PRO frozen	S	T		37
0-0943	SQUARE	TT			280	0-2250 TF-SI	RECYCLED PET PEN PRO frozen SI	S	T		45
0-0944	BOX	TT/HD/RD			287	0-2252 R	RECYCLED PET PEN PRO R	S	T	T	42
0-0945/3	SET BOX	TT			280	0-2254 FL	RECYCLED PET PEN PRO FL	S	T	T	42

Artikel-Nr. Item No.	Modell Model	Werbeschlüssel Advertising code			Seite Page	Artikel-Nr. Item No.	Modell Model	Werbeschlüssel Advertising code			Seite Page
		Schaft Barrel	Clip Clip	Kappe Cap				Schaft Barrel	Clip Clip	Kappe Cap	
0-2255	RECYCLED PET PEN PRO LIQEO	S	T	T	43	0-8940 C	GALILEO C	MS		MT/L	222
0-2260	RECYCLED PET PEN	S	T	TT Stopfen/plug	56	0-9100	VIP	MS/L/RL L		MT/L	217
0-2260 T	RECYCLED PET PEN transparent	S	T	TT Stopfen/plug	57	0-9100 GO	VIP GO	MS/L/RL L		MT/L	217
0-2260 T SG	RECYCLED PET PEN transparent SG	S	T	TT Stopfen/plug	56	0-9100 GUM	VIP GUM	GT/L		GT/L	216
0-2622	2in1	MS/L	L		267	0-9102 R	VIP R	MT/L/RL L		MT/L	217
0-2622 SET	2in1 SET	MS/L Schreib- gerät/Pen	L		267	0-9102 R GUM	VIP R GUM	GT/L		GT/L	216
0-6100	VIPOLINO	MS/L/RL L		MT/L	215	0-9106 F	VIP F	MT/L/RL L		MT/L	217
0-7200	RECYCLED PET PEN ALUMA	MS/MT/L	MT/L		55	0-9107 B	VIP B	MS/L/RL L		MT/L	217
0-7200 T	RECYCLED PET PEN ALUMA transparent	MS/MT/L	MT/L		55	0-9190	ELEGANCE	MS/L	L Stopfen/plug		221
0-8240	SUPREME	MS/L			259	0-9190 C	ELEGANCE C	MS	L Stopfen/plug		220
0-8242 R	SUPREME R	MT/L		MT/L	259	0-9190 GO	ELEGANCE GO	MS/L	L Stopfen/plug		221
0-8250	SLIMLINE	MS/L/RL L			261	0-9190 LUX	ELEGANCE LUX	L	L Stopfen/plug		220
0-8250 DOM	SLIMLINE DOM	MS/L/RL L	D	Stopfen/plug	261	0-9190 M	ELEGANCE M	MS/L	L Stopfen/plug		221
0-8320	SHADOW	MS/L	L	MT/L	263	0-9190 WOOD	ELEGANCE WOOD	MS/L	L Stopfen/plug		91
0-8322 R	SHADOW R	MT/L	L	MT/L	263	0-9340 C	MOOD C	MT		MT/L	211
0-8330	SIX	MT/L	L		252	0-9340 GUM	MOOD GUM	GT/L		GT/L	210
0-8340	SLIDE	MS/L	L	MT/L	265	0-9342 R C	MOOD R C	MT		MT/L	211
0-8340 TO	SLIDE TOUCH	MS/L	L	MT/L	265	0-9342 R GUM	MOOD R GUM	GT/L		GT/L	210
0-8342 R	SLIDE R	MT/L	L	MT/L	265	0-9350	MESH			L	213
0-8350	SMOKE	MS/L			253	0-9352 R	MESH R			L	213
0-8370	ETERNITY	MT/L		MT/L	223	0-9360	TITAN ONE	Mt/L		MT/L	219
0-8370 M	ETERNITY M	MT/L		MT/L	223	0-9360 M	TITAN ONE M	MT/L		MT/L	218
0-8372 MR	ETERNITY MR	MT/L		MT/L	223	0-9362 MR	TITAN ONE MR	MT/L		MT/L	218
0-8372 R	ETERNITY R	MT/L		MT/L	223	0-9362 R	TITAN ONE R	MT/L		MT/L	219
0-8600	ARCTIS	S	L		179	0-9370	TITAN WOOD	MT/L		L	89
0-8600 GO	ARCTIS GO	S	L		179	0-9372 R	TITAN WOOD R	MT/L		L	89
0-8607 B	ARCTIS B	S	L		179	0-9412	TAROT	MS/L			255
0-8800 M	CLASSICO M	MS/L		MT/L	226	0-9415	LUCKY	MS/L			257
0-8900	NOBILIS	MS			222	0-9438	COMMA	MS/L			257
0-8907 B	NOBILIS B	MS			222	0-9440	COSMOS	MS/L	L		256

Artikel-Nr. Item No.	Modell Model	Werbeschlüssel Advertising code			Seite Page	Artikel-Nr. Item No.	Modell Model	Werbeschlüssel Advertising code			Seite Page
		Schaft Barrel	Clip Clip	Kappe Cap				Schaft Barrel	Clip Clip	Kappe Cap	
0-9450	STRAIGHT	MS/L/RL	L		241	0-9610 GUM	BRUSH GUM	GS/L		GT/L L/D Stopfen/plug	233
0-9450 GO	STRAIGHT GO	MS/L/RL	L		243	0-9612 R GUM	BRUSH R GUM	GT/L		GT/L L/D Stopfen/plug	233
0-9450 GUM	STRAIGHT GUM	GS/L/RL	L		240	0-9630 F GUM	BRIGHT F GUM	GS/L	L	GT/L	235
0-9450 GUM RECY	STRAIGHT GUM RECY	GS/L/RL	L		95	0-9630 GUM	BRIGHT GUM	GS/L	L	L	235
0-9450 M GUM	STRAIGHT M GUM	GS/L/RL	L		240	0-9733	PYRA	MT/L			245
0-9450 M GUM RECY	STRAIGHT M GUM RECY	GS/L/RL	L		95	0-9733 GUM	PYRA GUM	GT/L			245
0-9450 RO-GO	STRAIGHT RO GO	MS/L/RL	L		243	0-9733 M GUM	PYRA M GUM	GT/L			245
0-9450 RO-GO GUM	STRAIGHT RO GO GUM	GS/L/RL	L		243	0-9900	OPERA	MS/L/RL			227
0-9450 SI	STRAIGHT SI	MS/L/RL	L		239	0-9900 M	OPERA M	MS/L/RL			227
0-9450 SI GUM	STRAIGHT SI GUM	GS/L/RL	L		239	0-9940	SOUL	MS/L		MT/L	225
0-9450 SI TO	STRAIGHT SI TOUCH	MS/L	L	MT/L	238	0-9942 R	SOUL R	MT/L		MT/L	225
0-9452 SI R TO	STRAIGHT SIR TOUCH	MT/L	L	MT/L	238	1-0041 RECY	CETA RECY	S ○	T		79
0-9457 B	STRAIGHT B	MS/L/RL	L		241	1-0041 SI	CETA SI	S ○	T		151
0-9457 GUM B	STRAIGHT GUM B	GS/L/RL	L		240	1-0041 TF-SI	CETA frozen SI	S ○	T		151
0-9457 SI B	STRAIGHT SI B	MS/L/RL	L		239	1-0043 C RECY	CHILL C RECY	S ○	MT/L	T	77
0-9460	VENUS	MS/L	L		254	1-0043 C-SI	CHILL C SI	S ○	MT/L	T	145
0-9470	MOON	MS/L	L		254	1-0043 C-SI RECY	CHILL C SI RECY	S ○	MT/L	T	77
0-9480 L	ARGUS L	MS/L	L		255	1-0043 CT-SI	CHILL C transparent SI	S ○	MT/L	T	145
0-9530 RECY	GROOVE RECY	MS/L			99	1-0043 SI	CHILL SI	S ○	MT/L	T	145
0-9530 M RECY	GROOVE M RECY	MS/L			99	1-0043 T-SI	CHILL transparent SI	S ○	MT/L	T	145
0-9530 TO RECY	GROOVE TOUCH RECY	MS/L			99	1-0044 SI	SPOT SI	S ○	T		149
0-9540 GUM	ELLIPSE GUM	GT/L			237	1-0044 T-SI	SPOT transparent SI	S ○	T		149
0-9540 SI	ELLIPSE SI	MT/L			236	1-0047 SI	ULTIMO SI	S ○	T		146
0-9560 GUM	LUMOS GUM	GS/L		GT/L	247	1-0047 T-SI	ULTIMO transparent SI	S ○	T		146
0-9560 M GUM	LUMOS M GUM	GS/L		GT/L	247	1-0048 SI	ULTIMATE SI	S ○	T/HD/RD		147
0-9560 RECY	LUMOS RECY	MS/L		MT/L	97	1-0048 SI RECY	ULTIMATE SI RECY	S ○	T/HD/RD		79
0-9560 STONE	LUMOS STONE	L		L	249	1-0048 TF-SI	ULTIMATE frozen SI	S ○	T/HD/RD		147
0-9575	PRIMUS	MS/L	L		251	1-0142 M-SI	CHECK M SI	S ○	L		142
0-9588 M TO	SKINNY M TOUCH	MS/L	L	MT/L	269	1-0142 SI	CHECK SI	S ○	T		143
0-9588 TO	SKINNY TOUCH	MS/L	L	MT/L	269	1-0142 TF KG SI	CHECK frozen KG SI	S ○	T		143

Artikel-Nr. Item No.	Modell Model	Werbeschlüssel Advertising code			Seite Page
		Schaft Barrel	Clip Clip	Kappe Cap	
1-0145 SI	PEPP SI	S ○	T/HD/RD		148
1-0145 T-SI	PEPP transparent SI	S ○	T/HD/RD		148
1-0147 SI	CRYS SI	S ○	T	T	153
1-0147 T-SI	CRYS transparent SI	S ○	T	T	153
1-0148 TF-SI	GEOS frozen SI	S ○	T	T	155
1-0149 SI	CHIC SI	S ○	MT/L		150
1-0149 TF-SI	CHIC frozen SI	S ○	MT/L		150
1-0690	TORSION	S ○			206
1-0735	VIANI	S ○	S		206
1-0736 RECY	VITAN RECY	S ○	T		61
5-5200	FOREST	MS/L/RL			87
5-5207 B	FOREST B	MS/L/RL			87
5-5400	TREE	MS/L/RL			85
5-5600	WOODY	MS/L/RL			86
5-5607 B	WOODY B	MS/L/RL			86
5-5700	ROOT	MS/L/RL L			83
5-5800	BEECH	MS/L/RL L			87
5-5900	LEAF	MS/L/RL			85
6-2250 H	PAPER PEN	S	MT		93
6-2860 G	FLEXI	S ○			207
6-2861 G	FLEXI M	S ○			207
6-3550	BIO PEN	S ○	T		93

○ Rundumdruck möglich

Gültig ab Januar 2025

Unsere Kataloge werden mit größter Sorgfalt zusammengestellt. Trotzdem kann die uma Schreibgeräte Ullmann GmbH für die Fehlerfreiheit und Genauigkeit der enthaltenen Informationen nicht garantieren.

Es gelten unsere allgemeinen Geschäftsbedingungen. Diese finden Sie unter www.uma-pen.com

○ All-around imprint

Valid from January 2025

Our catalogues are compiled with the greatest care. Nevertheless, uma Schreibgeräte Ullmann GmbH cannot guarantee the correctness and accuracy of the corresponding information.

You will find our latest terms and conditions of business at www.uma-pen.com





Die Handschrift der Werbung

