

YOUNG SYSTEM

22

YOUNG SYSTEM



YOU
NG
SYS
TEM

www.clei.it



SOMMARIO **YOUNG SYSTEM** INDEX

I PRIMI,
I SOLI ORIGINALI
THE FIRST,
THE REAL ORIGINAL
> P.4

IL NUOVO MODO
DI ABITARE
THE NEW WAY OF
LIVING
> P.6

LA CASA INTELLIGENTE
THE SMART HOUSE
> P.8

ONE MORE ROOM
VANTAGGI SENZA LIMITI
ADVANTAGES WITH NO LIMITS
> P.10

CLEI SYSTEM
TOTAL LOOK_DAY & NIGHT
> P.12

CLEI COLOUR SYSTEM:
TOTALE LIBERTÀ DI SCELTA
TOTAL FREEDOM OF CHOICE
> P.120



AMBIENTE 01
> P.14
KALI BOARD 120
KALI STANDARD 90
MIGUEL 60



AMBIENTE 02
> P.24
KALI BOARD 120
KALI SOFA 120



AMBIENTE 03
> P.32
KALI STANDARD 90
APP



AMBIENTE 04
> P.36
KALI SOFA 120
ALTEA BOOK 90 STANDARD - P.62,3
WALLY



AMBIENTE 05
> P.44
KALI DUO BOARD 2200
ALTEA BOOK 120 SOFA - P.62,3



KALI DUO SOFA 2200
> P.54



KALI DUO STANDARD 2200
> P.58



AMBIENTE 06
> P.62
KALI PONTE BOARD 2200
ALTEA 120 SOFA - P.35



AMBIENTE 07
> P.70
KALI PONTE STANDARD 2561
ALTEA 120 SOFA - P.35
GIRÒ



AMBIENTE 08
> P.80
ALTEA BOOK 120 WORK - P.62,3
KALI SOFA 120



AMBIENTE 09
> P.90
ALTEA BOOK 120 BOARD - P.62,3
ALTEA BOOK 120 SOFA - P.62,3
GIRÒ



AMBIENTE 10
> P.100
CABRIO IN
KALI PONTE SOFA 2561



AMBIENTE 11
> P.108
CABRIO IN
ALTEA 120 SOFA - P.35



WALLY
> P.118



**SCHEDE TECNICHE
TECHNICAL FILES**
> P.122



**TIPOLOGIA MODELLI
AVAILABLE SYSTEMS**
> P.143



**INDICE ANALITICO
ANALYTICAL INDEX**
> P.154



S K R I O G H M U S V F A C Z D P W M O
U S V F A C Z D P W M K G R I F O S H M
C Z D P W O S K R I O G H M U S V F F A
S C O N C L E I K R I O G H F A C M U
W S I P U O ' . . F A C Z M U S D P
I O G H M U S V F Z D K W O S D P W K R
O M O L T I P L I C A R E V F A C Z R I
R I L V A L O R E A Z Z M C G R I W K
V D E L L O K Z D P W I S O R H M U S S
D S P A Z I O V E X P E R I E N C E F Z
O G M U S V F M F A A F G G A A C Z R I
H M U S V F D D P A S M E W T H R I O G
O G H F A C K G R N S I G U I V I O R I
A C K D P W D D D V I R S S V S K R V F
W I N S P I R A T I O N O Z I F S V D P
H O O M U S S S F K N K V S T K Z D O G
S K W I O C L E I F M A M O Y O S V A C
F A - Z F M A K E S I T R C V F M P V
R V H A C P O S S I B L E . . D D O S
I D O W O M U L T I P L Y I N G F F V F
F K W Z O T H E U G W U S V U S S S M U
P G Z A C V A L U E O G H V F A C Z R I
R I M U S O F S V F A C Z M K G R I W K
F F D P W S P A C E W O S O G H M U S S
D P R I F O S V F A C Z D G F A C Z F Z

DAL
SINCE
19
63

I PRIMI,
I SOLI ORIGINALI
THE FIRST,
THE REAL ORIGINAL

Le aziende sono come le persone: nessuna è mai uguale ad un'altra. Tuttavia, per quel che riguarda il mondo delle aziende, qualcuna è assolutamente diversa da tutte le altre. È il nostro caso. [È stata Clei la prima azienda](#) - a partire dal lontano 1963 - ad esplorare il complesso mondo del mobile trasformabile, diventando nel tempo specialista indiscussa dell'habitat multifunzionale. Come sempre accade agli innovatori, [Clei è stata costantemente imitata](#). Un dato di fatto che ci ha sempre motivati a sostenere con passione la ricerca e l'innovazione per creare valore di cui siamo orgogliosi. Il valore distintivo della forte propensione al nuovo e dei prodotti con tecnologie brevettate con lo sguardo sempre rivolto al futuro.

Companies are like people: none is ever like another. However, as far as the corporate world is concerned, some are completely different from them all. This was true of us. [Clei has been the first company](#) - since 1963 - to explore the complex world of transformable furniture, becoming during time an undisputed specialist of the multifunctional living. As always happens to innovators, [Clei is constantly imitated](#). A reason that has always motivated us to support with passion research and innovation to create value we are proud of. The distinctive value of a strong inclination towards new developments and of products with patented technologies, always with an eye to the future.



IL NUOVO MODO DI ABITARE

LA CASA INTELLIGENTE SECONDO CLEI

THE NEW WAY OF LIVING

THE SMART HOUSE BY CLEI

L'urbanizzazione rappresenta uno dei fenomeni più importanti della nostra epoca: recenti stime indicano che più della metà degli abitanti della Terra vive oggi in città. Un fenomeno impressionante da ogni punto di vista, se pensiamo che all'inizio dell'Ottocento gli abitanti delle città erano solo il 5% della popolazione. Per rispondere alla sfida della crescita esponenziale delle città la tecnologia più avanzata è scesa in campo con applicazioni sempre più sofisticate basate sull'interpretazione dei "Big Data". In tal modo grazie all'interconnessione delle reti digitali la città diventa **SMART CITY** e impara a gestire in modo intelligente il tempo, lo spazio e le risorse.

Una vera e propria rivoluzione la cui onda lunga ha toccato anche il modo e i modi dell'abitare. La "casa dell'uomo", un concetto fermo alle sperimentazioni dei grandi urbanisti europei del secolo scorso, sta subendo una trasformazione evolutiva di eccezionale portata.

L'idea di casa cambia in virtù di una diversa e più intelligente progettazione degli elementi abitativi che la rendono tale; una concezione dell'arredo basata su una radicale quanto innovativa re-interpretazione della funzione d'uso, ha rivoluzionato le tradizionali suddivisioni degli spazi domestici rendendo del tutto obsolete le classiche suddivisioni legate alla pura dimensione temporale. Il mobile intelligente, risultato di un progetto di ricerca che coniuga tecnologia e design, archivia le definizioni "giorno" e "notte" e rende definitivamente superata anche la categoria delle così dette "camerette". La metamorfosi resa possibile dall'innovazione intelligente trionfa infine sulla staticità e sulla tradizione.

Urbanization is one of the most important aspects of our time: recent evaluations say that more than half of the people on Earth lives today in a city. This is an amazing phenomenon, under every point of view, if we think that at the beginning of the XIX century the inhabitants of cities were only 5% of the whole population. In reply to the challenge of the exponential growing of cities, the most advanced technology came into action with even more sophisticated applications, based on the interpretation of the "Big Data". As a result, thanks to the interconnection of the digital networks, the city becomes **SMART CITY** and learns how to organize time, space and resources in an intelligent way.

A real revolution, whose long wave has involved also the way of living. The "house of the human", a concept that has stopped at the trials of big European urbanists of the last century, is getting an exceptionally great evolutionary transformation.

The idea of "house" changes upon a different and more intelligent design of the living features that make it what it is; a concept of the furnishing, based on a radical as well as innovative re-interpretation of the final use, has deeply changed the traditional repartition of house areas, making the classic time-connected divisions totally old. The smart furniture, result of a research project that joins technology and design, stores the definition of "day" and "night" and makes definitely outdated also the so-called "kid's bedrooms" category. The metamorphosis that has been possible thanks to clever innovation and that wins on static nature and tradition.



LA CASA INTELLIGENTE THE SMART HOUSE

RICERCA/GENIALITÀ/DESIGN/INNOVAZIONE/
TECNOLOGIA BREVETTATA

RESEARCH/INTELLIGENCE/DESIGN/
INNOVATION/PATENTED TECHNOLOGY



FLESSIBILITÀ, INTERAZIONE
E OTTIMIZZAZIONE DELLO SPAZIO
FLEXIBILITY, INTERACTION
AND SPACE OPTIMISATION

Spazi che si amplificano, si moltiplicano, si compongono e si nascondono. Così l'arredo diventa dinamico e interattivo grazie alla multifunzionalità di prodotti di design, che possono assumere diverse configurazioni finalizzate per diversi utilizzi.

Prodotti che racchiudono ricerca, creatività, innovazione, ingegnerizzazione, capaci di massimizzare le dimensioni dello spazio e di rispondere alle specifiche esigenze per stili di vita e budget di spesa.

Spaces that are amplified, multiplied, combined and concealed. Interior design becomes dynamic and interactive thanks to the multi-functionality of design products, which can be configured in different ways for various uses.

Products that involve research, creativity, innovation and engineering, which can maximise the size of a space and meet specific lifestyle and budget requirements.

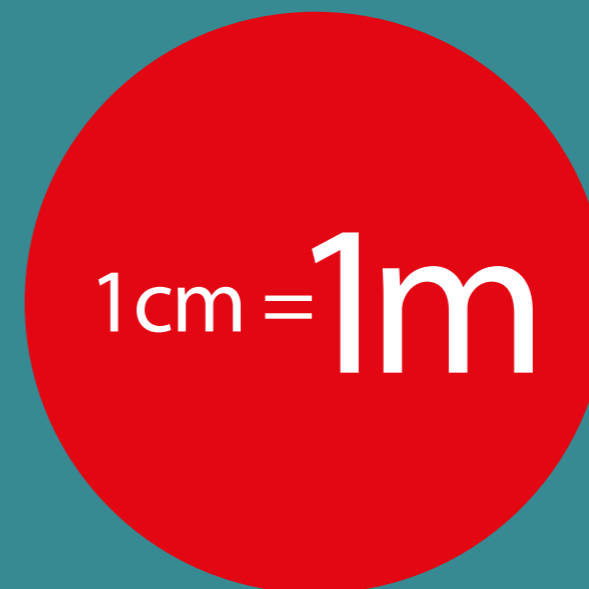

PRATICAMENTE...
UNA STANZA IN PIÙ
PRACTICALLY...
ONE MORE ROOM

ONE MORE ROOM

VANTAGGI SENZA LIMITI
ADVANTAGES WITH NO LIMITS

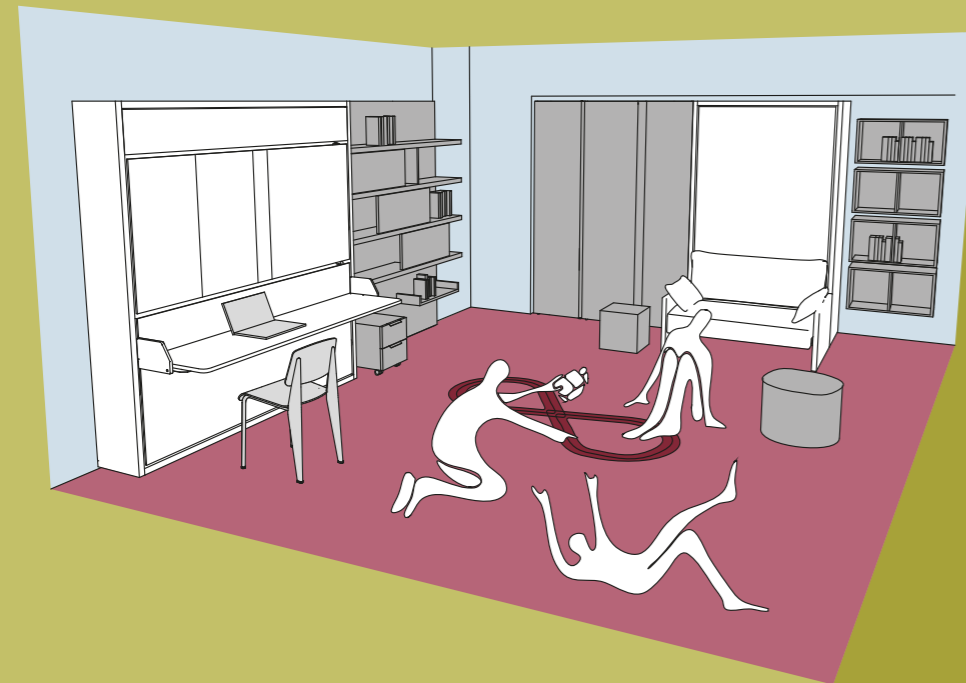

PLAYING

CLEI MOLTIPLICA
LO SPAZIO
E SOPRATTUTTO
IL VALORE DELLO SPAZIO

Living & Young System.
Il programma componibile è stato progettato per integrare sistemi trasformabili brevettati e per specifiche funzioni. La versatilità dei prodotti, ad elevato contenuto tecnologico, che con semplici gesti si trasformano nelle versioni giorno, notte e spazio ragazzi, consente di progettare soluzioni di arredo polifunzionali, rispondendo in modo dinamico alle molteplici e diverse esigenze abitative. Design e tecnologia per più funzioni e soluzioni, significano un habitat multifunzionale, senza vincoli e compromessi. Librerie, contenitori, divani, tavoli, scrittoi, si coniugano in spazi divisi e condivisi, e si trasformano da mobili giorno in versione notte con comodi letti sempre pronti, determinando così molteplici vantaggi rispetto all'arredamento tradizionale.

CLEI MULTIPLIES
SPACE
AND ESPECIALLY
THE VALUE OF SPACE

Living & Young System.
The modular program was designed to integrate patented transformable systems and for specific functions. The versatility of the high-tech products, which simply transform into daytime, night-time and children's room versions, allow you to design multi-functional furnishing solutions, dynamically responding to many different housing needs. Design and technology for more functions and solutions, mean a multi-functional habitat without constraints and compromises. Bookcases, containers, sofas, tables and desks combine in divided and shared spaces, and transform from daytime to night-time versions with comfortable beds that are always ready for use, thus offering many advantages over traditional furniture.

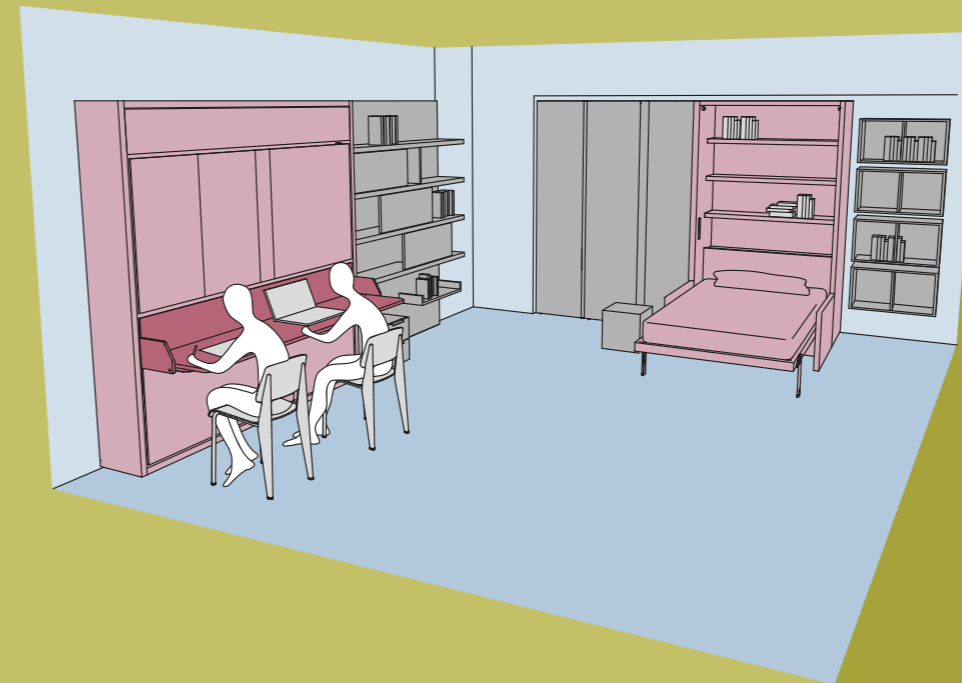

STUDYING^{NOW}
WORKING^{IN THE FUTURE}



RELAXING

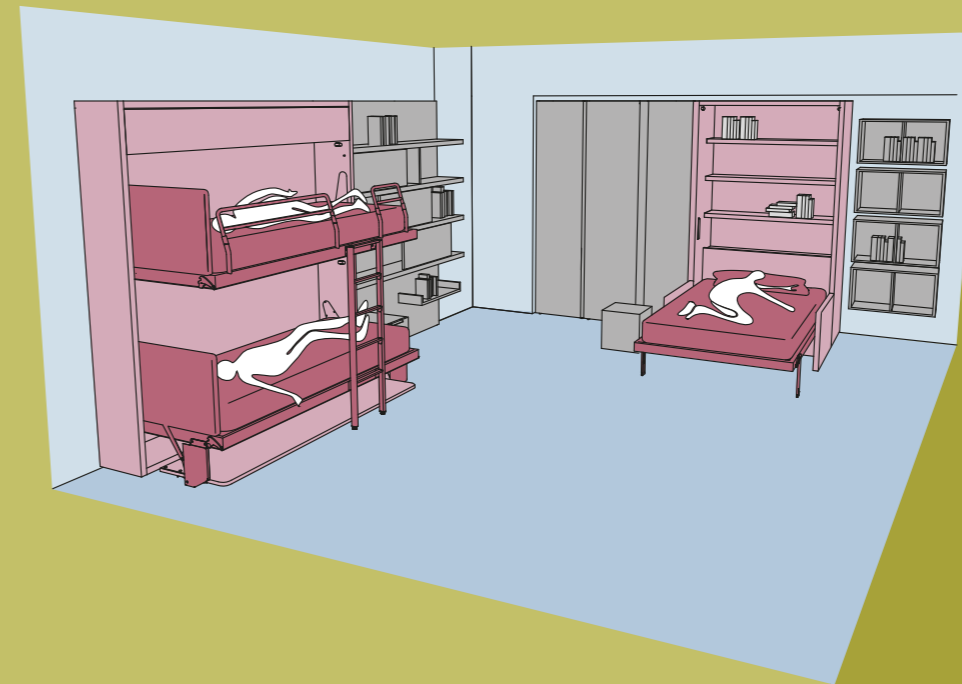

SLEEPING
2+1

CLEI SYSTEM

_TOTAL LOOK DAY & NIGHT

YOUNG SYSTEM

Non si smette mai di crescere. Ma se gli abiti sono diventati improvvisamente stretti, alla camera attrezzata con mobili Clei questo non accadrà. Cambia l'età e con essa le esigenze, i desideri e le aspirazioni.

Ed ecco che, come per magia, la camera dei ragazzi diventa contemporaneamente il luogo dove si gioca, si studia, si sta con gli amici e, finalmente, si dorme.

We never stop growing, and clothes can become too tight - but this never happens to a room furnished with Clei. Our needs, desires and ambitions change as we grow. And as if by magic the kids' room becomes a place where they can play, study, welcome friends and eventually sleep.

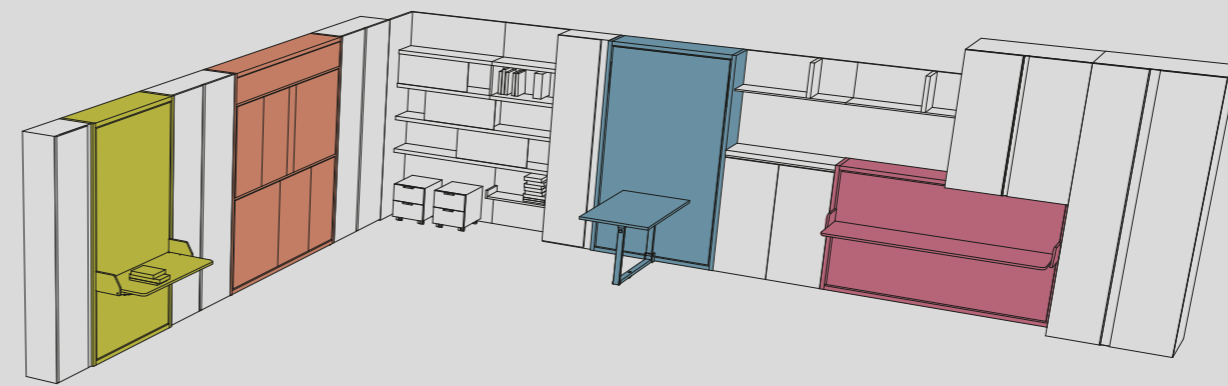
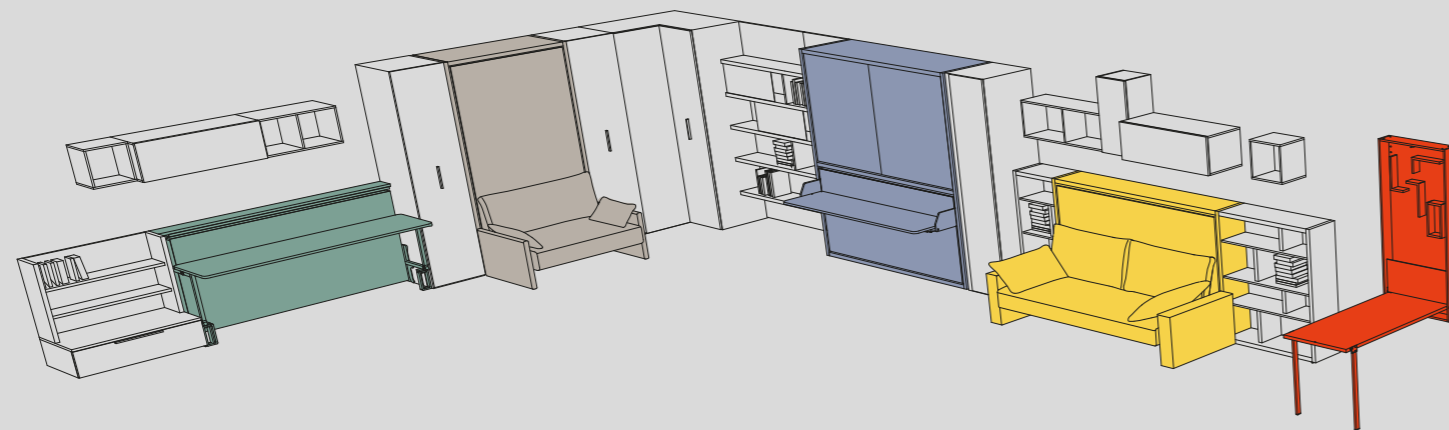

DAY

NIGHT

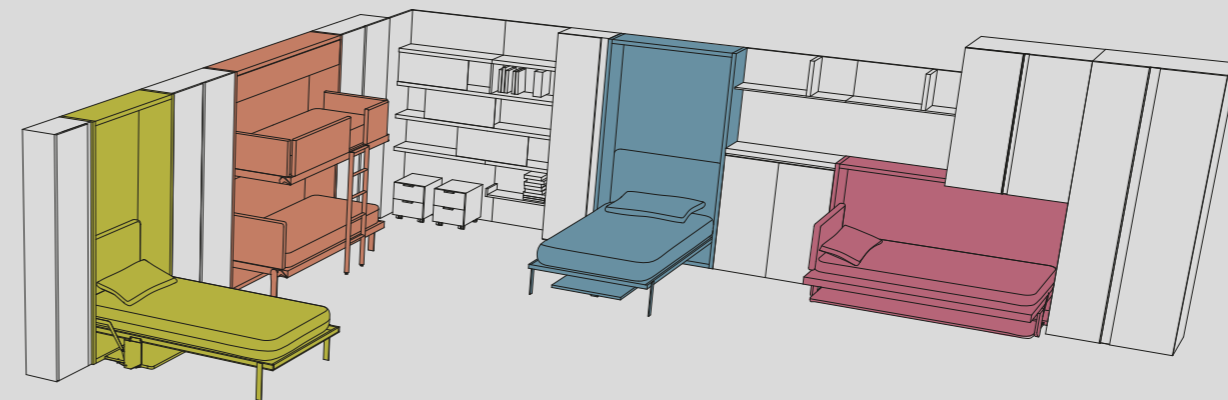
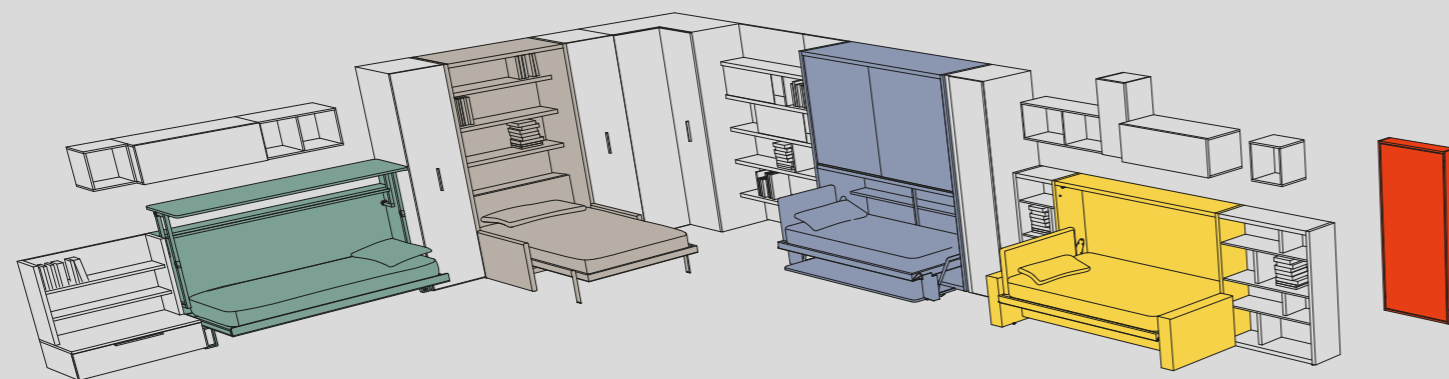

Ambiente 01

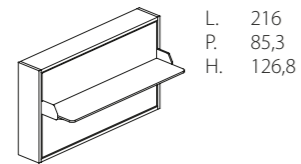
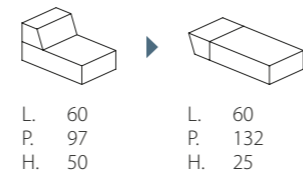
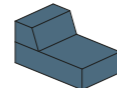
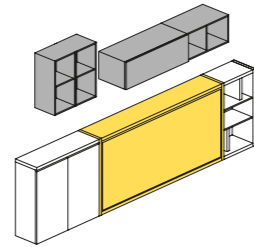
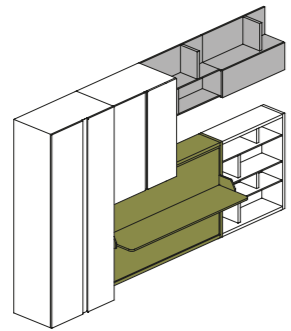

L. 216
P. 85,3
H. 126,8

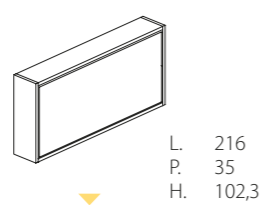

L. 216
P. 35
H. 102,3

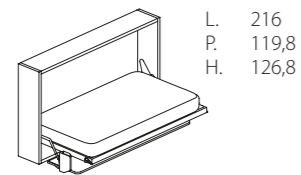

L. 216
P. 119,8
H. 126,8

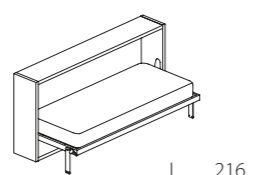

L. 216
P. 95,2
H. 102,3

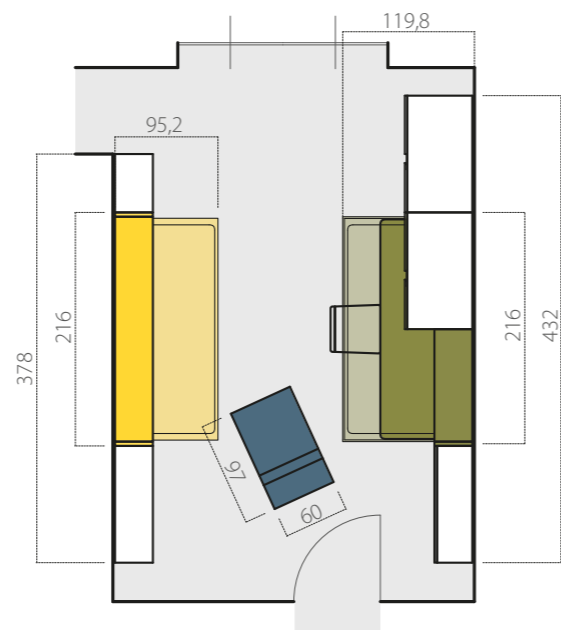

- KALI BOARD 120
- KALI STANDARD 90
- MIGUEL 60
- TETRIS
- LIVING & YOUNG SYSTEM

KALI BOARD 120

Rete CF09.
protetta da brevetto
patent protected

Board.
protetto da brevetto
patent protected

KALI STANDARD 90

Rete CF09.
protetta da brevetto
patent protected

Nelle immagini:
il sistema Kali nelle versioni
Standard e Board, integrato
nei programmi Living & Young
System con elementi Tetris
libreria e pensili e contenitori/
ponte con anta a gola.

Pictured:
Kali System in Standard and
Board versions, integrated
in the Living & Young
System programs, with Tetris
bookshelf elements and wall
units and cabinets/bridge with
handleless door.







KALI BOARD 120

Sistema trasformabile Kali con letto singolo (90 cm) o intermedio (120 cm) a scomparsa, con rete a doghe brevettata CF09, testata tessile reclinabile e scrittoio maxi brevettato. Sistema con apertura abbattibile e dotato del dispositivo di sicurezza che impedisce aperture e chiusure accidentali.

Meccanismo di articolazione con molle a gas e dispositivo di movimento ammortizzato, totalmente incassato nel fianco del mobile mediante tecnologia brevettata e speciale lavorazione.

Il sistema trasformabile con un semplice movimento si trasforma nella versione notte senza rimuovere nulla dal grande piano scrittoio che bascula e si posiziona orizzontalmente sotto al letto.

Il sistema trasformabile Kali si articola nelle versioni Standard (con letto orizzontale singolo 90 cm e intermedio 120 cm), Board (letto singolo o intermedio, con scrittoio), Sofa (letto singolo o intermedio, con divano).

Kali transforming system features a tilting single (90 cm) or intermediate (120 cm) bed, with patented CF09 slatted bed base, a reclining fabric headboard and a patented large desk. The tilting opening system is fitted with a safety device preventing accidental opening and closing.

Tilting mechanism through gas springs and device that cushions movements, completely contained in the side of the structure, thanks to patented technology and special manufacturing.

The system transforms into the night-time position in one simple movement, without the user having to remove anything from the desk which pivots and slots in horizontally underneath the bed.

Kali transforming system is available in the Standard (horizontal 90 cm single or 120 cm intermediate bed), Board (single or intermediate bed, with desk) and Sofa (single or intermediate bed, with sofa) versions.

Scrittoio/Desk
cm L 203,1 x P 50,3 x H 72
Mobile Letto chiuso/Plain System with closed bed
cm L 216 x P 35 x H 126,8

Mobile Letto chiuso + Scrittoio/
Plain System with closed bed + Desk
cm L 216 x P 85,3 x H 126,8

—
Mobile Letto aperto/System with open bed
cm L 216 x P 119,8 x H 126,8

LETTO +
SCRITTOIO +
= KALI BOARD







KALI STANDARD 90

Sistema trasformabile Kali in versione Standard: letto orizzontale singolo (90 cm) o intermedio (120 cm) con rete a doghe brevettata CF09 e testata tessile reclinabile, con apertura abbattibile e dotato del dispositivo di sicurezza che impedisce aperture e chiusure accidentali. Meccanismo di articolazione con molle a gas e dispositivo di movimento ammortizzato, totalmente incassato nel fianco del mobile mediante tecnologia brevettata e speciale lavorazione.

Kali transforming system in the Standard version: horizontal single (90 cm) or intermediate bed (120 cm) with patented CF09 slatted bed base and reclining fabric headboard, features a fold-down opening mechanism and safety device that prevents accidental opening and closing. Tilting mechanism with gas springs and device that cushions movements, completely contained in the side of the structure, thanks to patented technology and special manufacturing.

Mobile Letto chiuso/
System with closed bed
cm L 216 x P 35 x H 102,3

Mobile Letto aperto/
System with open bed
cm L 216 x P 95,2 x H 102,3

**LETTO
A SCOMPARSA**

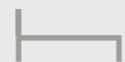

**KALI
STANDARD**

MIGUEL 60

Chaise longue nelle larghezze 60 cm e 84 cm, con schienale ribaltabile, imbottitura in gomma e rivestimento in tessuto sfoderabile. Lo schienale ribaltabile si allinea alla seduta e la chaise longue può essere riposta sotto al letto dei sistemi trasformabili Kali e Altea, solo nelle versioni Standard e nei modelli Penelope Standard e Board.

Chaise longue in width 60 and 84 cm with fold-down backrest, foam padding and removable fabric cover. The backrest can be folded down to align with the seat and the chaise longue can be stowed under the bed in the Kali and Altea transformable systems, only in the Standard versions and Penelope Standard and Board versions.

Chiuso/Closed
cm L 60 x P 97 x H 50

—
Aperto/Open
cm L 60 x P 132 x H 25



Ambiente 02

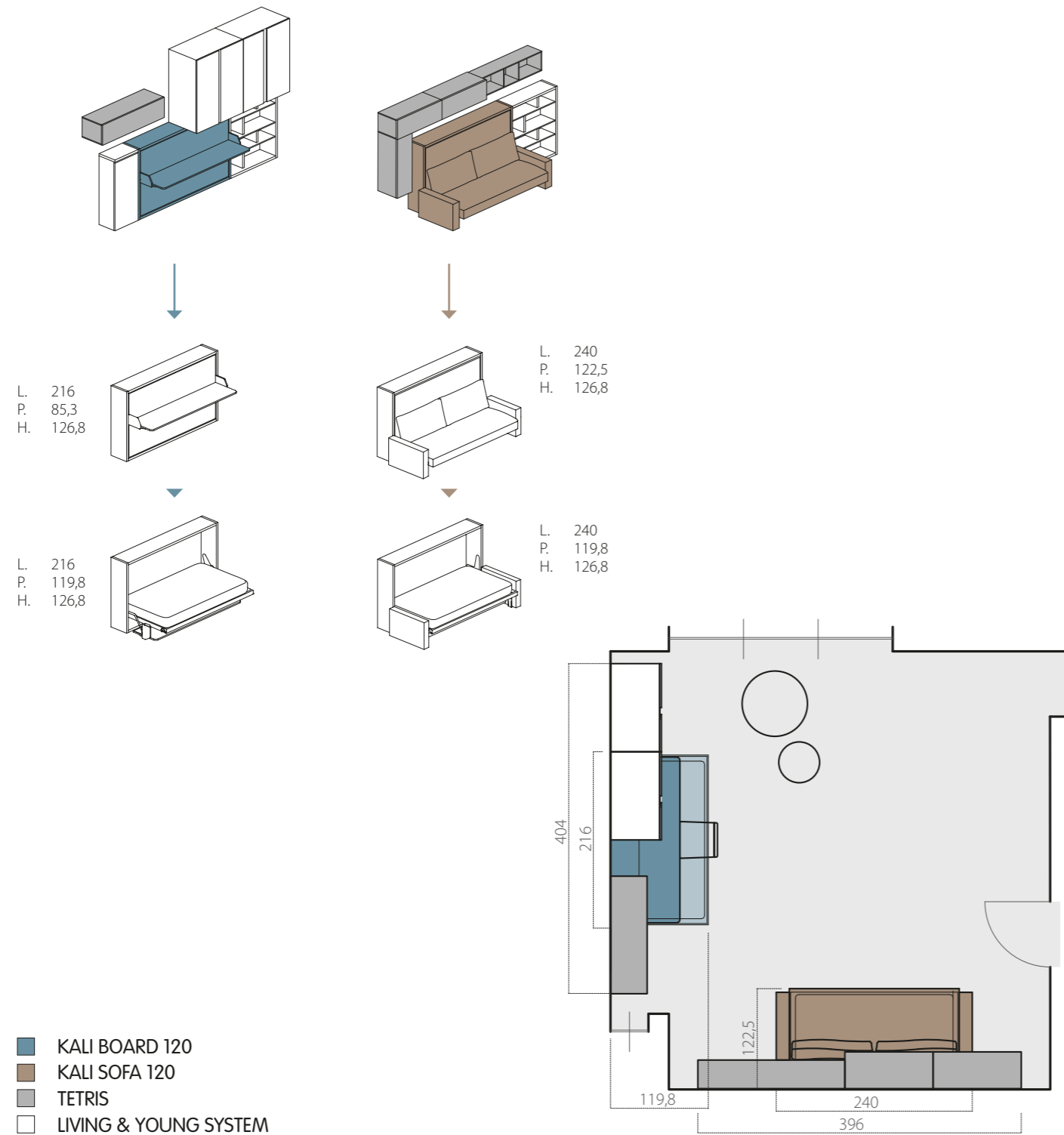

KALI BOARD 120

Rete CF09.
protetta da brevetto
patent protected

Board.
protetto da brevetto
patent protected

KALI SOFA 120

Rete CF09.
protetta da brevetto
patent protected

Sofa.
protetto da brevetto
patent protected

Nelle immagini:
il sistema Kali nelle versioni
Board e Sofa integrato nei
programmi Living & Young
System, con elementi pensili
Tetris, libreria ed elementi
armadio con anta a gola.

Pictured:
the Kali system in the Board
and Sofa versions integrated
in the Living & Young
System programs, with
bookcase elements, Tetris
wall units and wardrobe
elements with
handleless doors.

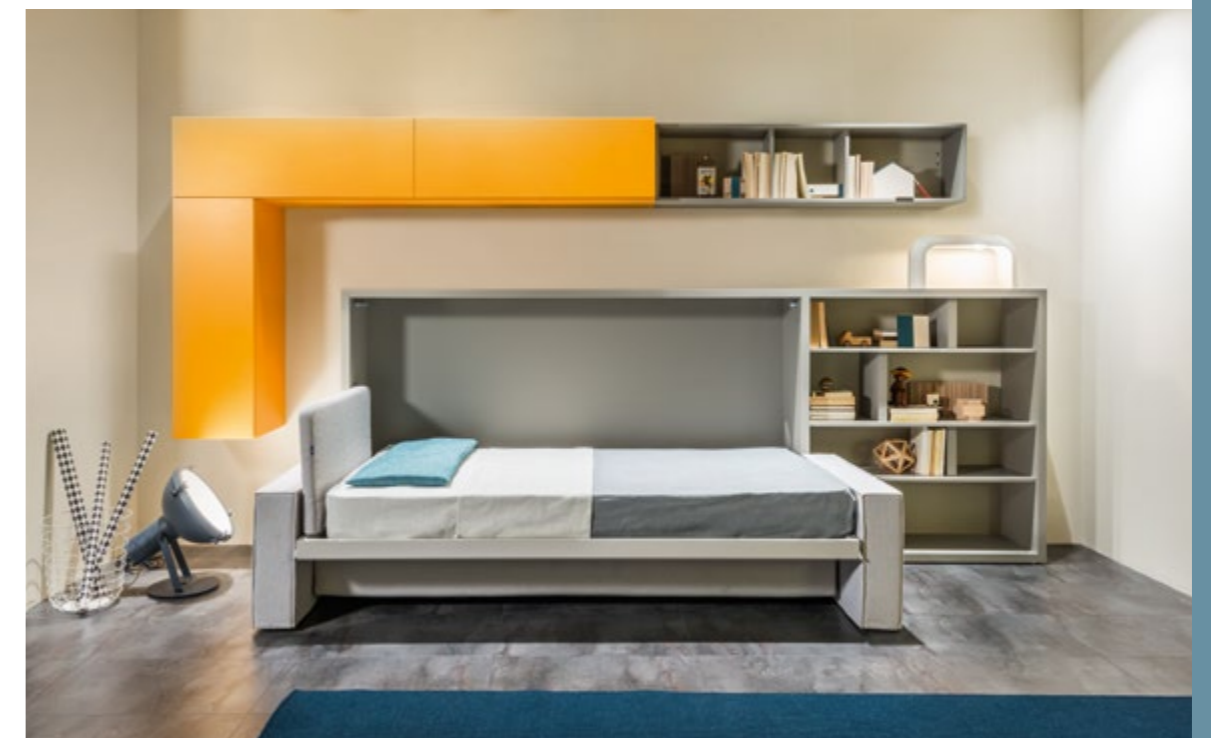



KALI BOARD 120

Sistema trasformabile Kali con letto singolo (90 cm) o intermedio (120 cm) a scomparsa, con rete a doghe brevettata CF09, testata tessile reclinabile e scrittoio maxi brevettato.

Sistema con apertura abbattibile e dotato del dispositivo di sicurezza che impedisce aperture e chiusure accidentali.

Meccanismo di articolazione con molle a gas e dispositivo di movimento ammortizzato, totalmente incassato nel fianco del mobile mediante tecnologia brevettata e speciale lavorazione.

Il sistema trasformabile con un semplice movimento si trasforma nella versione notte senza rimuovere nulla dal grande piano scrittoio che bascula e si posiziona orizzontalmente sotto al letto.

Il sistema trasformabile Kali si articola nelle versioni Standard (con letto orizzontale singolo 90 cm e intermedio 120 cm), Board (letto singolo o intermedio, con scrittoio), Sofa (letto singolo o intermedio, con divano).

Kali transforming system features a tilting single (90 cm) or intermediate (120 cm) bed, with patented CF09 slatted bed base, a reclining fabric headboard and a patented large desk.

The tilting opening system is fitted with a safety device preventing accidental opening and closing.

Tilting mechanism through gas springs and device that cushions movements, completely contained in the side of the structure, thanks to patented technology and special manufacturing.

The system transforms into the night-time position in one simple movement, without the user having to remove anything from the desk which pivots and slots in horizontally underneath the bed.

Kali transforming system is available in the Standard (horizontal 90 cm single or 120 cm intermediate bed), Board (single or intermediate bed, with desk) and Sofa (single or intermediate bed, with sofa) versions.

Scrittoio/Desk
cm L 203,1 x P 50,3 x H 72

Mobile Letto chiuso/Plain System with closed bed
cm L 216 x P 35 x H 126,8

Mobile Letto chiuso + Scrittoio/Plain System with closed bed + Desk
cm L 216 x P 85,3 x H 126,8

—
Mobile Letto aperto/System with open bed
cm L 216 x P 119,8 x H 126,8

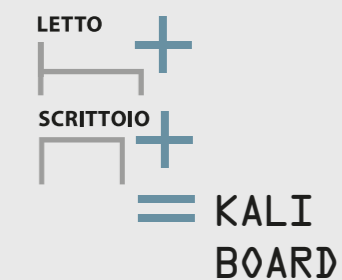

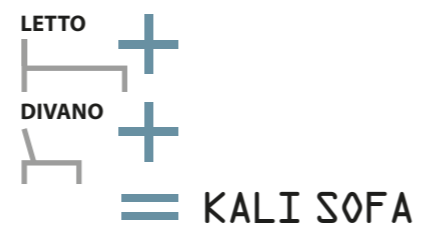

KALI SOFA 120

Kali con letto orizzontale singolo o intermedio (90 e 120 cm), con rete a doghe CF09 e divano, entrambi brevettati, che con un semplice movimento si trasforma nella versione notte: rimuovendo i cuscini di schienale, all'apertura del letto, il divano, con struttura basculante arretra e con movimento traslatorio si posiziona sotto il letto.

Divano con rivestimento sfoderabile. Disponibile con braccioli a scelta nella larghezza 4 cm e 16 cm e con cucitura pizzicata. Imbottitura seduta in espanso indeformabile a quote differenziate, rivestito in falda di dacron accoppiato con tela di cotone.

Letto a scomparsa con apertura abbattibile e dispositivo di sicurezza che impedisce aperture e chiusure accidentali.

Meccanismo di articolazione con molle a gas e dispositivo di movimento ammortizzato, totalmente incassato nel fianco del mobile mediante tecnologia brevettata e speciale lavorazione.

Kali with a horizontal single or intermediate (90 and 120 cm) bed with the CF09 bed base and sofa, both patented, which transforms into the night-time version with a simple movement: the backrest cushions are removed and as the lower bed is opened, the sofa tilts backwards and slots in underneath the bed. Sofa with removable covers.

Available with a choice of armrests 4 cm or 16 cm wide and with French stitching. Seat padding made of graduated non-deformable foam covered with dacron bonded with cotton cloth.

Foldaway bed with a fold-down opening mechanism and safety device that prevents accidental opening and closing.

Tilting mechanism with gas springs and device that cushions movements, completely contained in the side of the structure, thanks to patented technology and special manufacturing.

Divano braccioli L cm 16/Sofa with armrests cm 16 wide cm L 240 x P 87,5 x H 80

Mobile Letto chiuso/Plain System with closed bed cm L 216 x P 35 x H 126,8

Mobile Letto chiuso + Divano/
Plain System with closed bed + Sofa
cm L 240 x P 122,5 x H 126,8

—
Mobile Letto aperto/System with open bed
cm L 216 x P 119,8 x H 126,8

Ambiente 03

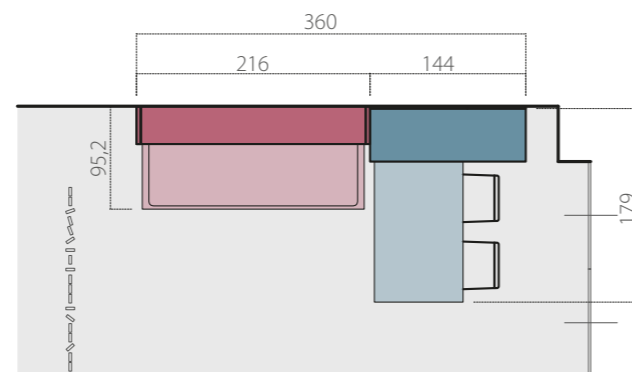
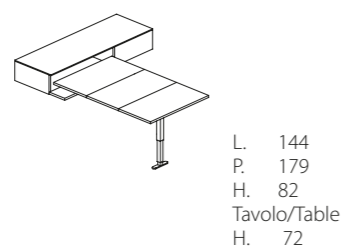
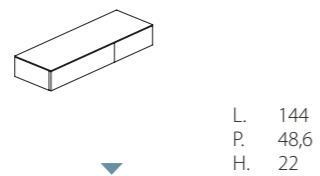
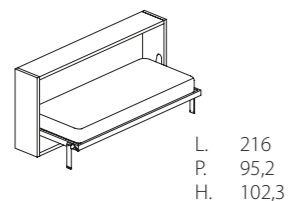
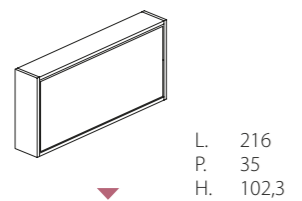
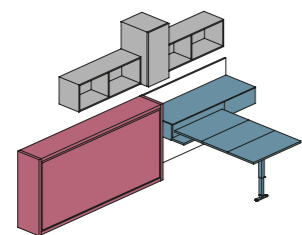

- KALI STANDARD 90
- APP
- TETRIS
- LIVING & YOUNG SYSTEM

KALI STANDARD 90

Rete CF09.
protetta da brevetto
patent protected



Nelle immagini:
composizione con sistema Kali
in versione Standard, tavolo
integrato mod. App e con
elementi pensili a giorno.

Pictured:
composition with Kali system
in the Standard version,
integrated table App and wall
units.





KALI STANDARD 90

Sistema trasformabile Kali in versione Standard: letto orizzontale singolo (90 cm) o intermedio (120 cm) con rete a doghe brevettata CF09 e testata tessile reclinabile, con apertura abbattibile e dotato del dispositivo di sicurezza che impedisce aperture e chiusure accidentali. Meccanismo di articolazione con molle a gas e dispositivo di movimento ammortizzato, totalmente incassato nel fianco del mobile mediante tecnologia brevettata e speciale lavorazione.

Kali transforming system in the Standard version: horizontal single (90 cm) or intermediate bed (120 cm) with patented CF09 slatted bed base and reclining fabric headboard, features a fold-down opening mechanism and safety device that prevents accidental opening and closing. Tilting mechanism with gas springs and device that cushions movements, completely contained in the side of the structure, thanks to patented technology and special manufacturing.

Mobile Letto chiuso/
System with closed bed
cm L 216 x P 35 x H 102,3

—
Mobile Letto aperto/
System with open bed
cm L 216 x P 95,2 x H 102,3

LETTO
A SCOMPARSA

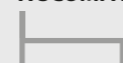

— KALI
STANDARD

APP

App è un tavolo estraibile inserito in un elemento contenitore singolo con anta di chiusura a ribalta, con o senza cassetto laterale, da fissare a muro o su boiserie.

App is a pull-out table fitted into a case element with closing flapping door, with or without lateral drawer, to be fixed on the wall or on a boiserie panel.

Chiuso, con cassetto/Closed, with drawer
cm L 144 x P 48,6 x H 22/82 (da terra/from floor)

—
Aperto/Open
cm L 144 x P 179 x H 82

Tavolo/Table
cm L 82 x P 130 x H 72

MENSOLO
CASSETTO

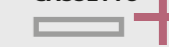

TAVOLO
ESTRAIBILE

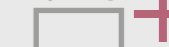

— APP





KALI SOFA 120

Kali con letto orizzontale singolo o intermedio (90 e 120 cm), con rete a doghe CF09 e divano, entrambi brevettati, che con un semplice movimento si trasforma nella versione notte: rimuovendo i cuscini di schienale, all'apertura del letto, il divano, con struttura basculante arretra e con movimento traslatorio si posiziona sotto il letto.

Divano con rivestimento sfoderabile. Disponibile con braccioli a scelta nella larghezza 4 cm e 16 cm e con cucitura pizzicata. Imbottitura seduta in espanso indeformabile a quote differenziate, rivestito in falda di dacron accoppiato con tela di cotone.

Letto a scomparsa con apertura abbattibile e dispositivo di sicurezza che impedisce aperture e chiusure accidentali. Meccanismo di articolazione con molle a gas e dispositivo di movimento ammortizzato, totalmente incassato nel fianco del mobile mediante tecnologia brevettata e speciale lavorazione.

Kali with a horizontal single or intermediate (90 and 120 cm) bed with the CF09 bed base and sofa, both patented, which transforms into the night-time version with a simple movement: the backrest cushions are removed and as the lower bed is opened, the sofa tilts backwards and slots in underneath the bed.

Sofa with removable covers. Available with a choice of armrests 4 cm or 16 cm wide and with French stitching. Seat padding made of graduated non-deformable foam covered with dacron bonded with cotton cloth.

Foldaway bed with a fold-down opening mechanism and safety device that prevents accidental opening and closing. Tilting mechanism with gas springs and device that cushions movements, completely contained in the side of the structure, thanks to patented technology and special manufacturing.

Divano braccioli L cm16/
Sofa with armrests cm 16 wide
cm L 240 x P 87,5 x H 80

Mobile Letto chiuso/Plain System with closed bed
cm L 216 x P 35 x H 126,8

Mobile Letto chiuso + Divano/
Plain System with closed bed + Sofa
cm L 240 x P 122,5 x H 126,8

Mobile Letto aperto/System with open bed
cm L 216 x P 119,8 x H 126,8



ALTEA BOOK 90 STANDARD - P.62,3

Mobile Letto chiuso/Plain System with closed bed
cm L 101 x P 62,3 x H 220

Mobile Letto aperto/System with open bed
cm L 101 x P 241,2 x H 220

Mensola + Testata/Bookshelf + Headboard
cm L 93 x P 28,7 x H 210,7

Mobile trasformabile con letto singolo o intermedio a scomparsa, rete a doghe brevettata CF09, con apertura abbattibile e dispositivo di sicurezza che impedisce aperture e chiusure accidentali.

Meccanismo di articolazione con molle a gas e dispositivo di movimento ammortizzato, totalmente incassato nel fianco del mobile mediante tecnologia brevettata e speciale lavorazione.

Il modello è realizzato nelle profondità 35 cm (con testata letto tessile) e 62,3 cm (con testata letto legno, contenitore porta guanciali e mensola) e si articola nelle versioni Standard, Work (tavolo), Board (scrivania maxi), Sofa.

Transforming system with a foldaway single or intermediate bed, patented CF09 slatted bed base, with a fold-down opening mechanism and safety device that prevents accidental opening and closing.

Tilting mechanism with gas springs and device that cushions movements, completely contained in the side of the structure, thanks to patented technology and special manufacturing.

The model is produced with depth 35 cm (with fabric headboard) and 62,3 cm (with wooden headboard, pillow compartment and shelves) and it is available in the Standard, Work (table), Board (large desk), Sofa versions.





WALLY

Elemento contenitore attrezzato, con tavolo integrato con apertura a ribalta.

Con un semplice movimento le gambe in metallo riposte lateralmente al piano si sganciano e si autobloccano nella posizione di servizio.

Realizzato in melaminico bianco e laccato, nelle versioni con schienale attrezzato con 2 mensole o con schienale magnetico con 4 mensole organizzabili.

In una situazione spazio giovani funge anche da scrittoio.

Case element equipped with integrated table with tilting opening.

Through a simple movement, the metal legs placed on the side of the top are released, and they self-lock in the operating position. Available in melamine white and lacquered finish in the configuration with back panel equipped with 2 shelves or with magnetic back panel with 4 movable shelves.

In a children's room, it is a writing desk as well.

Chiuso/Closed (total)
cm L 71,8 x P 15 x H 153,5/213,5 (da terra/from floor)

Aperto/Open (total)
cm L 71,8 x P 152 x H 153,5/213,5 (da terra/from floor)

Tavolo/Table
cm L 67,4 x P 140 x H 74

TAVOLO A
RIBALTA
INTEGRATO



ELEMENTO
CONTENITORE
ATTEZZATO



WALLY

Ambiente 05

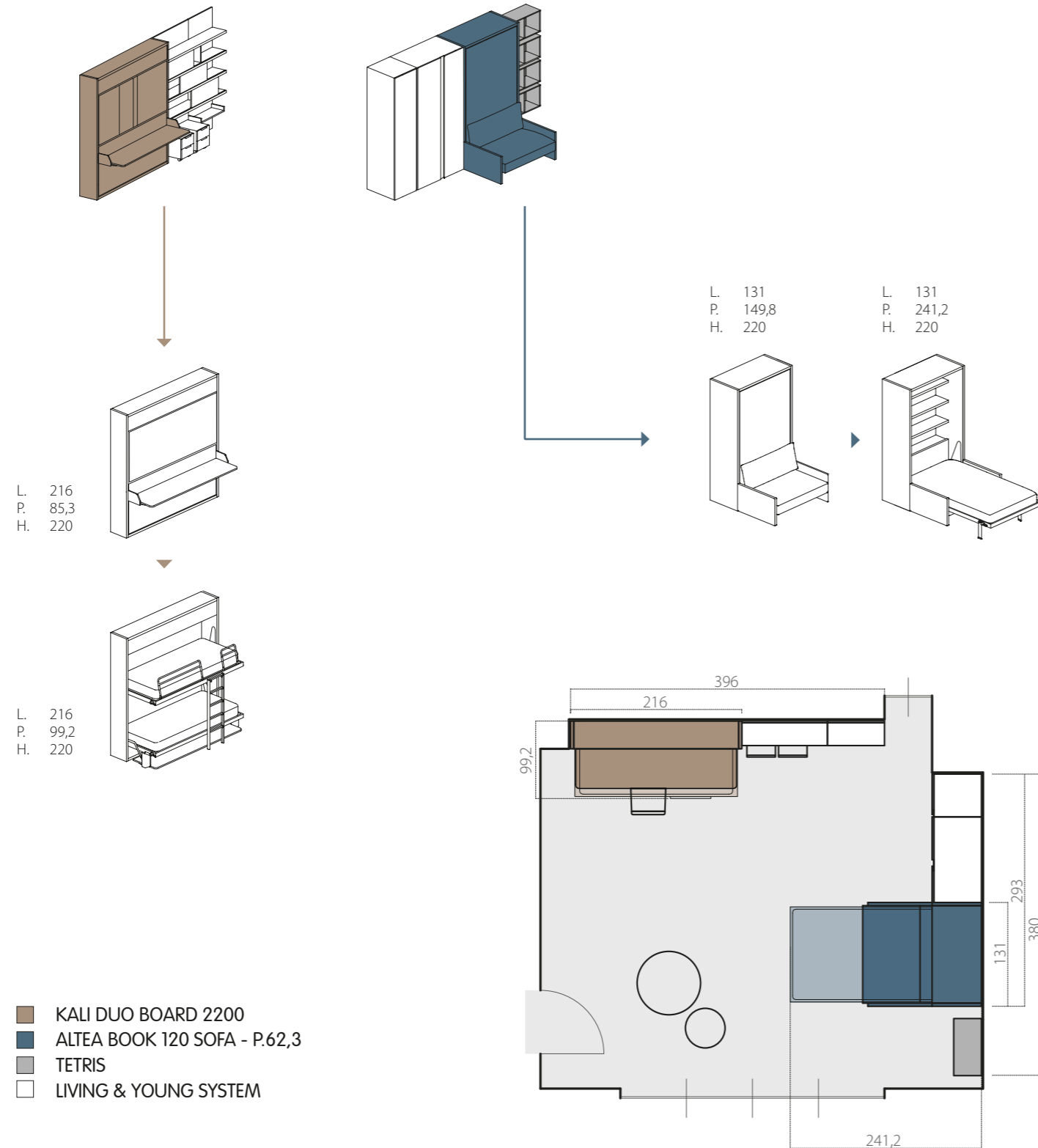

KALI DUO BOARD 2200

Rete CF09.
protetta da brevetto
patent protected

Board.
protetto da brevetto
patent protected

Kali Duo.
protetto da brevetto
patent protected

ALTEA BOOK 120 SOFA - P.62,3

Rete CF09.
protetta da brevetto
patent protected

Sofa.
protetto da brevetto
patent protected

Nelle immagini:
sistema Kali Duo Board
2200 con libreria e mobile
trasformabile Altea Book
120 Sofa - P.62,3 con frontale
decoro integrato con elementi
giorno e armadio.

Pictured:
Kali Duo Board 2200
system with bookcase and
transforming Altea Book 120
Sofa - P.62,3 with decorated
front integrated with shelving
and wardrobe elements.







KALI DUO BOARD 2200

Kali Duo Board è un sistema trasformabile letti a castello a scomparsa con rete a doghe CF09 scrittoio maxi, entrambi brevettati, che con un semplice movimento si trasforma nella versione notte senza rimuovere nulla dal piano scrittoio che bascula e si posiziona orizzontalmente sotto il letto inferiore.

Sistema con apertura abbattibile e dotato del dispositivo di sicurezza che impedisce aperture e chiusure accidentali.

Meccanismo di articolazione con molle a gas e dispositivo di movimento ammortizzato, totalmente incassato nel fianco del mobile mediante tecnologia brevettata e speciale lavorazione.

Nella posizione con letti a castello, la scaletta in alluminio anodizzato, è fissata ad entrambi i letti e funge anche da ulteriore supporto.

Il letto superiore è dotato del meccanismo di inclinazione per facilitarne il rifacimento, e le barriere di protezione sono reclinabili nelle versioni metallo e imbottite. La testata tessile è reclinabile, in base al tipo di barriera utilizzata. Kali Duo ha un sistema luce LED con paracolpi, certificato e conforme alla normativa in materia.

Il mobile è realizzato nelle altezze 194,3 e 220 cm; in H 220 cm è completo di elemento contenitore con anta a scomparsa.

Kali Duo è disponibile nelle versioni Standard, Board (scrittoio maxi), Sofa.

Kali Duo Board is a transforming foldaway bunk bed system with the CF09 slatted bed base and a large desk, both patented, which transforms into the night-time version with a simple movement without the need to remove anything from the large desk that tilts and slots in horizontally underneath the bed.

The system features a fold-down opening mechanism and safety device that prevents accidental opening and closing.

Tilting mechanism with gas springs and device that cushions movements, completely contained in the side of the structure, thanks to patented technology and special manufacturing. In the bunk bed position, the anodised aluminium ladder is fixed to both the beds and also acts as an additional support.

The upper bed features a mechanism to pull upper bed down to make bed easier and the protection barriers are reclining in the metal and padded versions.

The fabric headboard reclines, depending on the kind of barrier used. Kali Duo has a LED light system with a certified anti-shock mechanism in compliance with relevant regulations. The system is produced 194,3 or 220 cm; high H 220 cm features a storage element with a tilting door. Kali Duo is available in the Standard, Board (large desk), Sofa versions.

Scrittoio/Desk
cm L 203,1 x P 50,3 x H 72

Mobile Letto chiuso/Plain System with closed bed
cm L 216 x P 35 x H 220

Mobile Letto chiuso + Scrittoio/
Plain System with closed bed + Desk
cm L 216 x P 85,3 x H 220

—
Mobile Letto aperto/System with open bed
cm L 216 x P 99,2 x H 220

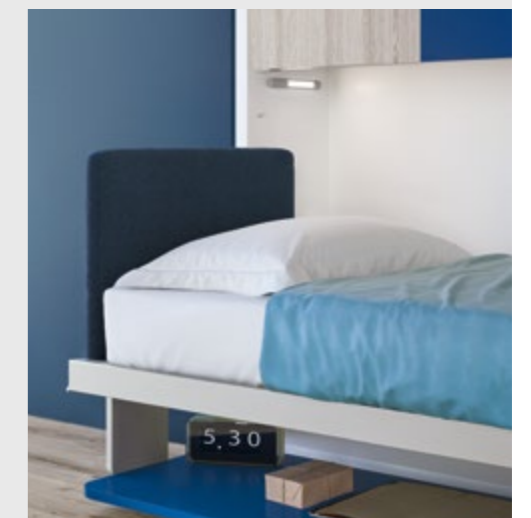



Nelle immagini:
 dettaglio del letto superiore meccanizzato per facilitarne il rifacimento e barriere di protezione reclinabili mediante snodi, che fungono da blocco di sicurezza della barriera.

Pictured:
 the upper bed features a mechanised detail to make the bed easier and reclining protection barriers with joints that act as safety block for the barrier.

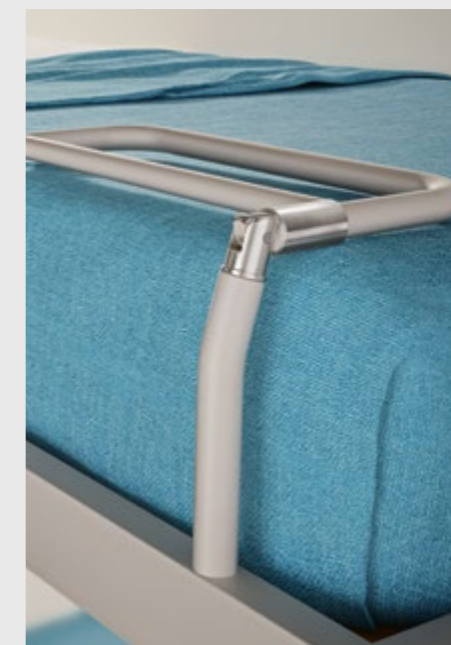



ALTEA BOOK 120 SOFA - P.62-3

Altea Book è un mobile trasformabile con letto singolo o intermedio, rete a doghe CF09 e con divano, entrambi brevettati.

Letto con apertura abbattibile e dotato del dispositivo di sicurezza che impedisce aperture e chiusure accidentali.

Meccanismo di articolazione con molle a gas e dispositivo di movimento ammortizzato, totalmente incassato nel fianco del mobile mediante tecnologia brevettata e speciale lavorazione.

Altea Book nella versione Sofa: all'apertura del letto, rimuovendo i cuscini di schienale, il divano con struttura basculante arretra e con movimento traslatorio si posiziona sotto il letto.

Il divano è disponibile con due tipi di braccioli di misure diverse (L 4 cm e 16 cm).

Imbottitura seduta in espanso indeformabile a quote differenziate rivestito in falda di dacron accoppiata con tela di cotone. Schienali imbottiti in piumafill rivestiti con tela di cotone.

Rivestimento sfoderabile con cucitura pizzicata. Il modello realizzato nella profondità 35 cm (con testata letto tessile) e 62,3 cm (con testata letto in legno, contenitore porta guanciali e mensole) si articola nelle versioni Standard, Work (tavolo), Board (scrittoio maxi), Sofa.

Divano braccioli L cm 4/
Sofa with armrests cm 4 wide
cm L 131 x P 87,5 x H 80

Mobile Letto chiuso/
Plain System with closed bed
cm L 131 x P 62,3 x H 220

Mobile Letto chiuso + Divano/
Plain System with closed bed + Sofa
cm L 131 x P 149,8 x H 220

—
Mobile Letto aperto/
System with open bed
cm L 131 x P 241,2 x H 220

Mensole + Testata/
Bookshelf + Headboard
cm L 123 x P 28,7 x H 210,7

Altea Book is a transforming system with single or intermediate bed, with a CF09 slatted bed base and sofa, which are both patented.

The bed features a fold-down opening mechanism and safety device that prevents accidental opening and closing.

Tilting mechanism with gas springs and device that cushions movements, completely contained in the side of the structure, thanks to patented technology and special manufacturing.

Altea Book in the Sofa version: the backrest cushions are removed and as the bed is opened, the sofa tilts backwards and slots in underneath the bed.

The sofa is available with two types of armrest in different sizes (W 4 cm and 16 cm).

Seat padding made of graduated non-deformable foam covered with dacron bonded with cotton cloth. The backrests are padded with piumafill and upholstered with cotton cloth.

Removable covers with French stitching. The model is produced with depth 35 cm (with fabric headboard) and 62,3 cm (with wooden headboard, pillow compartment and shelves) and it is available in the Standard, Work (table), Board (large desk), Sofa versions.



**ALTEA BOOK
SOFA - P.62-3**



Kali Duo Sofa 2200

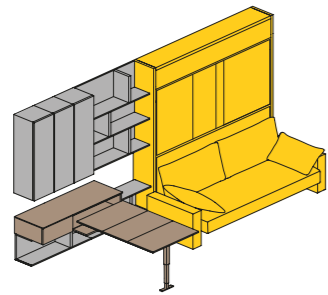

KALI DUO SOFA 2200 presentazione tecnica technical presentation

L. 144
P. 48,6
H. 22

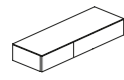

L. 144
P. 179
H. 82
Tavolo/Table
H. 72

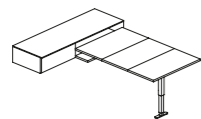

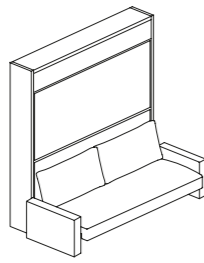

L. 240
P. 122,5
H. 220

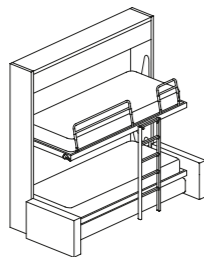

L. 240
P. 118
H. 220



 KALI DUO SOFA 2200
 APP » pg. 32
 TETRIS

Kali Duo Sofa è un sistema trasformabile con letti a castello a scomparsa e con rete a doghe brevettata CF09 e con divano brevettato che con un semplice movimento si trasforma nella versione notte: rimuovendo i cuscini di schienale, con l'apertura del letto inferiore, il divano con struttura basculante arretra e con movimento traslatorio si posiziona sotto al letto. Sistema con apertura abbattibile e dotato del dispositivo di sicurezza che impedisce aperture e chiusure accidentali.

Meccanismo di articolazione con molle a gas e dispositivo di movimento ammortizzato, totalmente incassato nel fianco del mobile mediante tecnologia brevettata e speciale lavorazione.

Nella posizione con letti a castello, la scaletta in alluminio anodizzato, è fissata ad entrambi i letti e funge anche da ulteriore supporto. Il letto superiore è dotato del meccanismo di inclinazione per facilitarne il rifacimento, le barriere di protezione sono reclinabili, nelle versioni metallo e imbottite. La testata tessile è reclinabile, in base al tipo di barriera utilizzata. Kali Duo ha un sistema luce LED con paracolpi, certificato e conforme alla normativa in materia.

Il mobile è realizzato nelle altezze 194,3 e 220 cm; in H 220 cm è completo di elemento contenitore con anta a ribalta.

Kali Duo è disponibile anche nelle versioni Standard e Board (scrittoio maxi).

Kali Duo Sofa is a transforming foldaway bunk bed system with the patented CF09 slatted bed base and patented sofa, which transforms into the night-time version with a simple movement: the backrest cushions are removed and as the lower bed is opened, the sofa tilts backwards and slots in underneath the bed. The system features a fold-down opening mechanism and safety device that prevents accidental opening and closing. Tilting mechanism with gas springs and device that cushions movements, completely contained in the side of the structure, thanks to patented technology and special manufacturing.

In the bunk bed position, the anodised aluminium ladder is fixed to both the beds and also acts as an additional support.

The upper bed features a mechanism to pull bed down to make the bed easier, and the protection barriers are reclining in the metal and padded versions.

The fabric headboard reclines, depending on the kind of barrier used. Kali Duo has a LED light system with a certified anti-shock mechanism in compliance with relevant regulations.

The system is produced 194,3 or 220 cm; high H 220 cm features a storage element with a tilting door. Kali Duo is also available in the Standard and Board (large desk) versions.

Divano braccioli L cm 16/Sofa with armrests 16 cm wide
cm L 240 x P 87,5 x H 80

Mobile Letto chiuso/Plain System with closed bed
cm L 216 x P 35 x H 220

Mobile Letto chiuso + Divano/
Plain System with closed bed + Sofa
cm L 240 x P 122,5 x H 220

—
Mobile Letto aperto/System with open bed
cm L 240 x P 118 x H 220

KALI DUO SOFA 2200

Rete CF09.
protetta da brevetto
patent protected

Kali Duo.
protetto da brevetto
patent protected

Sofa.
protetto da brevetto
patent protected

Nelle immagini:
composizione multifunzionale
con sistema Kali Duo, letti a
castello e divano, elementi
Tetris libreria e pensili con anta
e cassetto con tavolo estraibile
mod. App.

Pictured:
multi-functional composition
featuring Kali Duo system with
bunk beds and sofa, Tetris
bookcase, wall units with door,
App pull-out table, drawer.



Nell'immagine:
letto superiore con meccanismo di
inclinazione integrato per facilitarne il
rifacimento e barriere di sicurezza reclinabili.

Pictured:
upper bed with integrated pull-down
mechanism to facilitate making the bed and
reclining safety barriers.



- LETTO +
- LETTO +
- DIVANO +
- == KALI DUO
SOFA



Kali Duo Standard 2200

KALI DUO STANDARD 2200 presentazione tecnica technical presentation

Kali Duo in versione Standard con o senza elemento contenitore (H 220 cm e 194,3 cm) è un sistema trasformabile con letti a castello orizzontali a scomparsa, con rete a doghe brevettata CF09, apertura abbattibile e sistema di sicurezza per impedire aperture e chiusure accidentali.

Il meccanismo di articolazione con molle a gas e dispositivo di movimento ammortizzato è totalmente incassato nel fianco del mobile, con tecnologia brevettata e speciale lavorazione.

Il sistema nella posizione a castello si compone con scaletta in alluminio anodizzato fissata ad entrambi i letti che ha anche funzione di ulteriore supporto portante.

Barriere di protezione reclinabili nelle versioni metallo e imbottite.

Testata imbottita reclinabile in base al tipo di barriera utilizzata, meccanismo di inclinazione integrato nel letto superiore per facilitarne il rifacimento, e sistema luce LED con paracolpi certificato e conforme alla normativa in materia.

Kali Duo è disponibile nelle versioni Standard, Board (scrivitoio maxi), Sofa.

Chiuso/Closed
cm L 216 x P 35 x H 220

—
Aperto/Open
cm L 216 x P 99,2 x H 220

Kali Duo in the Standard version with or without a container element (H 220 cm and 194,3 cm) is a transforming system with foldaway horizontal bunk beds, with the patented CF09 slatted bed base, folding opening and a safety system to prevent accidental opening and closing.

Tilting mechanism through gas springs and device that cushions movements, completely contained in the side of the structure, thanks to patented technology and special manufacturing.

When the bunk beds are out, an anodised aluminium ladder is fixed to both beds and acts as an additional supporting element.

Reclining safety barriers are available in metal or upholstered versions.

Reclining, padded headboard depending on type of barrier used, integrated mechanism to pull upper bed down to make easier the bed, LED light system with certified anti-shock mechanism complying with relevant regulations.

Kali Duo is available in the Standard, Board (large desk), Sofa versions.

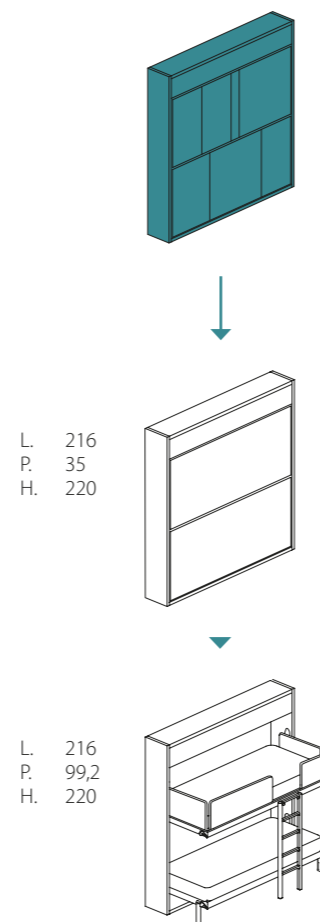

KALI DUO STANDARD 2200

Rete CF09.
protetta da brevetto
patent protected

Kali Duo.
protetto da brevetto
patent protected

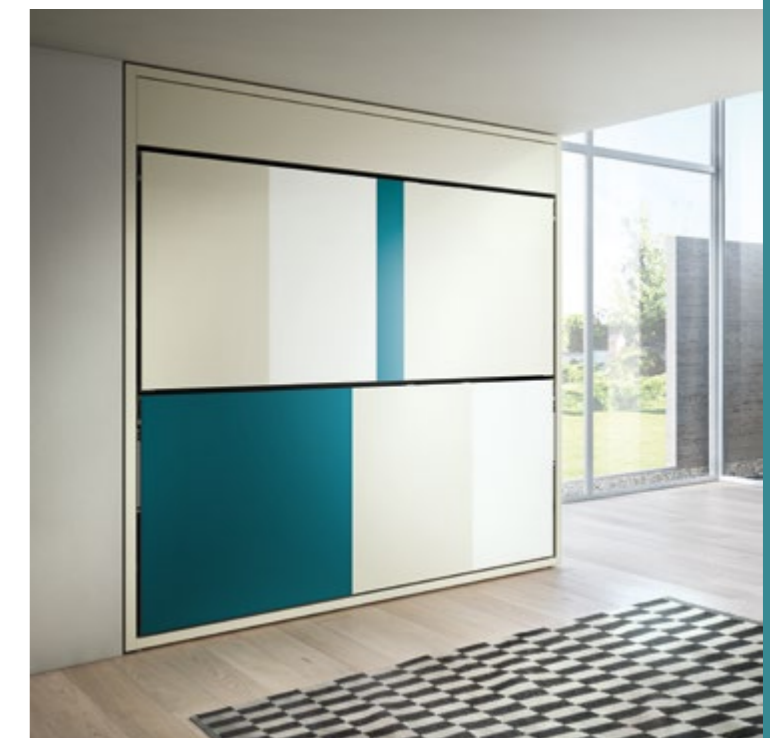

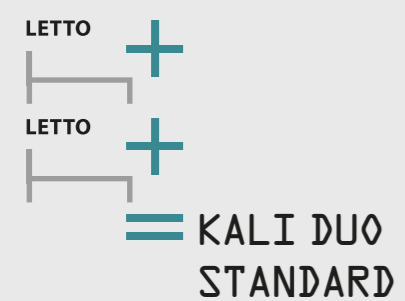

Nell'immagine:
la scaletta si aggancia ad entrambi i letti con innesto automatico.

Pictured:
the ladder is fixed to both beds with quick-release inserts.

Nell'immagine:
letto superiore con meccanismo di inclinazione
integrato per facilitarne il rifacimento e barriere
di sicurezza, reclinabili e imbottite.

Pictured:
upper bed with integrated pull-down
mechanism to facilitate making the bed and
reclining, padded safety barriers.

Ambiente 06

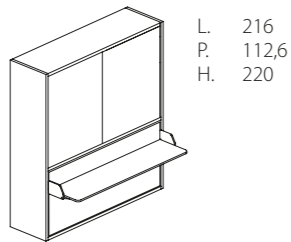
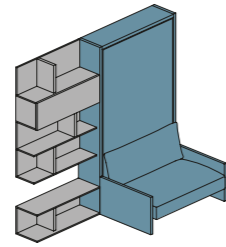
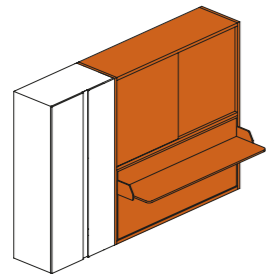

L. 216
P. 112,6
H. 220

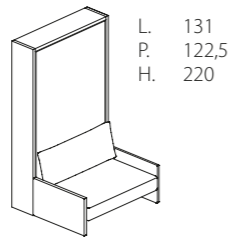

L. 131
P. 122,5
H. 220

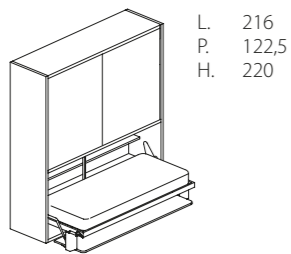

L. 216
P. 122,5
H. 220

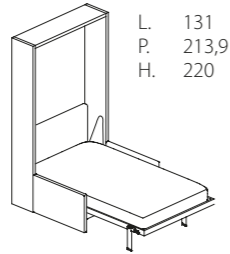

L. 131
P. 213,9
H. 220

- KALI PONTE BOARD 2200
- ALTEA 120 SOFA - P.35
- TETRIS
- LIVING & YOUNG SYSTEM



KALI PONTE BOARD 2200

Rete CF09.
protetta da brevetto
patent protected

Board.
protetto da brevetto
patent protected

ALTEA 120 SOFA - P.35

Rete CF09.
protetta da brevetto
patent protected

Sofa.
protetto da brevetto
patent protected



Nelle immagini:
composizione giorno con
Altea 120 Sofa - P.35 e sistema
Kali Ponte Board, con ante
scorrevoli con decoro.

Pictured:
Shelving composition with
Altea 120 Sofa - P.35 and
Kali Ponte Board system with
sliding doors with decorations.







LETTO +
 DIVANO +
 = ALTEA
 SOFA - P.35

TETRIS

Tetris è un sistema modulare, versatile e componibile, basato sul libero accostamento di elementi integrabili nei programmi Living & Young System. Basi a terra e sospese, elementi giorno, a parete e con ante a ribalta e vasistas, combinabili tra loro in composizioni personalizzate. Una varietà di componenti coordinabili con i sistemi trasformabili, con assoluta libertà progettuale e disponibili nelle varie finiture a campionario.

Tetris is a modular, versatile and sectional system based on the free combination of integrable elements in the Living & Young System programs. Floor and suspended units, open and with flap door, which can be combined together in custom arrangements. A variety of components that can be coordinated with transformable systems with absolute design freedom, available in the collection's various finishes.

ALTEA 120 SOFA - P.35

Altea 120 Sofa - P.35 è un sistema trasformabile a doppia funzione con letto intermedio a scomparsa, disponibile anche con letto singolo, con rete a doghe brevettata CF09 e con divano brevettato che con un semplice movimento si trasforma nella versione notte: rimuovendo i cuscini di schienale all'apertura del letto, il divano, con struttura basculante arretra e con movimento traslatorio si posiziona sotto al letto. Sistema con apertura abbattibile e dotato del dispositivo di sicurezza che impedisce aperture e chiusure accidentali. Meccanismo di articolazione con molle a gas e dispositivo di movimento ammortizzato, totalmente incassato nel fianco del mobile mediante tecnologia brevettata e speciale lavorazione. Divano con imbottitura della seduta in espanso indeformabile a quote differenziate rivestito in falda di dacron accoppiata con tela di cotone. Schienali imbottiti in piumafill rivestiti con tela di cotone. Rivestimento sfoderabile con cucitura pizzicata. Disponibile con due tipi di braccioli di misure diverse (L 4 cm e 16 cm).

Altea 120 Sofa - P.35 is a dual-function transforming system with a foldaway intermediate bed, also available with a single bed, with the patented CF09 slatted bed base and patented sofa, which transforms into the night-time version with a simple movement: the backrest cushions are removed and as the bed is opened, the sofa tilts backwards and slots in underneath the bed. The system features a fold-down opening mechanism and safety device that prevents accidental opening and closing. Tilting mechanism with gas springs and device that cushions movements, completely contained in the side of the structure, thanks to patented technology and special manufacturing. The sofa features seat padding made of graduated non-deformable foam upholstered with dacron bonded with cotton cloth. The backrests are padded with piumafill and upholstered with cotton cloth. Removable covers with French stitching. Available with two types of armrest in different sizes (W 4 cm and 16 cm).

Divano braccioli L cm 4/Sofa with armrests cm 4 wide
 cm L 131 x P 87,5 x H 80
 Mobile Letto chiuso/Plain System with closed bed
 cm L 131 x P 35 x H 220
 Mobile Letto chiuso + Divano/
 Plain System with closed bed + Sofa
 cm L 131 x P 122,5 x H 220
 —
 Mobile Letto aperto/System with open bed
 cm L 131 x P 213,9 x H 220



KALI PONTE BOARD 2200

Sistema componibile trasformabile con letto singolo orizzontale a scomparsa, con rete a doghe brevettata CF09, testata reclinabile e scrittoio maxi brevettato, integrato con elemento armadio ponte, ad ante scorrevoli, disponibile nelle altezze cm 220 e 256,1. Sistema con apertura abbattibile e dotato del dispositivo di sicurezza che impedisce aperture e chiusure accidentali. Meccanismo di articolazione con molle a gas e dispositivo di movimento ammortizzato, totalmente incassato nel fianco del mobile mediante tecnologia brevettata e speciale lavorazione. Il sistema trasformabile con un semplice movimento si trasforma nella versione notte senza rimuovere nulla dal grande piano scrittoio che bascula e si posiziona orizzontalmente sotto al letto.

Transforming modular system with horizontal foldaway single bed with patented CF09 slatted bed base, reclining headboard and large patented desk, integrated with bridge wardrobe element with sliding doors, available 220 and 256,1 cm high. The system features a fold-down opening mechanism and safety device that prevents accidental opening and closing. Tilting mechanism with gas springs and device that cushions movements, completely contained in the side of the structure, thanks to patented technology and special manufacturing. With a simple movement, the system transforms into the night-time version without the need to remove anything from the large desk that tilts and slots in horizontally underneath the bed.

Scrittoio/Desk
cm L 203,1 x P 50,3 x H 72
Mobile Letto chiuso/Plain System with closed bed
cm L 216 x P 62,3 x H 220
Mobile Letto chiuso + Scrittoio/
Plain System with closed bed + Desk
cm L 216 x P 112,6 x H 220
—
Mobile Letto aperto/System with open bed
cm L 216 x P 122,5 x H 220
Mensola/Bookshelf
cm L 208 x P 19,4 x H 93



Nell'immagine:
dettaglio del sistema di apertura Kali Ponte Board con scrittoio basculante.

Pictured:
detail of the Kali Ponte Board opening system with tilting desk.

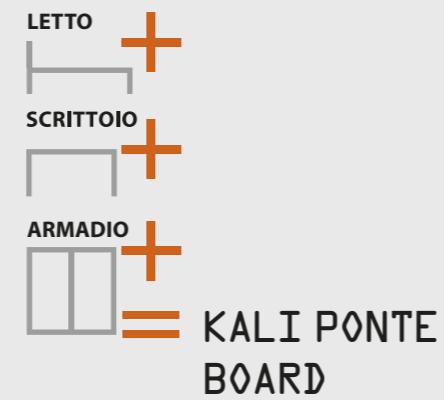

Ambiente 07

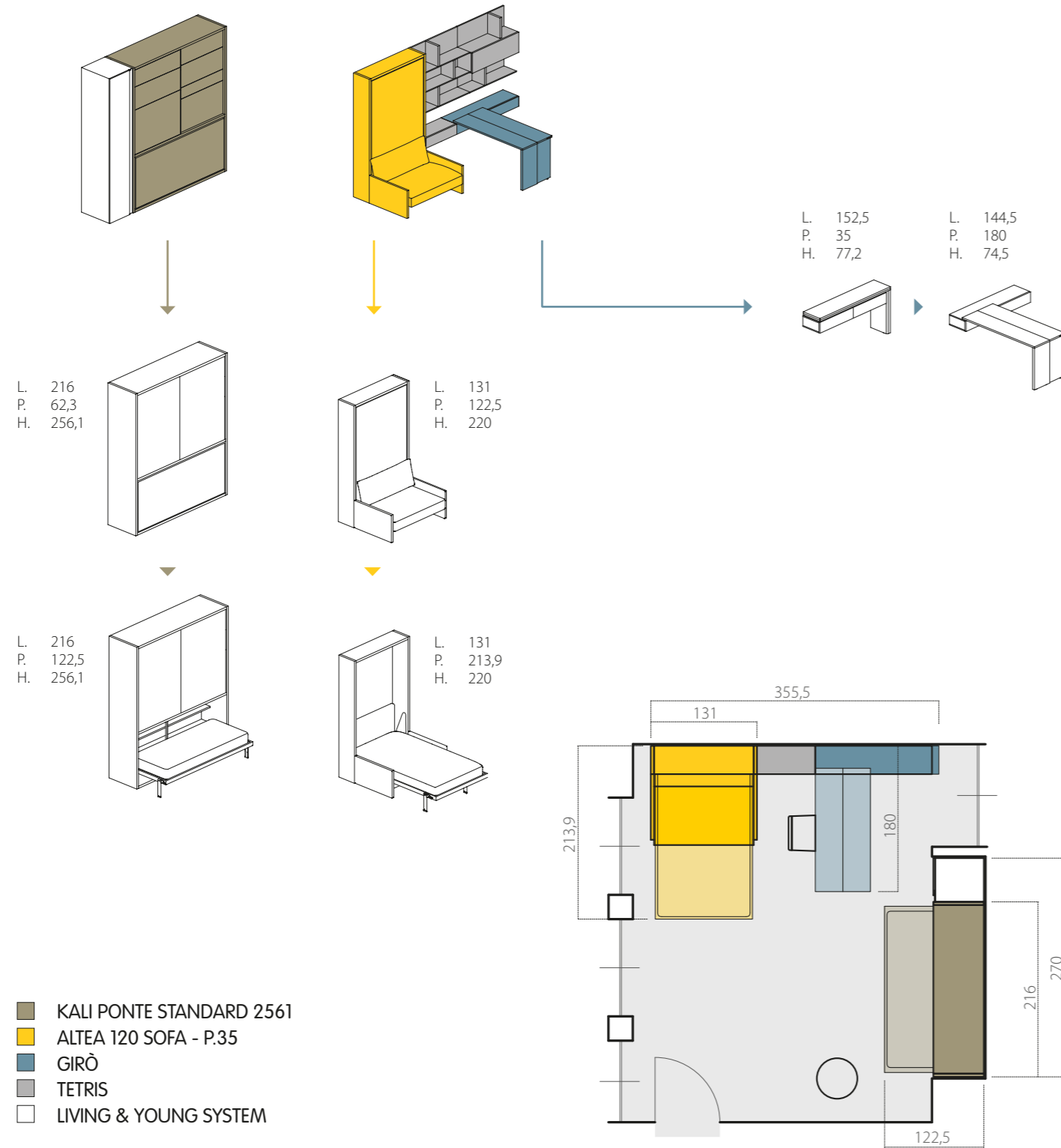

KALI PONTE STANDARD 2561

Rete CF09.
protetta da brevetto
patent protected

ALTEA 120 SOFA - P.35

Rete CF09.
protetta da brevetto
patent protected

Sofa.
protetto da brevetto
patent protected



Nelle immagini:
l'ambiente è arredato con la
composizione multifunzionale
Altea 120 Sofa - P.35 con letto
intermedio, divano e tavolo
Girò e con il sistema Kali Ponte
in versione Standard con
armadio a ante scorrevoli.

Pictured:
the room is furnished with the
multi functional composition
Altea 120 Sofa - P.35 with
intermediate bed, sofa and
Girò table and with Kali Ponte
system in the Standard version
with sliding doors wardrobe.







TAVOLO



ELEMENTO CONTENITORE



CONSOLLE

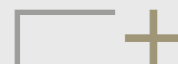

≡ GIRÒ

GIRÒ

Tavolo/consolle con meccanismo rotante e apertura a libro. Il sistema vincolato e sovrapposto all'elemento contenitore (L 144,5 cm x P 35 cm x H 18 cm con cassetti e H 36 cm con anta a ribalta) si trasforma in un tavolo.

Il sistema tavolo/consolle è composto da due piani con apertura a libro, con gamba di supporto e meccanismo rotante.

Table/console table with rotating mechanism and bifold opening system. The system is fixed to and fits over the compartment section (W 144,5 cm x D 35 cm x H 18 cm with drawers and H 36 cm with flip-down door) and becomes a table. The table/console table system is composed of two bifolding tops, with supporting leg and rotating mechanism.

Chiuso/Closed (total)
cm L 152,5 x P 35 x H 77,2

—
Aperto/Open (total)
cm L 144,5 x P 180 x H 74,5

—
Tavolo/Table
cm L 68 x P 152,5 x H 74,5

LETTO

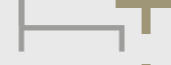

DIVANO

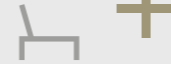

≡ ALTEA
SOFA - P.35

Divano braccioli L cm 4/
Sofa with armrests cm 4 wide
cm L 131 x P 87,5 x H 80

—
Mobile Letto chiuso/
Plain System with closed bed
cm L 131 x P 35 x H 220

—
Mobile Letto chiuso + Divano/
Plain System with closed bed + Sofa
cm L 131 x P 122,5 x H 220

—
Mobile Letto aperto/
System with open bed
cm L 131 x P 213,9 x H 220

ALTEA 120 SOFA - P.35

Altea 120 Sofa - P.35 è un sistema trasformabile a doppia funzione con letto intermedio a scomparsa, disponibile anche con letto singolo, con rete a doghe brevettata CF09 e con divano brevettato che con un semplice movimento si trasforma nella versione notte: rimuovendo i cuscini di schienale all'apertura del letto, il divano, con struttura basculante arretra e con movimento traslatorio si posiziona sotto al letto. Sistema con apertura abbattibile e dotato del dispositivo di sicurezza che impedisce aperture e chiusure accidentali. Meccanismo di articolazione con molle a gas e dispositivo di movimento ammortizzato, totalmente incassato nel fianco del mobile mediante tecnologia brevettata e speciale lavorazione. Divano con imbottitura della seduta in espanso indeformabile a quote differenziate rivestito in falda di dacron accoppiata con tela di cotone. Schienali imbottiti in piumafill rivestiti con tela di cotone. Rivestimento sfoderabile con cucitura pizzicata. Disponibile con due tipi di braccioli di misure diverse (L 4 cm e 16 cm).

Altea 120 Sofa - P.35 is a dual-function transforming system with a foldaway intermediate bed, also available with a single bed, with the patented CF09 slatted bed base and patented sofa, which transforms into the night-time version with a simple movement: the backrest cushions are removed and as the bed is opened, the sofa tilts backwards and slots in underneath the bed. The system features a fold-down opening mechanism and safety device that prevents accidental opening and closing. Tilting mechanism with gas springs and device that cushions movements, completely contained in the side of the structure, thanks to patented technology and special manufacturing. The sofa features seat padding made of graduated non-deformable foam upholstered with dacron bonded with cotton cloth. The backrests are padded with piumafill and upholstered with cotton cloth. Removable covers with French stitching. Available with two types of armrest in different sizes (W 4 cm and 16 cm).





LETTO

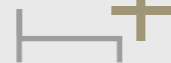

ARMADIO



== KALI PONTE
STANDARD

KALI PONTE STANDARD 256,1

Kali ponte in versione Standard, con armadio a ponte con ante scorrevoli, nelle altezze cm 220 e 256,1 è un sistema componibile trasformabile con letto singolo orizzontale a scomparsa, apertura abbattibile, testata tessile reclinabile, rete a doghe brevettata CF09 e dispositivo di sicurezza che impedisce aperture e chiusure accidentali.

Meccanismo di articolazione con molle a gas e dispositivo di movimento ammortizzato, totalmente incassato nel fianco del mobile mediante tecnologia brevettata e speciale lavorazione.

Kali Ponte è disponibile anche nelle versioni Board (scrittoio maxi), Sofa.

Kali Ponte in the Standard version with a bridge wardrobe with sliding doors, 220 and 256,1 cm high. It is a transforming modular system with a foldaway horizontal single bed, fold-down opening mechanism, reclining fabric headboard, patented CF09 slatted bed base and safety mechanism that prevents accidental opening and closing.

Tilting mechanism with gas springs and device that cushions movements, completely contained in the side of the structure, thanks to patented technology and special manufacturing.

Kali Ponte is also available in the Board (large desk), Sofa versions.

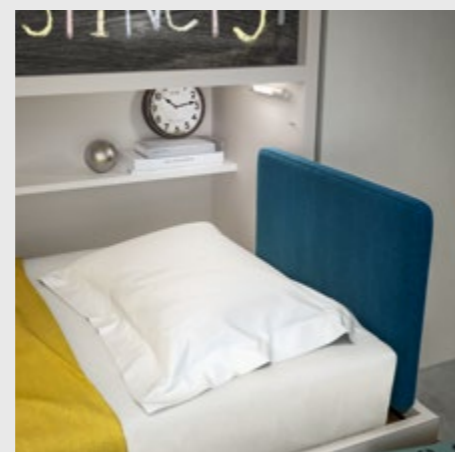
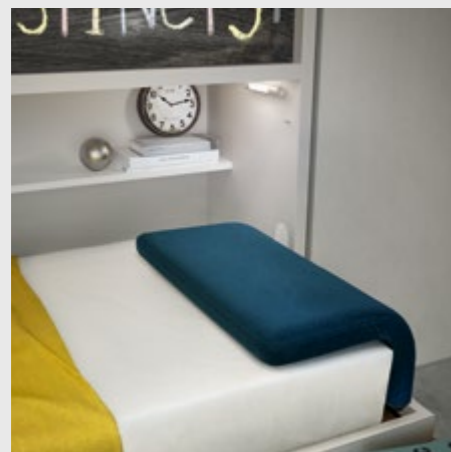

Chiuso/Closed
cm L 216 x P 62,3 x H 256,1

—
Aperto/Open
cm L 216 x P 122,5 x H 256,1
Mensola/Bookshelf
cm L 208 x P 19,4 x H 93



Ambiente 08

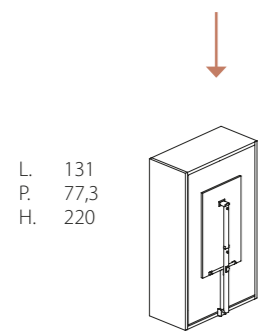
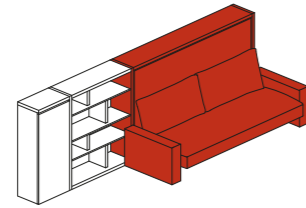
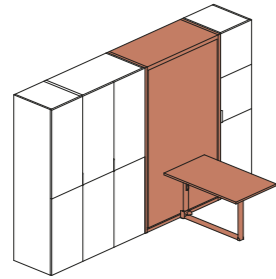

L. 131
P. 77,3
H. 220

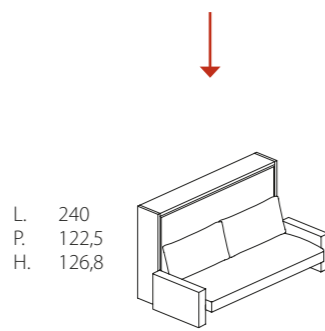

L. 240
P. 122,5
H. 126,8

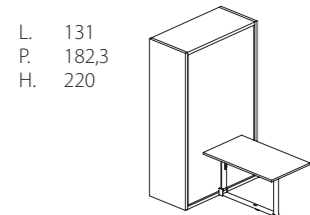

L. 131
P. 182,3
H. 220

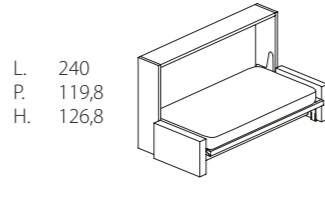

L. 240
P. 119,8
H. 126,8

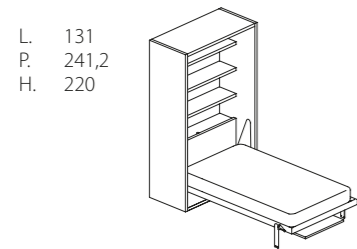

L. 131
P. 241,2
H. 220

- ALTEA BOOK 120 WORK - P.62,3
- KALI SOFA 120
- LIVING & YOUNG SYSTEM

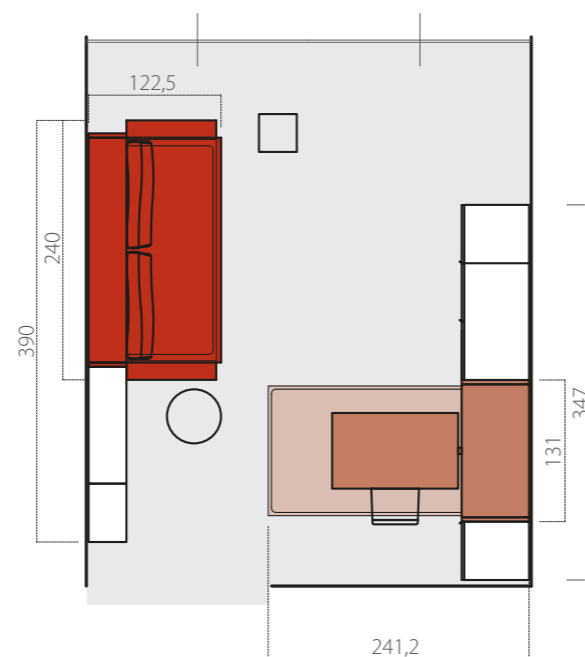

ALTEA BOOK 120 WORK - P.62,3

Rete CF09.
protetta da brevetto
patent protected

Work.
protetto da brevetto
patent protected

KALI SOFA 120

Rete CF09.
protetta da brevetto
patent protected

Sofa.
protetto da brevetto
patent protected

Nelle immagini:
composizione Altea Book
120 Work - P.62,3 integrata
nell'armadiatura e sistema
Kali Sofa 120 coordinato con
elementi dei programmi Living
& Young System.

Pictured:
composition with Altea Book
120 Work - P.62,3 integrated in
the wardrobe system and Kali
Sofa 120 system coordinated
with elements of the Living &
Young System programs.







- LETTO 
- TESTATA
ATTREZZATA 
- TAVOLO 
-  ALTEA BOOK
WORK - P.62-3

ALTEA BOOK 120 WORK - P.62-3

Altea Book 120 Work è un sistema trasformabile a doppia funzione con letto intermedio a scomparsa, disponibile anche con letto singolo, con rete a doghe CF09 e tavolo Work, entrambi brevettati.

Letto con apertura abbattibile e dotato del dispositivo di sicurezza che impedisce aperture e chiusure accidentali e meccanismo di articolazione con molle a gas e dispositivo di movimento ammortizzato, totalmente incassato nel fianco del mobile mediante tecnologia brevettata e speciale lavorazione.

Il modello realizzato nella profondità 35 cm (con testata letto tessile) e 62,3 cm (con testata letto in legno, contenitore porta guanciali e mensole) si articola nelle versioni Standard, Work (tavolo), Board (scrittoio maxi), Sofa.

Altea Book 120, nella versione Work, è caratterizzato da un tavolo meccanizzato (L 70 cm x P 120 cm x H 72 cm) per specifiche funzioni: apertura abbattibile per la funzione tavolo, chiusura verticale parallela alla facciata del mobile per ridurre l'ingombro, e movimento basculante per posizionamento sotto alla rete del letto nella versione notte.

Altea Book 120 Work is a dual-function transforming system with a foldaway intermediate bed, also available with a single bed, with the CF09 slatted bed base and Work table, which are both patented.

Bed with a fold-down opening mechanism, safety device that prevents accidental opening and closing and tilting mechanism with gas springs and device that cushions movements, completely contained in the side of the structure, thanks to patented technology and special manufacturing.

The model is produced with depth 35 cm (with fabric headboard) and 62,3 cm (with wooden headboard, pillow compartment and shelves) and it is available in the Standard, Work (table), Board (large desk), Sofa versions.

In the Work version, Altea Book 120 features a mechanised table (W 70 cm x D 120 cm x H 72 cm) for specific functions: fold-down opening for the table function, vertical closing flush to front of the system to free up space and tilting movement so that it slots in underneath the bed base in the night-time position.

Tavolo aperto/Open Table
cm L 70 x P 120 x H 72

Tavolo chiuso/Closed Table
cm L 70 x P 15 x H 182

Mobile Letto chiuso/
Plain System with closed bed
cm L 131 x P 62,3 x H 220

Mobile Letto chiuso + Tavolo chiuso/
Plain System with closed bed + closed Table
cm L 131 x P 77,3 x H 220

Mobile Letto chiuso + Tavolo aperto/
Plain System with closed bed + open Table
cm L 131 x P 182,3 x H 220

—
Mobile Letto aperto/System with open bed
cm L 131 x P 241,2 x H 220

Mensole + Testata/Bookshelf + Headboard
cm L 123 x P 28,7 x H 210,7





Divano braccioli L cm16/Sofa with armrests cm 16 wide
 cm L 240 x P 87,5 x H 80
 Mobile Letto chiuso/Plain System with closed bed
 cm L 216 x P 35 x H 126,8
 Mobile Letto chiuso + Divano/
 Plain System with closed bed + Sofa
 cm L 240 x P 122,5 x H 126,8
 —
 Mobile Letto aperto/System with open bed
 cm L 216 x P 119,8 x H 126,8

KALI SOFA 120

Kali con letto orizzontale singolo o intermedio (90 e 120 cm), con rete a doghe CF09 e divano, entrambi brevettati, che con un semplice movimento si trasforma nella versione notte: rimuovendo i cuscini di schienale, all'apertura del letto, il divano, con struttura basculante arretra e con movimento traslatorio si posiziona sotto il letto.
 Divano con rivestimento sfoderabile. Disponibile con braccioli a scelta nella larghezza 4 cm e 16 cm e con cucitura pizzicata. Imbottitura seduta in espanso indeformabile a quote differenziate, rivestito in falda di dacron accoppiato con tela di cotone.
 Letto a scomparsa con apertura abbattibile e dispositivo di sicurezza che impedisce aperture e chiusure accidentali.
 Meccanismo di articolazione con molle a gas e dispositivo di movimento ammortizzato, totalmente incassato nel fianco del mobile mediante tecnologia brevettata e speciale lavorazione.

Kali with a horizontal single or intermediate (90 and 120 cm) bed with the CF09 bed base and sofa, both patented, which transforms into the night-time version with a simple movement: the backrest cushions are removed and as the lower bed is opened, the sofa tilts backwards and slots in underneath the bed. Sofa with removable covers.
 Available with a choice of armrests 4 cm or 16 cm wide and with French stitching. Seat padding made of graduated non-deformable foam covered with dacron bonded with cotton cloth.
 Foldaway bed with a fold-down opening mechanism and safety device that prevents accidental opening and closing. Tilting mechanism with gas springs and device that cushions movements, completely contained in the side of the structure, thanks to patented technology and special manufacturing.



Ambiente 09

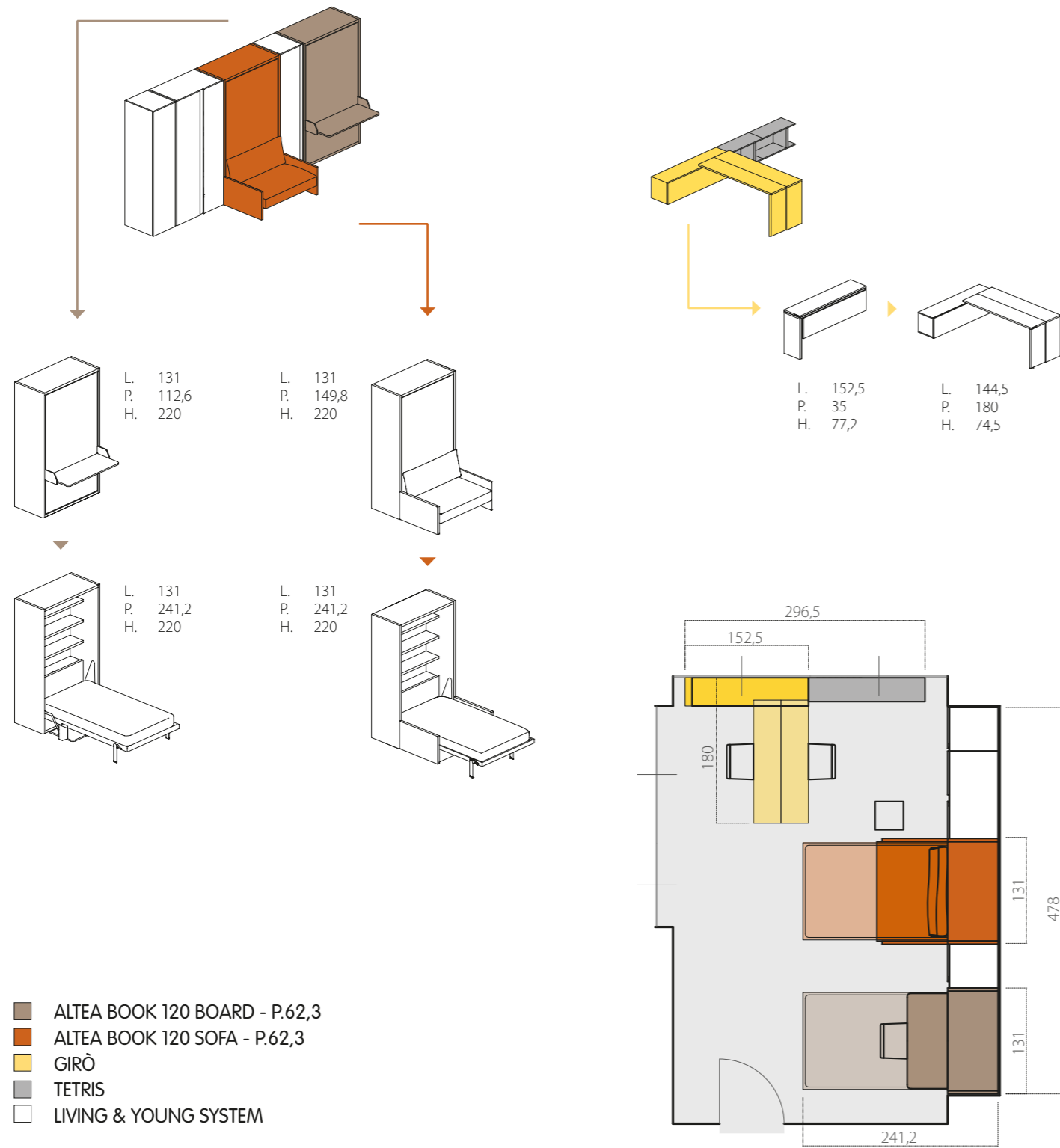

ALTEA BOOK 120 BOARD - P.62,3

Rete CF09.
protetta da brevetto
patent protected

Board.
protetto da brevetto
patent protected

ALTEA BOOK 120 SOFA - P.62,3

Rete CF09.
protetta da brevetto
patent protected

Sofa.
protetto da brevetto
patent protected

Nelle immagini:
un grande ambiente
multifunzionale con Altea Book
120 Sofa - P.62,3 e Altea Book
120 Board - P.62,3 integrati nei
programmi Living & Young
System, e tavolo Girò con
elementi pensili giorno Tetris.

Pictured:
a large multi-functional room
with the Altea Book 120
Sofa - P.62,3 and Altea Book
120 Board - P.62,3 integrated
in the Living & Young System
programs and the Girò table
with Tetris wall units.







ALTEA BOOK BOARD - P.62,3

Mobile trasformabile con letto singolo o intermedio, con rete a doghe CF09 e con scrittoio maxi, entrambi brevettati. Letto con apertura abbattibile e dotato del dispositivo di sicurezza che impedisce aperture e chiusure accidentali. Meccanismo di articolazione con molle a gas e dispositivo di movimento ammortizzato, totalmente incassato nel fianco del mobile mediante tecnologia brevettata e speciale lavorazione. Il sistema trasformabile con un semplice movimento si trasforma nella versione notte senza rimuovere nulla dal grande piano scrittoio che bascula e si posiziona orizzontalmente sotto al letto. Il modello realizzato nella profondità 35 cm (con testata letto tessile) e 62,3 cm (con testata letto in legno, contenitore porta guanciali e mensole) si articola nelle versioni Standard, Board (scrittoio maxi), Work (tavolo), Sofa.

Transforming system with single or intermediate bed, with CF09 slatted bed base and large desk, which are both patented. The bed features a fold-down opening mechanism and safety device that prevents accidental opening and closing. Tilting mechanism with gas springs and device that cushions movements, completely contained in the side of the structure, thanks to patented technology and special manufacturing. With a simple movement, the system transforms into the night-time version without the need to remove anything from the large desk that tilts and slots in horizontally underneath the bed. The model is produced with depth 35 cm (with fabric headboard) and 62,3 cm (with wooden headboard, pillow compartment and shelves) and it is available in the Standard, Board (large desk), Work (table), Sofa versions.

Scrittoio/Desk
cm L 118,1 x P 50,3 x H 72
Mobile Letto chiuso/Plain System with closed bed
cm L 131 x P 62,3 x H 220
Mobile Letto chiuso + Scrittoio/
Plain System with closed bed + Desk
cm L 131 x P 112,6 x H 220
—
Mobile Letto aperto/System with open bed
cm L 131 x P 241,2 x H 220
Mensole + Testata/Bookshelf + Headboard
cm L 123 x P 28,7 x H 210,7





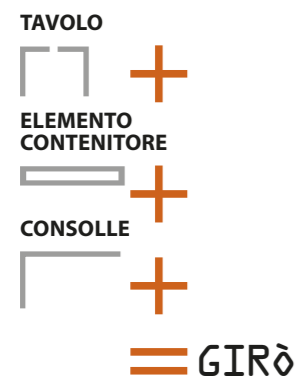

GIRÒ

Tavolo/consolle con meccanismo rotante e apertura a libro. Il sistema vincolato e sovrapposto all'elemento contenitore (L 144,5 cm x P 35 cm x H 18 cm con cassetti e H 36 cm con anta a ribalta) si trasforma in un tavolo. Il sistema tavolo/consolle è composto da due piani con apertura a libro, con gamba di supporto e meccanismo rotante.

Table/console table with rotating mechanism and bifold opening system. The system is fixed to and fits over the compartment section (W 144,5 cm x D 35 cm x H 18 cm with drawers and H 36 cm with flip-down door) and becomes a table. The table/console table system is composed of two bifolding tops, with supporting leg and rotating mechanism.

Chiuso/Closed (total)
cm L 152,5 x P 35 x H 77,2

Aperto/Open (total)
cm L 144,5 x P 180 x H 74,5

Tavolo/Table
cm L 68 x P 152,5 x H 74,5



ALTEA BOOK SOFA - P.62,3

ALTEA BOOK 120 SOFA - P.62,3

Altea Book è un mobile trasformabile con letto singolo o intermedio, rete a doghe CF09 e con divano, entrambi brevettati. Letto con apertura abbattibile e dotato del dispositivo di sicurezza che impedisce aperture e chiusure accidentali. Meccanismo di articolazione con molle a gas e dispositivo di movimento ammortizzato, totalmente incassato nel fianco del mobile mediante tecnologia brevettata e speciale lavorazione.

Altea Book nella versione Sofa: all'apertura del letto, rimuovendo i cuscini di schienale, il divano con struttura basculante arretra e con movimento traslatorio si posiziona sotto il letto. Il divano è disponibile con due tipi di braccioli di misure diverse (L 4 cm e 16 cm).

Imbottitura seduta in espanso indeformabile a quote differenziate rivestito in falda di dacron accoppiata con tela di cotone. Schienali imbottiti in piumafill rivestiti con tela di cotone. Rivestimento sfoderabile con cucitura pizzicata.

Il modello realizzato nella profondità 35 cm (con testata letto tessile) e 62,3 cm (con testata letto in legno, contenitore porta guanciali e mensole) si articola nelle versioni Standard, Work (tavolo), Board (scrittoio maxi), Sofa.

Altea Book is a transforming system with single or intermediate bed, with a CF09 slatted bed base and sofa, which are both patented.

The bed features a fold-down opening mechanism and safety device that prevents accidental opening and closing.

Tilting mechanism with gas springs and device that cushions movements, completely contained in the side of the structure, thanks to patented technology and special manufacturing.

Altea Book in the Sofa version: the backrest cushions are removed and as the bed is opened, the sofa tilts backwards and slots in underneath the bed.

The sofa is available with two types of armrest in different sizes (W 4 cm and 16 cm).

Seat padding made of graduated non-deformable foam covered with dacron bonded with cotton cloth. The backrests are padded with piumafill and upholstered with cotton cloth. Removable covers with French stitching.

The model is produced with depth 35 cm (with fabric headboard) and 62,3 cm (with wooden headboard, pillow compartment and shelves) and it is available in the Standard, Work (table), Board (large desk), Sofa versions.



Divano braccioli L cm 4/Sofa with armrests cm 4 wide
cm L 131 x P 87,5 x H 80

Mobile Letto chiuso/Plain System with closed bed
cm L 131 x P 62,3 x H 220

Mobile Letto chiuso + Divano/
Plain System with closed bed + Sofa
cm L 131 x P 149,8 x H 220

Mobile Letto aperto/System with open bed
cm L 131 x P 241,2 x H 220

Mensole + Testata/Bookshelf + Headboard
cm L 123 x P 28,7 x H 210,7



Ambiente 10

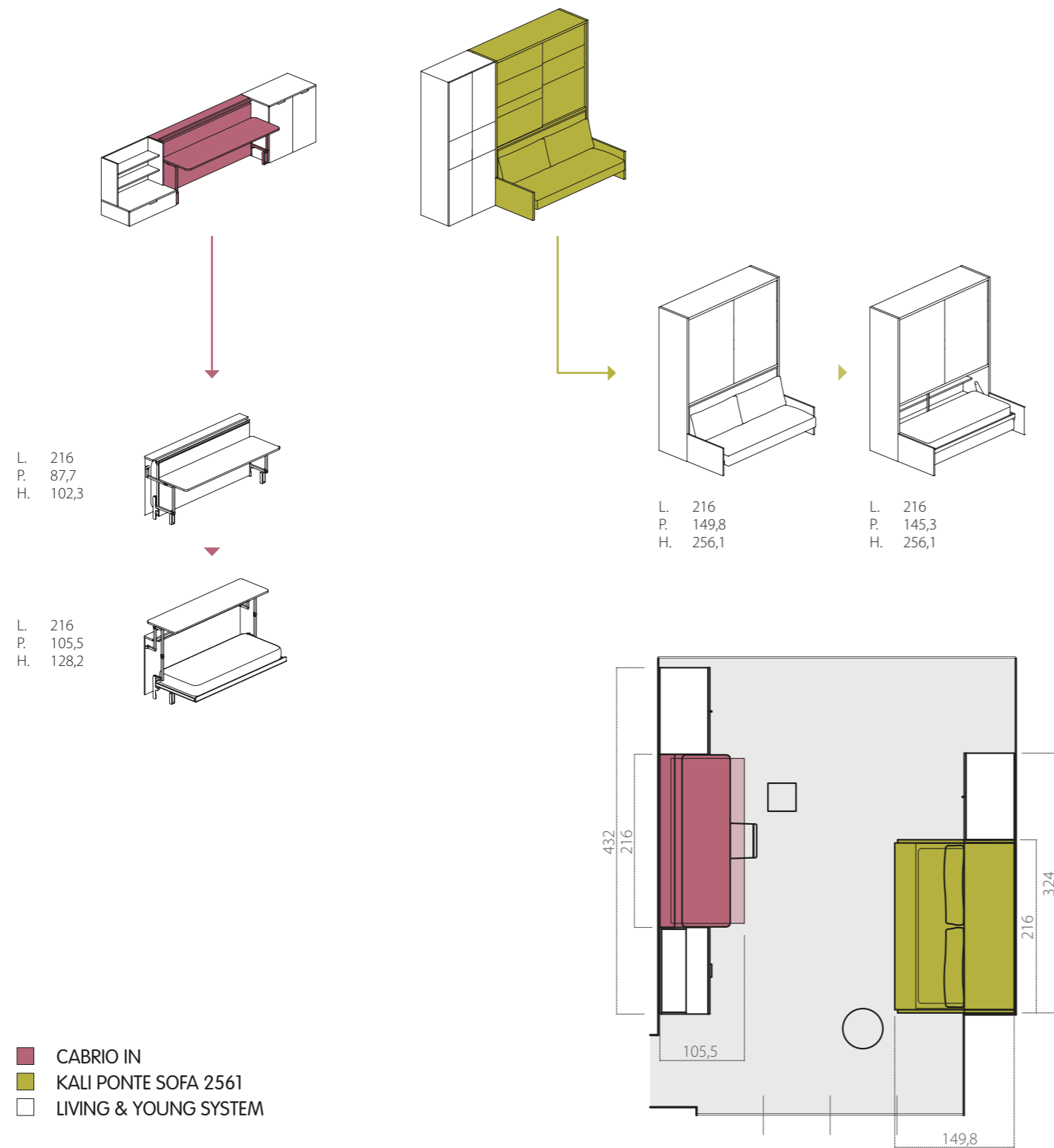

CABRIO IN
 protetto da brevetto
 patent protected

KALI PONTE SOFA 2561

Rete CF09.
 protetta da brevetto
 patent protected

Sofa.
 protetto da brevetto
 patent protected

Nelle immagini:
 un ambiente di design con
 sistema Cabrio In, coordinato
 con elementi giorno, e libreria,
 contenitore e con mobile
 trasformabile Kali Ponte Sofa.

Pictured:
 a designer room with Cabrio In,
 system coordinated with
 bookcase and storage
 elements and the transforming
 Kali Ponte Sofa.





CABRIO IN

Sistema trasformabile per zona studio/lavoro integrabile nei programmi Living & Young System.

Il sistema coniuga uno scrittoio elevabile di grandi dimensioni con un letto singolo. Con un semplice movimento si trasforma nella versione notte senza dover rimuovere nulla dal piano scrittoio.

Il mobile si completa con elementi base e pensili con ante e a giorno, accostabili e disponibili in varie dimensioni.

Transforming system for studying/working purposes, it can be integrated into the Living & Young System modular programs.

The system is composed of a wide lifting up writing desk and a single bed.

By a simple movement it transforms into the night configuration without removing any objects from the top.

The system is completed by floor cabinets wall units either with or without door, which can be combined and are available in various sizes.

Scrittoio/Desk
cm L 214,6 x P 60 x H 73
Mobile Letto chiuso/System with closed bed
cm L 216 x P 27/62,3 x H 102,3
Mobile Letto chiuso + Scrittoio/
System with closed bed + Desk
cm L 216 x P 87,7 x H 102,3

—
Mobile Letto aperto/System with open bed
cm L 216 x P 105,5 x H 128,2



== CABRIO IN

Nelle immagini:
elemento contenitore chiuso e libreria con cassetto accostati al sistema trasformabile Cabrio In.

Pictured:
closed container element and bookcase with drawer combined with the transformable Cabrio In system.





KALI PONTE SOFA 256,1

Sistema componibile trasformabile con letto singolo orizzontale a scomparsa, con rete a doghe brevettata CF09, testata reclinabile e divano brevettato integrato con elemento armadio ponte, ad ante scorrevoli, disponibile nelle altezze cm 220 e 256,1.

Sistema con apertura abbattibile e dotato del dispositivo di sicurezza che impedisce aperture e chiusure accidentali.

Meccanismo di articolazione con molle a gas e dispositivo di movimento ammortizzato, totalmente incassato nel fianco del mobile mediante tecnologia brevettata e speciale lavorazione.

Kali Ponte Sofa si trasforma nella versione notte: rimuovendo i cuscini di schienale, con l'apertura del letto inferiore, il divano con struttura basculante arretra e con movimento traslatorio si posiziona sotto al letto.

Il divano è disponibile con due tipi di braccioli di misure diverse (L 4 cm e 16 cm).

Imbottitura seduta in espanso indeformabile a quote differenziate rivestito in falda di dacron accoppiata con tela di cotone. Schienali imbottiti in piumafill rivestiti con tela di cotone. Rivestimento sfoderabile con cucitura pizzicata.

Transforming modular system with a foldaway horizontal single bed with the patented CF09 bed base, reclining headboard and patented sofa integrated with the bridge wardrobe element with sliding doors, available 220 and 256,1 cm high.

The system features a fold-down opening mechanism and safety device that prevents accidental opening and closing.

Tilting mechanism with gas springs and device that cushions movements, completely contained in the side of the structure, thanks to patented technology and special manufacturing.

Kali Ponte Sofa transforms into the night-time version: the backrest cushions are removed and as the lower bed is opened, the sofa tilts backwards and slots in underneath the bed.

The sofa is available with two types of armrest in different sizes (W 4 cm and 16 cm).

Seat padding made of graduated non-deformable foam covered with dacron bonded with cotton cloth.

The backrests are padded with piumafill and upholstered with cotton cloth.

Removable covers with French stitching.

Nell'immagine:
dettaglio Kali Ponte Sofa: apertura del letto e divano che bascula e si posiziona sotto.

Pictured:
Kali Ponte Sofa detail: when the bed is opened, the sofa tilts back and slots into it.



Divano braccioli L cm 4/Sofa with armrests cm 4 wide
cm L 216 x P 87,5 x H 80

Mobile Letto chiuso/Plain System with closed bed
cm L 216 x P 62,3 x H 256,1

Mobile Letto chiuso + Divano/Plain System with closed bed + Sofa
cm L 216 x P 149,8 x H 256,1

—
Mobile Letto aperto/System with open bed
cm L 216 x P 145,3 x H 256,1

Mensola/Bookshelf
cm L 208 x P 19,4 x H 93

LETTO +



DIVANO +



ARMADIO +



— KALI PONTE
SOFA

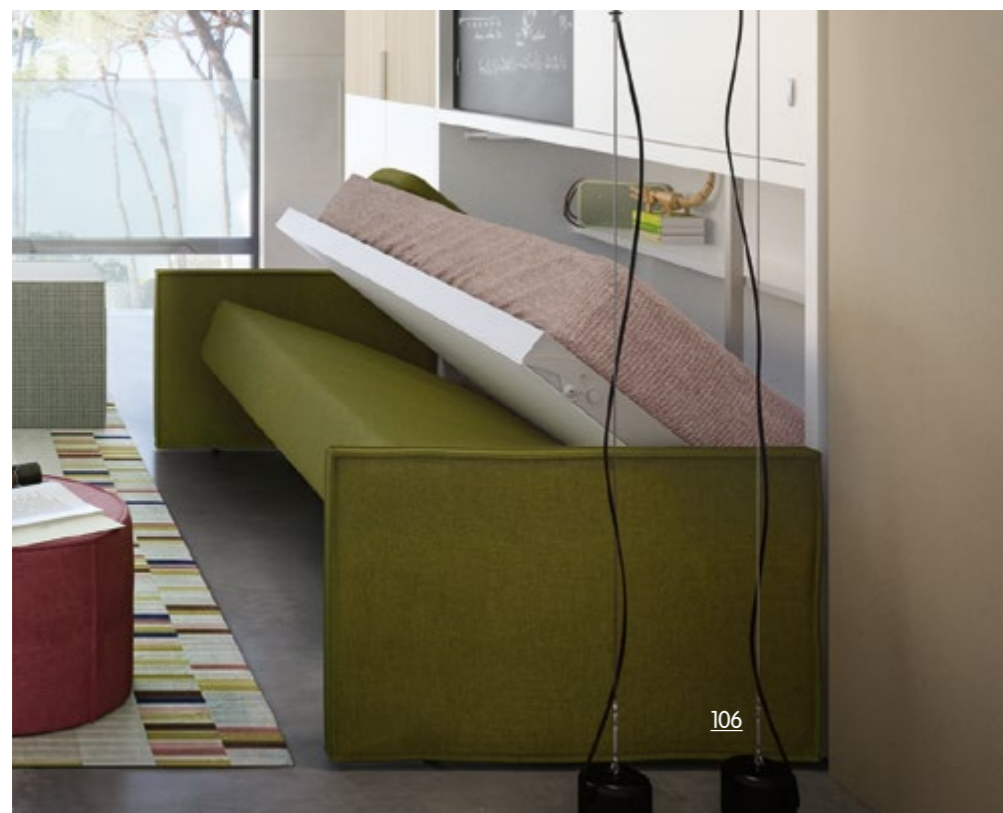

Ambiente 11

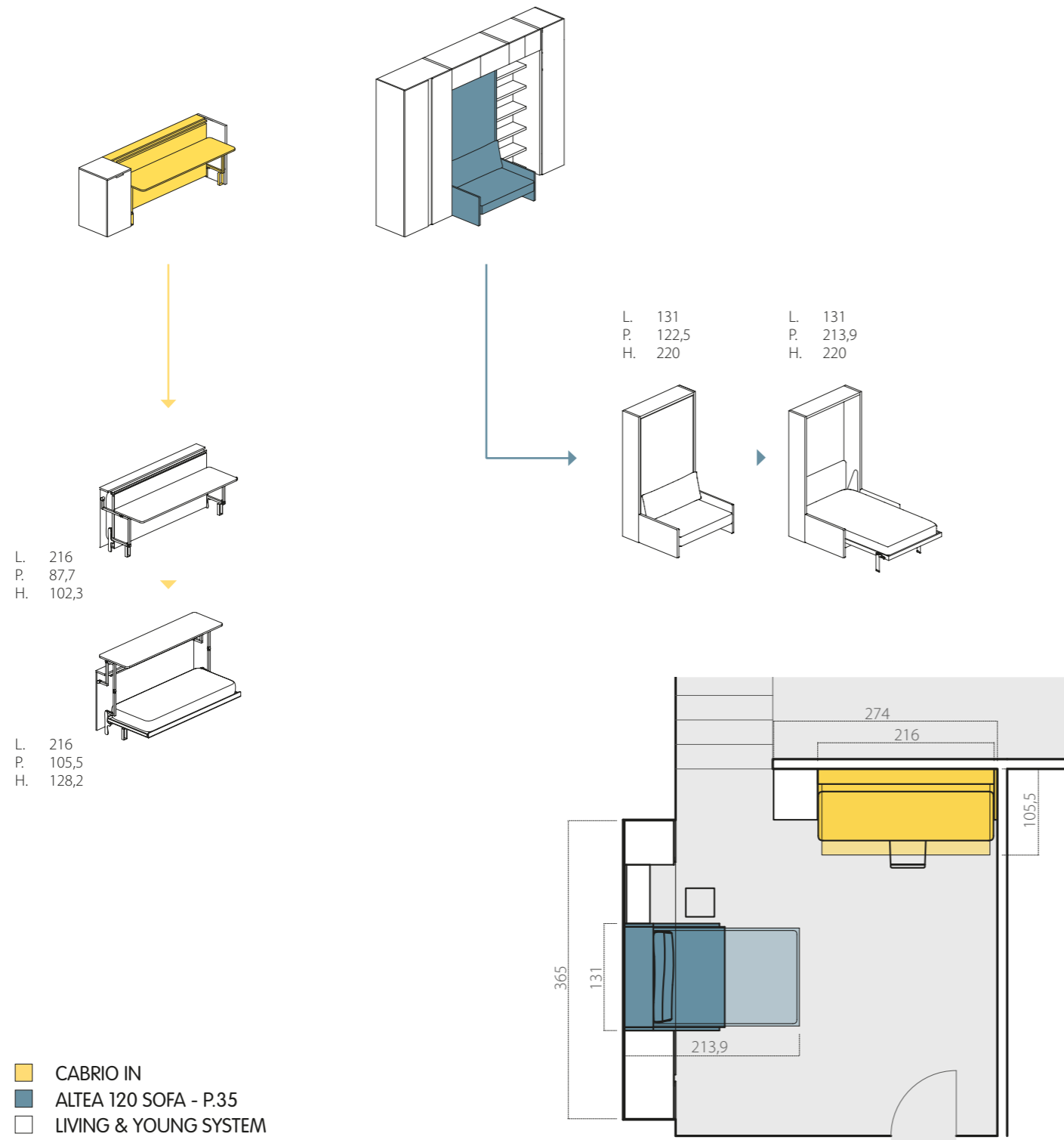

CABRIO IN
 protetto da brevetto
 patent protected

ALTEA 120 SOFA - P.35

Rete CF09.
 protetta da brevetto
 patent protected

Sofa.
 protetto da brevetto
 patent protected

Nelle immagini:
 Altea 120 Sofa - P.35 integrato
 nel mobile a parete e sistema
 Cabrio In in un ambiente
 dinamico, multifunzionale, per
 riposo, relax, studio/lavoro e
 contenimento.

Pictured:
 Altea 120 Sofa - P.35
 is integrated in a wall
 composition and Cabrio In
 system in a dynamic, multi-
 functional room for rest,
 relaxation, studying/working
 and storage.









CABRIO IN

Sistema trasformabile per zona studio/lavoro integrabile nei programmi Living & Young System.

Il sistema coniuga uno scrittoio elevabile di grandi dimensioni con un letto singolo. Con un semplice movimento si trasforma nella versione notte senza dover rimuovere nulla dal piano scrittoio.

Il mobile si completa con elementi base e pensili con ante e a giorno, accostabili e disponibili in varie dimensioni.

Transforming system for studying/working purposes, it can be integrated into the Living & Young System modular programs.

The system is composed of a wide lifting up writing desk and a single bed.

By a simple movement it transforms into the night configuration without removing any objects from the top.

The system is completed by floor cabinets wall units either with or without door, which can be combined and are available in various sizes.

Scrittoio/Desk

cm L 214,6 x P 60 x H 73

Mobile Letto chiuso/System with closed bed

cm L 216 x P 27/62,3 x H 102,3

Mobile Letto chiuso + Scrittoio/

System with closed bed + Desk

cm L 216 x P 87,7 x H 102,3

—

Mobile Letto aperto/System with open bed

cm L 216 x P 105,5 x H 128,2





ALTEA 120 SOFA - P.35

Altea 120 Sofa - P.35 è un sistema trasformabile a doppia funzione con letto intermedio a scomparsa, disponibile anche con letto singolo, con rete a doghe brevettata CF09 e con divano brevettato che con un semplice movimento si trasforma nella versione notte: rimuovendo i cuscini di schienale all'apertura del letto, il divano, con struttura basculante arretra e con movimento traslatorio si posiziona sotto al letto. Sistema con apertura abbattibile e dotato del dispositivo di sicurezza che impedisce aperture e chiusure accidentali. Meccanismo di articolazione con molle a gas e dispositivo di movimento ammortizzato, totalmente incassato nel fianco del mobile mediante tecnologia brevettata e speciale lavorazione. Divano con imbottitura della seduta in espanso indeformabile a quote differenziate rivestito in falda di dacron accoppiata con tela di cotone. Schienali imbottiti in piumafill rivestiti con tela di cotone. Rivestimento sfoderabile con cucitura pizzicata. Disponibile con due tipi di braccioli di misure diverse (L 4 cm e 16 cm).

Altea 120 Sofa - P.35 is a dual-function transforming system with a foldaway intermediate bed, also available with a single bed, with the patented CF09 slatted bed base and patented sofa, which transforms into the night-time version with a simple movement: the backrest cushions are removed and as the bed is opened, the sofa tilts backwards and slots in underneath the bed. The system features a fold-down opening mechanism and safety device that prevents accidental opening and closing. Tilting mechanism with gas springs and device that cushions movements, completely contained in the side of the structure, thanks to patented technology and special manufacturing. The sofa features seat padding made of graduated non-deformable foam upholstered with dacron bonded with cotton cloth. The backrests are padded with piumafill and upholstered with cotton cloth. Removable covers with French stitching. Available with two types of armrest in different sizes (W 4 cm and 16 cm).

Divano braccioli L cm 4/Sofa with armrests cm 4 wide
cm L 131 x P 87,5 x H 80

Mobile Letto chiuso/Plain System with closed bed
cm L 131 x P 35 x H 220

Mobile Letto chiuso + Divano/Plain System with closed bed + Sofa
cm L 131 x P 122,5 x H 220

—
Mobile Letto aperto/System with open bed
cm L 131 x P 213,9 x H 220



ALTEA SOFA - P.35



Wally

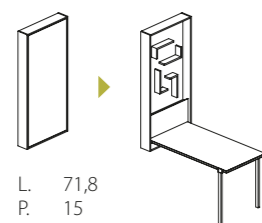

L. 71,8
P. 15
H. 153,5

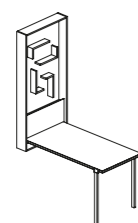

L. 71,8
P. 152
H. 213,5
Tavolo/Table
H. 74

WALLY presentazione tecnica technical presentation

Elemento contenitore attrezzato, con tavolo integrato con apertura a ribalta.

Con un semplice movimento le gambe in metallo riposte lateralmente al piano si sganciano e si autobloccano nella posizione di servizio.

Realizzato in melaminico bianco e laccato, nelle versioni con schienale attrezzato con 2 mensole o con schienale magnetico con 4 mensole organizzabili.

In una situazione spazio giovani funge anche da scrittoio.

Case element equipped with integrated table with tilting opening.

Through a simple movement, the metal legs placed on the side of the top are released, and they self-lock in the operating position.

Available in melamine white and lacquered finish in the configuration with back panel equipped with 2 shelves or with magnetic back panel with 4 movable shelves.

In a children's room, it is a writing desk as well.

Chiuso/Closed (total)
cm L 71,8 x P 15 x H 153,5/213,5 (da terra/from floor)

—
Aperto/Open (total)
cm L 71,8 x P 152 x H 213,5/213,5 (da terra/from floor)
Tavolo/Table
cm L 67,4 x P 140 x H 74



LACCATURE, ESSENZE, MELAMINICI, DIALUX, VETRI,
STAMPE, TESSUTI...

LACQUERS, WOOD VENEERS, MELAMINES, DIALUX,
GLASSES, DECORATIONS, FABRICS...



CLEI COLOUR SYSTEM: TOTALE LIBERTÀ DI SCELTA/ TOTAL FREEDOM OF CHOICE

Liberi di scegliere nella vasta gamma dei campionari dei materiali, finiture e tessuti per progettare e personalizzare l'ambiente domestico con molteplici combinazioni di toni e materiali.

You are free to choose from the vast range of samples of materials, finishes and fabrics to design and personalise your home environment with multiple combinations of tones and materials.

I campioni di colori e materiali hanno valore indicativo.
The color and material samples are purely indicative.

TEC - HNIC - CAL - FILES

SCHEDE TECNICHE

TECHNICAL FILES

In queste pagine una panoramica sintetica dei diversi modelli che compongono le varie famiglie dei prodotti.
La gamma completa dei programmi Living & Young System con le caratteristiche tecniche dettagliate dei prodotti e delle loro possibilità di combinazione sono rappresentate sul listino di vendita.

These pages provide a brief overview of the different models that make up the various product families.
The complete Living & Young System range with detailed technical characteristics of the products and their possible combinations is outlined in the sales list.

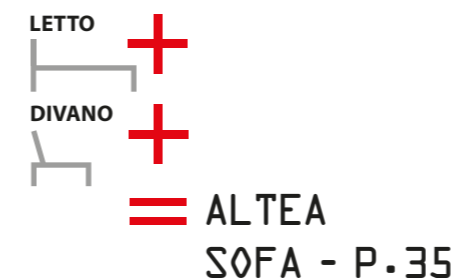

ALTEA 120 SOFA - P.35

Altea 120 Sofa - P.35 è un sistema trasformabile a doppia funzione con letto intermedio a scomparsa, disponibile anche con letto singolo, con rete a doghe brevettata CF09 e con divano brevettato che con un semplice movimento si trasforma nella versione notte: rimuovendo i cuscini di schienale all'apertura del letto, il divano, con struttura basculante arretra e con movimento traslatorio si posiziona sotto al letto. Sistema con apertura abbattibile e dotato del dispositivo di sicurezza che impedisce aperture e chiusure accidentali. Meccanismo di articolazione con molle a gas e dispositivo di movimento ammortizzato, totalmente incassato nel fianco del mobile mediante tecnologia brevettata e speciale lavorazione. Divano con imbottitura della seduta in espanso indeformabile a quote differenziate rivestito in falda di dacron accoppiata con tela di cotone. Schienali imbottiti in piumafill rivestiti con tela di cotone. Rivestimento sfoderabile con cucitura pizzicata. Disponibile con due tipi di braccioli di misure diverse (L 4 cm e 16 cm).

Altea 120 Sofa - P.35 is a dual-function transforming system with a foldaway intermediate bed, also available with a single bed, with the patented CF09 slatted bed base and patented sofa, which transforms into the night-time version with a simple movement: the backrest cushions are removed and as the bed is opened, the sofa tilts backwards and slots in underneath the bed. The system features a fold-down opening mechanism and safety device that prevents accidental opening and closing. Tilting mechanism with gas springs and device that cushions movements, completely contained in the side of the structure, thanks to patented technology and special manufacturing. The sofa features seat padding made of graduated non-deformable foam upholstered with dacron bonded with cotton cloth. The backrests are padded with piumafill and upholstered with cotton cloth. Removable covers with French stitching. Available with two types of armrest in different sizes (W 4 cm and 16 cm).



Rete CF09.
protetta da brevetto
patent protected

Sofa.
protetto da brevetto
patent protected





LETTO +

TESTATA
ATTREZZATA



**ALTEA BOOK
STANDARD - P.62,3**



Rete CF09.
protetta da brevetto
patent protected

ALTEA BOOK 90 STANDARD - P.62,3

Mobile trasformabile con letto singolo o intermedio a scomparsa, rete a doghe brevettata CF09, con apertura abbattibile e dispositivo di sicurezza che impedisce aperture e chiusure accidentali.

Meccanismo di articolazione con molle a gas e dispositivo di movimento ammortizzato, totalmente incassato nel fianco del mobile mediante tecnologia brevettata e speciale lavorazione.

Il modello è realizzato nelle profondità 35 cm (con testata letto tessile) e 62,3 cm (con testata letto in legno, contenitore porta guanciali e mensola) e si articola nelle versioni Standard, Work (tavolo), Board (scrivitoio maxi), Sofa.

Transforming system with a foldaway single or intermediate bed, patented CF09 slatted bed base, with a fold-down opening mechanism and safety device that prevents accidental opening and closing. Tilting mechanism with gas springs and device that cushions movements, completely contained in the side of the structure, thanks to patented technology and special manufacturing.

The model is produced with depth 35 cm (with fabric headboard) and 62,3 cm (with wooden headboard, pillow compartment and shelves) and it is available in the Standard, Work (table), Board (large desk), Sofa versions.



LETTO +

TESTATA
ATTREZZATA



**ALTEA BOOK
WORK - P.62,3**

TAVOLO +

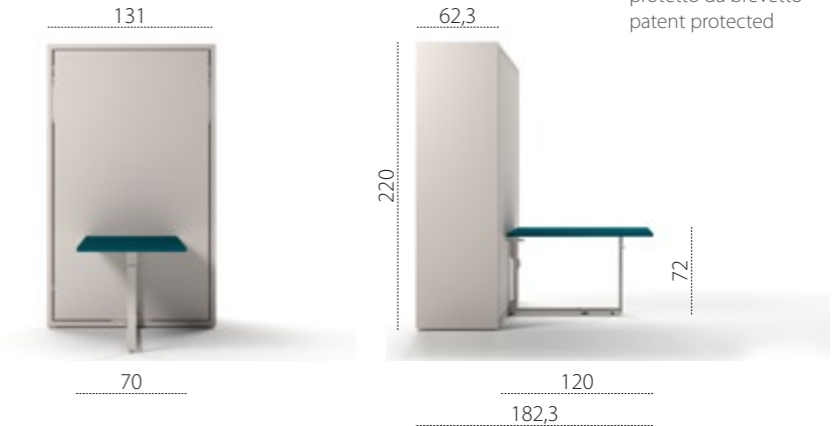

Rete CF09.
protetta da brevetto
patent protected

Work.
protetto da brevetto
patent protected

ALTEA BOOK 120 WORK - P.62,3

Altea Book 120 Work è un sistema trasformabile a doppia funzione con letto intermedio a scomparsa, disponibile anche con letto singolo, con rete a doghe CF09 e tavolo Work, entrambi brevettati.

Letto con apertura abbattibile e dotato del dispositivo di sicurezza che impedisce aperture e chiusure accidentali e meccanismo di articolazione con molle a gas e dispositivo di movimento ammortizzato, totalmente incassato nel fianco del mobile mediante tecnologia brevettata e speciale lavorazione.

Il modello realizzato nella profondità 35 cm (con testata letto tessile) e 62,3 cm (con testata letto in legno, contenitore porta guanciali e mensole) si articola nelle versioni Standard, Work (tavolo), Board (scrivitoio maxi), Sofa.

Altea Book 120, nella versione Work, è caratterizzato da un tavolo meccanizzato (L 70 cm x P 120 cm x H 72 cm) per specifiche funzioni: apertura abbattibile per la funzione tavolo, chiusura verticale parallela alla facciata del mobile per ridurre l'ingombro, e movimento basculante per posizionamento sotto alla rete del letto nella versione notte.

Altea Book 120 Work is a dual-function transforming system with a foldaway intermediate bed, also available with a single bed, with the CF09 slatted bed base and Work table, which are both patented. Bed with a fold-down opening mechanism, safety device that prevents accidental opening and closing and tilting mechanism with gas springs and device that cushions movements, completely contained in the side of the structure, thanks to patented technology and special manufacturing.

The model is produced with depth 35 cm (with fabric headboard) and 62,3 cm (with wooden headboard, pillow compartment and shelves) and it is available in the Standard, Work (table), Board (large desk), Sofa versions.

In the Work version, Altea Book 120 features a mechanised table (W 70 cm x D 120 cm x H 72 cm) for specific functions: fold-down opening for the table function, vertical closing flush to front of the system to free up space and tilting movement so that it slots in underneath the bed base in the night-time position.





LETTO +

TESTATA
ATTREZZATA +



SCRITTOIO +



ALTEA BOOK BOARD - P.62-3

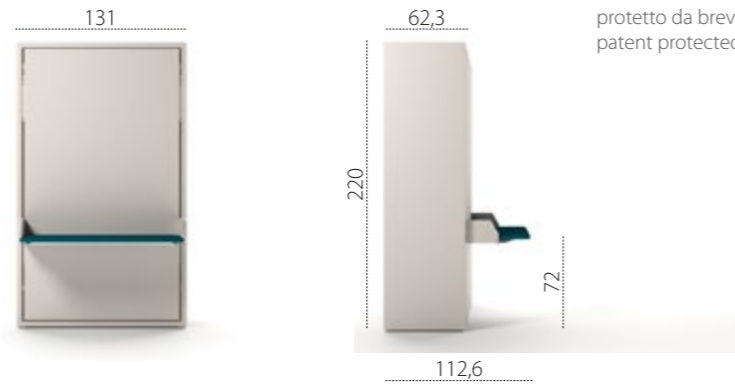

Rete CF09.
protetta da brevetto
patent protected

Board.
protetto da brevetto
patent protected

ALTEA BOOK 120 BOARD - P.62-3

Mobile trasformabile con letto singolo o intermedio, con rete a doghe CF09 e con scrittoio maxi, entrambi brevettati. Letto con apertura abbattibile e dotato del dispositivo di sicurezza che impedisce aperture e chiusure accidentali. Meccanismo di articolazione con molle a gas e dispositivo di movimento ammortizzato, totalmente incassato nel fianco del mobile mediante tecnologia brevettata e speciale lavorazione. Il sistema trasformabile con un semplice movimento si trasforma nella versione notte senza rimuovere nulla dal grande piano scrittoio che bascula e si posiziona orizzontalmente sotto al letto. Il modello realizzato nella profondità 35 cm (con testata letto tessile) e 62,3 cm (con testata letto in legno, contenitore porta guanciali e mensole) si articola nelle versioni Standard, Board (scrittoio maxi), Work (tavolo), Sofa.

Transforming system with single or intermediate bed, with CF09 slatted bed base and large desk, which are both patented.

The bed features a fold-down opening mechanism and safety device that prevents accidental opening and closing.

Tilting mechanism with gas springs and device that cushions movements, completely contained in the side of the structure, thanks to patented technology and special manufacturing.

With a simple movement, the system transforms into the night-time version without the need to remove anything from the large desk that tilts and slots in horizontally underneath the bed.

The model is produced with depth 35 cm (with fabric headboard) and 62,3 cm (with wooden headboard, pillow compartment and shelves) and it is available in the Standard, Board (large desk), Work (table), Sofa versions.



LETTO +

TESTATA
ATTREZZATA +

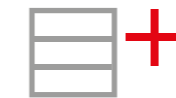

DIVANO +



ALTEA BOOK SOFA - P.62-3

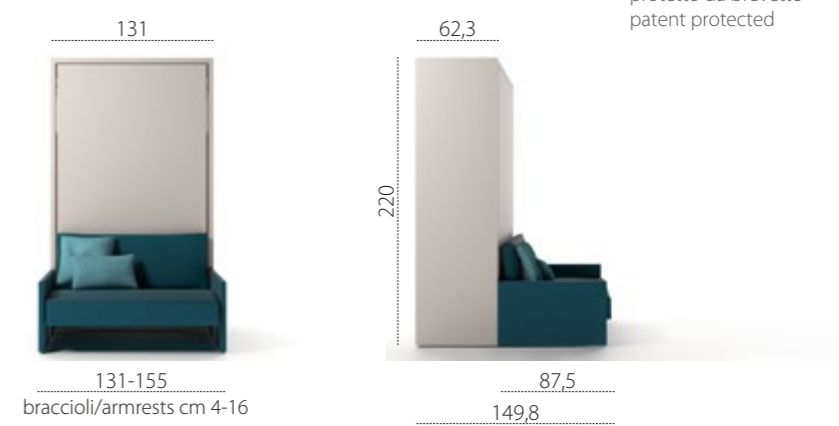

Rete CF09.
protetta da brevetto
patent protected

Sofa.
protetto da brevetto
patent protected

ALTEA BOOK 120 SOFA - P.62-3

Altea Book è un mobile trasformabile con letto singolo o intermedio, rete a doghe CF09 e con divano, entrambi brevettati. Letto con apertura abbattibile e dotato del dispositivo di sicurezza che impedisce aperture e chiusure accidentali. Meccanismo di articolazione con molle a gas e dispositivo di movimento ammortizzato, totalmente incassato nel fianco del mobile mediante tecnologia brevettata e speciale lavorazione.

Altea Book nella versione Sofa: all'apertura del letto, rimuovendo i cuscini di schienale, il divano con struttura basculante arretra e con movimento traslatorio si posiziona sotto il letto.

Il divano è disponibile con due tipi di braccioli di misure diverse (L 4 cm e 16 cm).

Imbottitura seduta in espanso indeformabile a quote differenziate rivestito in falda di dacron accoppiata con tela di cotone. Schienali imbottiti in piumafill rivestiti con tela di cotone.

Rivestimento sfoderabile con cucitura pizzicata. Il modello realizzato nella profondità 35 cm (con testata letto tessile) e 62,3 cm (con testata letto in legno, contenitore porta guanciali e mensole) si articola nelle versioni Standard, Work (tavolo), Board (scrittoio maxi), Sofa.

Altea Book is a transforming system with single or intermediate bed, with a CF09 slatted bed base and sofa, which are both patented.

The bed features a fold-down opening mechanism and safety device that prevents accidental opening and closing.

Tilting mechanism with gas springs and device that cushions movements, completely contained in the side of the structure, thanks to patented technology and special manufacturing.

Altea Book in the Sofa version: the backrest cushions are removed and as the bed is opened, the sofa tilts backwards and slots in underneath the bed.

The sofa is available with two types of armrest in different sizes (W 4 cm and 16 cm).

Seat padding made of graduated non-deformable foam covered with dacron bonded with cotton cloth. The backrests are padded with piumafill and upholstered with cotton cloth.

Removable covers with French stitching. The model is produced with depth 35 cm (with fabric headboard) and 62,3 cm (with wooden headboard, pillow compartment and shelves) and it is available in the Standard, Work (table), Board (large desk), Sofa versions.



LETTO
A SCOMPARSA

 KALI
STANDARD

Rete CF09.
protetta da brevetto
patent protected



KALI STANDARD 90

Sistema trasformabile Kali in versione Standard: letto orizzontale singolo (90 cm) o intermedio (120 cm) con rete a doghe brevettata CF09 e testata tessile reclinabile, con apertura abbattibile e dotato del dispositivo di sicurezza che impedisce aperture e chiusure accidentali. Meccanismo di articolazione con molle a gas e dispositivo di movimento ammortizzato, totalmente incassato nel fianco del mobile mediante tecnologia brevettata e speciale lavorazione.

Kali transforming system in the Standard version: horizontal single (90 cm) or intermediate bed (120 cm) with patented CF09 slatted bed base and reclining fabric headboard, features a fold-down opening mechanism and safety device that prevents accidental opening and closing. Tilting mechanism with gas springs and device that cushions movements, completely contained in the side of the structure, thanks to patented technology and special manufacturing.



LETTO +
SCRITTOIO +
 KALI
BOARD

Rete CF09.
protetta da brevetto
patent protected

Board.
protetto da brevetto
patent protected

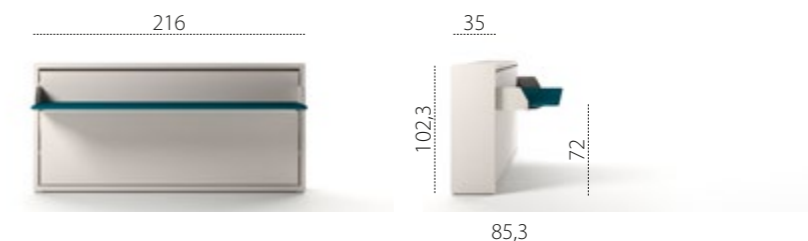

KALI BOARD 90

Sistema trasformabile Kali con letto singolo (90 cm) o intermedio (120 cm) a scomparsa, con rete a doghe brevettata CF09, testata tessile reclinabile e scrittoio maxi brevettato.

Sistema con apertura abbattibile e dotato del dispositivo di sicurezza che impedisce aperture e chiusure accidentali.

Meccanismo di articolazione con molle a gas e dispositivo di movimento ammortizzato, totalmente incassato nel fianco del mobile mediante tecnologia brevettata e speciale lavorazione.

Il sistema trasformabile con un semplice movimento si trasforma nella versione notte senza rimuovere nulla dal grande piano scrittoio che bascula e si posiziona orizzontalmente sotto al letto.

Il sistema trasformabile Kali si articola nelle versioni Standard (con letto orizzontale singolo 90 cm e intermedio 120 cm), Board (letto singolo o intermedio, con scrittoio), Sofa (letto singolo o intermedio, con divano).

Kali transforming system features a tilting single (90 cm) or intermediate (120 cm) bed, with patented CF09 slatted bed base, a reclining fabric headboard and a patented large desk.

The tilting opening system is fitted with a safety device preventing accidental opening and closing. Tilting mechanism through gas springs and device that cushions movements, completely contained in the side of the structure, thanks to patented technology and special manufacturing.

The system transforms into the night-time position in one simple movement, without the user having to remove anything from the desk which pivots and slots in horizontally underneath the bed.

Kali transforming system is available in the Standard (horizontal 90 cm single or 120 cm intermediate bed), Board (single or intermediate bed, with desk) and Sofa (single or intermediate bed, with sofa) versions.



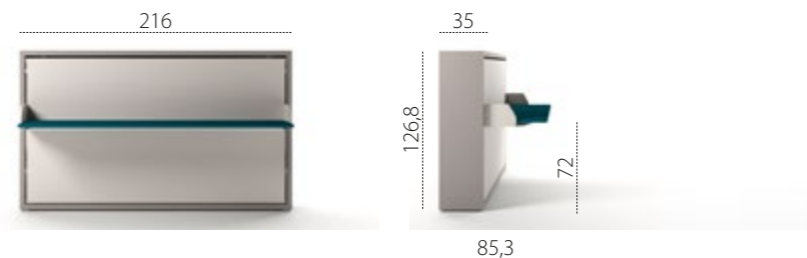
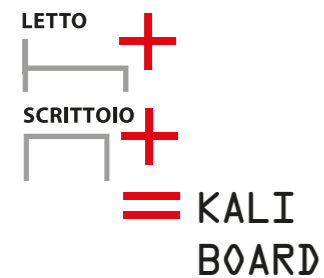

Rete CF09.
protetta da brevetto
patent protected

Board.
protetto da brevetto
patent protected

KALI BOARD 120

Sistema trasformabile Kali con letto singolo (90 cm) o intermedio (120 cm) a scomparsa, con rete a doghe brevettata CF09, testata tessile reclinabile e scrittoio maxi brevettato.

Sistema con apertura abbattibile e dotato del dispositivo di sicurezza che impedisce aperture e chiusure accidentali.

Meccanismo di articolazione con molle a gas e dispositivo di movimento ammortizzato, totalmente incassato nel fianco del mobile mediante tecnologia brevettata e speciale lavorazione.

Il sistema trasformabile con un semplice movimento si trasforma nella versione notte senza rimuovere nulla dal grande piano scrittoio che bascula e si posiziona orizzontalmente sotto al letto.

Il sistema trasformabile Kali si articola nelle versioni Standard (con letto orizzontale singolo 90 cm e intermedio 120 cm), Board (letto singolo o intermedio, con scrittoio), Sofa (letto singolo o intermedio, con divano).

Kali transforming system features a tilting single (90 cm) or intermediate (120 cm) bed, with patented CF09 slatted bed base, a reclining fabric headboard and a patented large desk.

The tilting opening system is fitted with a safety device preventing accidental opening and closing. Tilting mechanism through gas springs and device that cushions movements, completely contained in the side of the structure, thanks to patented technology and special manufacturing.

The system transforms into the night-time position in one simple movement, without the user having to remove anything from the desk which pivots and slots in horizontally underneath the bed.

Kali transforming system is available in the Standard (horizontal 90 cm single or 120 cm intermediate bed), Board (single or intermediate bed, with desk) and Sofa (single or intermediate bed, with sofa) versions.

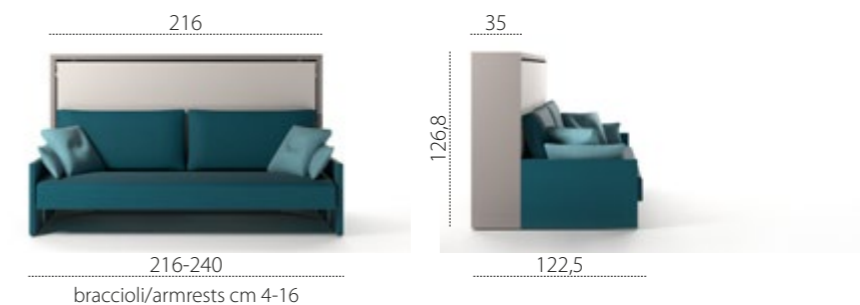
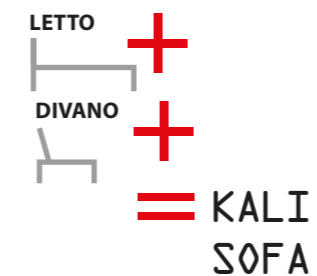

Rete CF09.
protetta da brevetto
patent protected

Sofa.
protetto da brevetto
patent protected

KALI SOFA 120

Kali con letto orizzontale singolo o intermedio (90 e 120 cm), con rete a doghe CF09 e divano, entrambi brevettati, che con un semplice movimento si trasforma nella versione notte: rimuovendo i cuscini di schienale, all'apertura del letto, il divano, con struttura basculante arretra e con movimento traslatorio si posiziona sotto il letto. Divano con rivestimento sfoderabile. Disponibile con braccioli a scelta nella larghezza 4 cm e 16 cm e con cucitura pizzicata. Imbottitura seduta in espanso indeformabile a quote differenziate, rivestito in falda di dacron accoppiato con tela di cotone.

Letto a scomparsa con apertura abbattibile e dispositivo di sicurezza che impedisce aperture e chiusure accidentali.

Meccanismo di articolazione con molle a gas e dispositivo di movimento ammortizzato, totalmente incassato nel fianco del mobile mediante tecnologia brevettata e speciale lavorazione.

Kali with a horizontal single or intermediate (90 and 120 cm) bed with the CF09 bed base and sofa, both patented, which transforms into the night-time version with a simple movement: the backrest cushions are removed and as the lower bed is opened, the sofa tilts backwards and slots in underneath the bed.

Sofa with removable covers. Available with a choice of armrests 4 cm wide and with French stitching. Seat padding made of graduated non-deformable foam covered with dacron bonded with cotton cloth. Foldaway bed with a fold-down opening mechanism and safety device that prevents accidental opening and closing.

Tilting mechanism with gas springs and device that cushions movements, completely contained in the side of the structure, thanks to patented technology and special manufacturing.



LETTO +
LETTO +
= **KALI DUO STANDARD**

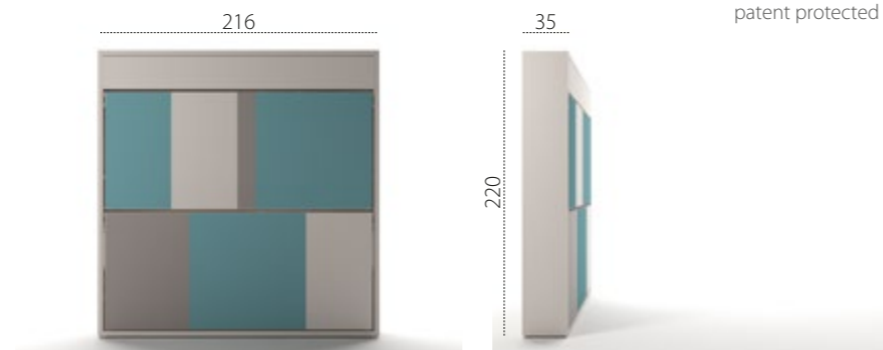

Rete CF09.
protetta da brevetto
patent protected

Kali Duo.
protetto da brevetto
patent protected

KALI DUO STANDARD 2200

Kali Duo in versione Standard con o senza elemento contenitore (H 220 cm e 194,3 cm) è un sistema trasformabile con letti a castello orizzontali a scomparsa, con rete a doghe brevettata CF09, apertura abbattibile e sistema di sicurezza per impedire aperture e chiusure accidentali. Il meccanismo di articolazione con molle a gas e dispositivo di movimento ammortizzato è totalmente incassato nel fianco del mobile, con tecnologia brevettata e speciale lavorazione. Il sistema nella posizione a castello si compone con scaletta in alluminio anodizzato fissata ad entrambi i letti che ha anche funzione di ulteriore supporto portante. Barriere di protezione reclinabili nelle versioni metallo e imbottite. Testata imbottita reclinabile in base al tipo di barriera utilizzata, meccanismo di inclinazione integrato nel letto superiore per facilitarne il rifacimento, e sistema luce LED con paracolpi certificato e conforme alla normativa in materia. Kali Duo è disponibile nelle versioni Standard, Board (scrittoio maxi), Sofa.

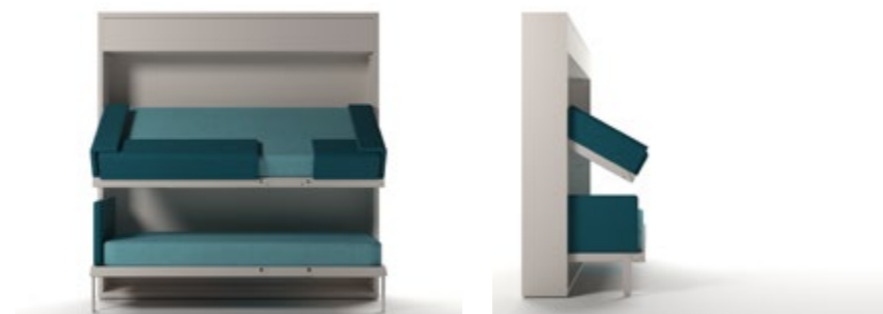

Kali Duo in the Standard version with or without a container element (H 220 cm and 194,3 cm) is a transforming system with foldaway horizontal bunk beds, with the patented CF09 slatted bed base, folding opening and a safety system to prevent accidental opening and closing. Tilting mechanism through gas springs and device that cushions movements, completely contained in the side of the structure, thanks to patented technology and special manufacturing. When the bunk beds are out, an anodised aluminium ladder is fixed to both beds and acts as an additional supporting element. Reclining safety barriers are available in metal or upholstered versions. Reclining, padded headboard depending on type of barrier used, integrated mechanism to pull upper bed down to make easier the bed, LED light system with certified anti-shock mechanism complying with relevant regulations. Kali Duo is available in the Standard, Board (large desk), Sofa versions.

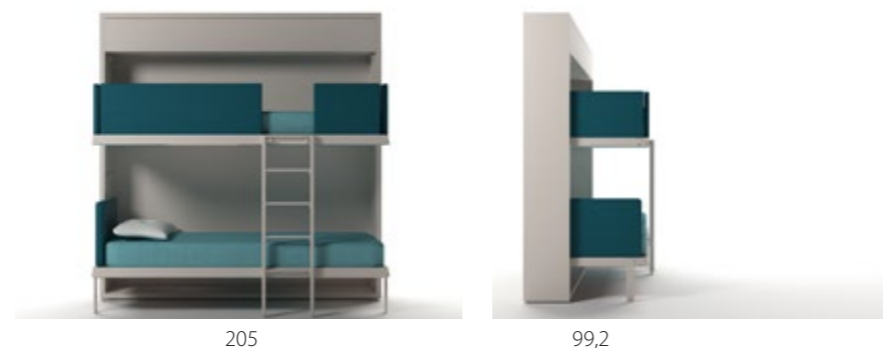

LETTO +
LETTO +
SCRITTOIO +
= **KALI DUO BOARD**

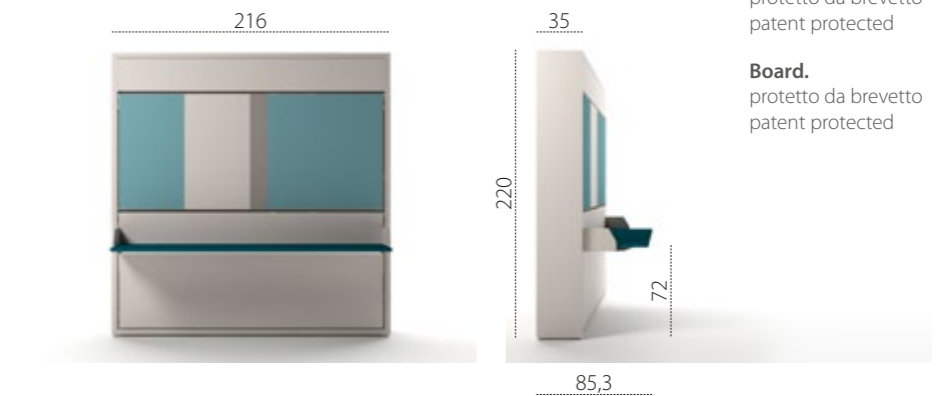

Rete CF09.
protetta da brevetto
patent protected

Kali Duo.
protetto da brevetto
patent protected

Board.
protetto da brevetto
patent protected

KALI DUO BOARD 2200

Kali Duo Board è un sistema trasformabile letti a castello a scomparsa con rete a doghe CF09 scrittoio maxi, entrambi brevettati, che con un semplice movimento si trasforma nella versione notte senza rimuovere nulla dal piano scrittoio che bascula e si posiziona orizzontalmente sotto il letto inferiore. Sistema con apertura abbattibile e dotato del dispositivo di sicurezza che impedisce aperture e chiusure accidentali. Meccanismo di articolazione con molle a gas e dispositivo di movimento ammortizzato, totalmente incassato nel fianco del mobile mediante tecnologia brevettata e speciale lavorazione. Nella posizione con letti a castello, la scaletta in alluminio anodizzato, è fissata ad entrambi i letti e funge anche da ulteriore supporto. Il letto superiore è dotato del meccanismo di inclinazione per facilitarne il rifacimento, e le barriere di protezione sono reclinabili nelle versioni metallo e imbottite. La testata tessile è reclinabile, in base al tipo di barriera utilizzata. Kali Duo ha un sistema luce LED con paracolpi, certificato e conforme alla normativa in materia. Il mobile è realizzato nelle altezze 194,3 e 220 cm; in H 220 cm è completo di elemento contenitore con anta a scomparsa. Kali Duo è disponibile nelle versioni Standard, Board (scrittoio maxi), Sofa.



Kali Duo Board is a transforming foldaway bunk bed system with the CF09 slatted bed base and large desk, both patented, which transforms into the night-time version with a simple movement without the need to remove anything from the large desk that tilts and slots in horizontally underneath the bed. The system features a fold-down opening mechanism and safety device that prevents accidental opening and closing. Tilting mechanism with gas springs and device that cushions movements, completely contained in the side of the structure, thanks to patented technology and special manufacturing. In the bunk bed position, the anodised aluminium ladder is fixed to both the beds and also acts as an additional support. The upper bed features a mechanism to pull upper bed down to make bed easier and the protection barriers are reclining in the metal and padded versions. The fabric headboard reclines, depending on the kind of barrier used. Kali Duo has a LED light system with a certified anti-shock mechanism in compliance with relevant regulations. The system is produced 194,3 or 220 cm; high H 220 cm features a storage element with a tilting door. Kali Duo is available in the Standard, Board (large desk), Sofa versions.



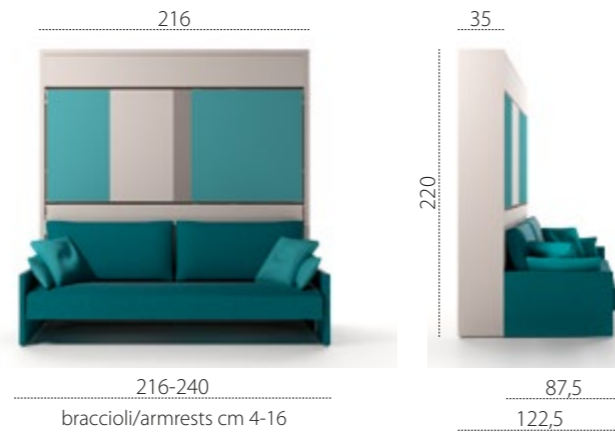

Rete CF09.
protetta da brevetto
patent protected

Kali Duo.
protetto da brevetto
patent protected

Sofa.
protetto da brevetto
patent protected

KALI DUO SOFA 2200

Kali Duo Sofa è un sistema trasformabile con letti a castello a scomparsa e con rete a doghe brevettata CF09 e con divano brevettato che con un semplice movimento si trasforma nella versione notte: rimuovendo i cuscini di schienale, con l'apertura del letto inferiore, il divano con struttura basculante arretra e con movimento traslatorio si posiziona sotto al letto.

Sistema con apertura abbattibile e dotato del dispositivo di sicurezza che impedisce aperture e chiusure accidentali. Meccanismo di articolazione con molle a gas e dispositivo di movimento ammortizzato, totalmente incassato nel fianco del mobile mediante tecnologia brevettata e speciale lavorazione.

Nella posizione con letti a castello, la scaletta in alluminio anodizzato, è fissata ad entrambi i letti e funge anche da ulteriore supporto.

Il letto superiore è dotato del meccanismo di inclinazione per facilitarne il rifacimento, le barriere di protezione sono reclinabili, nelle versioni metallo e imbottite. La testata tessile è reclinabile, in base al tipo di barriera utilizzata.

Kali Duo ha un sistema luce LED con paracolpi, certificato e conforme alla normativa in materia.

Il mobile è realizzato nelle altezze 194,3 e 220 cm; in H 220 cm è completo di elemento contenitore con anta a ribalta. Kali Duo è disponibile anche nelle versioni Standard e Board (scrittoio maxi).

Kali Duo Sofa is a transforming foldaway bunk bed system with the patented CF09 slatted bed base and patented sofa, which transforms into the night-time version with a simple movement: the backrest cushions are removed and as the lower bed is opened, the sofa tilts backwards and slots in underneath the bed.

The system features a fold-down opening mechanism and safety device that prevents accidental opening and closing.

Tilting mechanism with gas springs and device that cushions movements, completely contained in the side of the structure, thanks to patented technology and special manufacturing.

In the bunk bed position, the anodised aluminium ladder is fixed to both the beds and also acts as an additional support.

The upper bed features a mechanism to pull bed down to make the bed easier, and the protection barriers are reclining in the metal and padded versions.

The fabric headboard reclines, depending on the kind of barrier used.

Kali Duo has a LED light system with a certified anti-shock mechanism in compliance with relevant regulations.

The system is produced 194,3 or 220 cm; high H 220 cm features a storage element with a tilting door. Kali Duo is also available in the Standard and Board (large desk) versions.

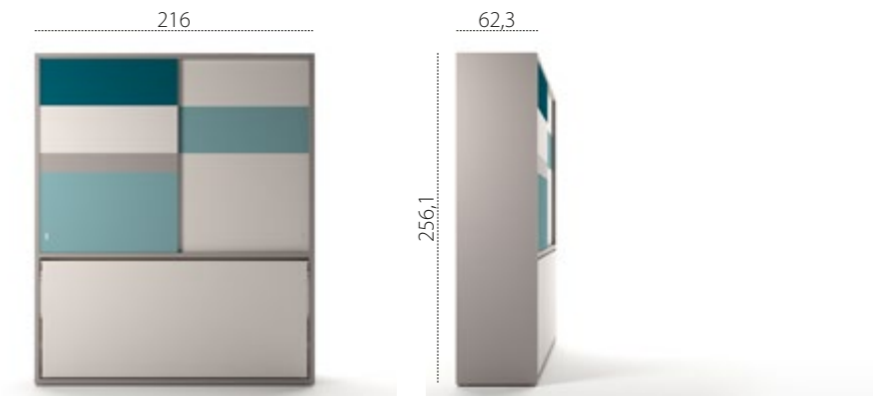
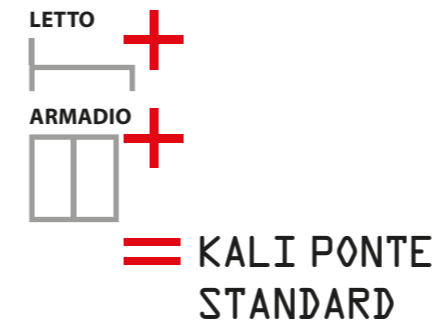

Rete CF09.
protetta da brevetto
patent protected

KALI PONTE STANDARD 2561

Kali ponte in versione Standard, con armadio a ponte con ante scorrevoli, nelle altezze cm 220 e 256,1 è un sistema componibile trasformabile con letto singolo orizzontale a scomparsa, apertura abbattibile, testata tessile reclinabile, rete a doghe brevettata CF09 e dispositivo di sicurezza che impedisce aperture e chiusure accidentali.

Meccanismo di articolazione con molle a gas e dispositivo di movimento ammortizzato, totalmente incassato nel fianco del mobile mediante tecnologia brevettata e speciale lavorazione.

Kali Ponte è disponibile anche nelle versioni Board (scrittoio maxi), Sofa.

Kali Ponte in the Standard version with a bridge wardrobe with sliding doors, 220 and 256,1 cm high. It is a transforming modular system with a foldaway horizontal single bed, fold-down opening mechanism, reclining fabric headboard, patented CF09 slatted bed base and safety device that prevents accidental opening and closing.

Tilting mechanism with gas springs and device that cushions movements, completely contained in the side of the structure, thanks to patented technology and special manufacturing.

Kali Ponte is also available in the Board (large desk), Sofa versions.



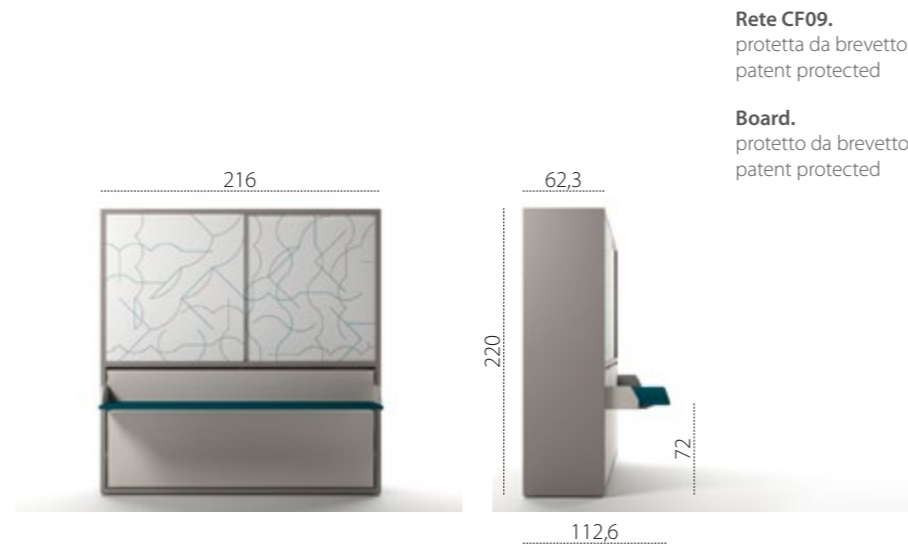
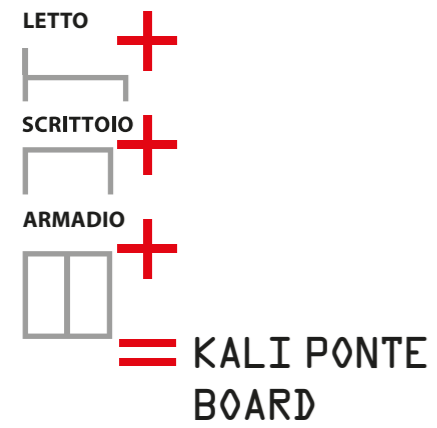

Rete CF09.
protetta da brevetto
patent protected

Board.
protetto da brevetto
patent protected

KALI PONTE BOARD 2200

Sistema componibile trasformabile con letto singolo orizzontale a scomparsa, con rete a doghe brevettata CF09, testata reclinabile e scrittoio maxi brevettato, integrato con elemento armadio ponte, ad ante scorrevoli, disponibile nelle altezze cm 220 e 256,1.

Sistema con apertura abbattibile e dotato del dispositivo di sicurezza che impedisce aperture e chiusure accidentali.

Meccanismo di articolazione con molle a gas e dispositivo di movimento ammortizzato, totalmente incassato nel fianco del mobile mediante tecnologia brevettata e speciale lavorazione.

Il sistema trasformabile con un semplice movimento si trasforma nella versione notte senza rimuovere nulla dal grande piano scrittoio che bascula e si posiziona orizzontalmente sotto al letto.

Transforming modular system with horizontal foldaway single bed with patented CF09 slatted bed base, reclining headboard and large patented desk, integrated with bridge wardrobe element with sliding doors, available 220 and 256,1 cm high.

The system features a fold-down opening mechanism and safety device that prevents accidental opening and closing.

Tilting mechanism with gas springs and device that cushions movements, completely contained in the side of the structure, thanks to patented technology and special manufacturing.

With a simple movement, the system transforms into the night-time version without the need to remove anything from the large desk that tilts and slots in horizontally underneath the bed.



Rete CF09.
protetta da brevetto
patent protected

Sofa.
protetto da brevetto
patent protected

KALI PONTE SOFA 256,1

Sistema componibile trasformabile con letto singolo orizzontale a scomparsa, con rete a doghe brevettata CF09, testata reclinabile e divano brevettato integrato con elemento armadio ponte, ad ante scorrevoli, disponibile nelle altezze cm 220 e 256,1.

Sistema con apertura abbattibile e dotato del dispositivo di sicurezza che impedisce aperture e chiusure accidentali.

Meccanismo di articolazione con molle a gas e dispositivo di movimento ammortizzato, totalmente incassato nel fianco del mobile mediante tecnologia brevettata e speciale lavorazione.

Kali Ponte Sofa si trasforma nella versione notte: rimuovendo i cuscini di schienale, con l'apertura del letto inferiore, il divano con struttura basculante arretra e con movimento traslatorio si posiziona sotto al letto.

Il divano è disponibile con due tipi di braccioli di misure diverse (L 4 cm e 16 cm).

Imbottitura seduta in espanso indeformabile a quote differenziate rivestito in falda di dacron accoppiata con tela di cotone. Schienali imbottiti in piumafill rivestiti con tela di cotone.

Rivestimento sfoderabile con cucitura pizzicata.

Transforming modular system with a foldaway horizontal single bed with the patented CF09 bed base, reclining headboard and patented sofa integrated with the bridge wardrobe element with sliding doors, available 220 and 256,1 cm high.

The system features a fold-down opening mechanism and safety device that prevents accidental opening and closing.

Tilting mechanism with gas springs and device that cushions movements, completely contained in the side of the structure, thanks to patented technology and special manufacturing.

Kali Ponte Sofa transforms into the night-time version: the backrest cushions are removed and the lower bed is opened, the sofa tilts backwards and slots in underneath the bed.

The sofa is available with two types of armrest in different sizes (W 4 cm and 16 cm).

Seat padding made of graduated non-deformable foam covered with dacron bonded with cotton cloth. The backrests are padded with piumafill and upholstered with cotton cloth.

Removable covers with French stitching.



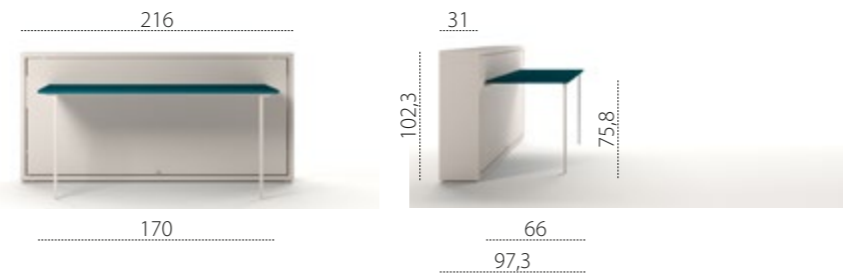
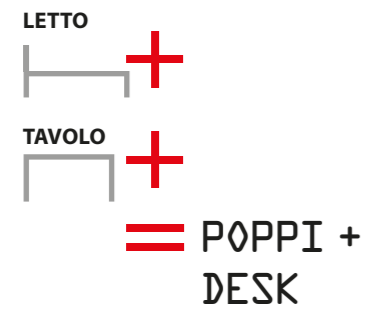

POPPI 90 + DESK

Sistema trasformabile con letto singolo o intermedio orizzontale a scomparsa, apertura abbattibile e con piano tavolo a ribalta con gambe richiudibili. Il sistema è disponibile anche nelle versioni senza tavolo (letto singolo, Poppi 90, e letto intermedio, Poppi 120) e può essere autonomo o integrato con gli elementi dei programmi Living o Young System.

Transforming system with a foldaway horizontal single or intermediate bed, fold-down opening mechanism and with a flap desk with folding legs. The system is also available in the versions without table (single bed, Poppi 90, and intermediate bed, Poppi 120) and can be free-standing or integrated with elements in the Living & Young System programs.

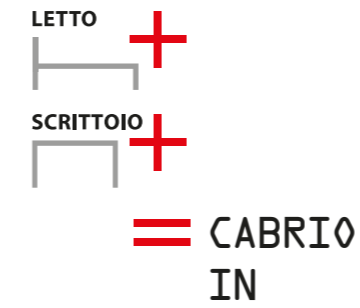

CABRIO IN.
protetto da brevetto
patent protected

CABRIO IN

Sistema trasformabile per zona studio/lavoro integrabile nei programmi Living & Young System. Il sistema coniuga uno scrittoio elevabile di grandi dimensioni con un letto singolo. Con un letto singolo che con un semplice movimento si trasforma nella versione notte senza dover rimuovere nulla dal piano scrittoio. Il mobile si completa con elementi base e pensili con ante a giorno, accostabili e disponibili in varie dimensioni.

Transforming system for studying/working purposes, it can be integrated into the Living & Young System modular programs. The system is composed of a wide lifting up writing desk and a single bed. By a simple movement it transforms into the night configuration without removing any objects from the top. The system is completed by floor cabinets wall units either with or without door, which can be combined and are available in various sizes.

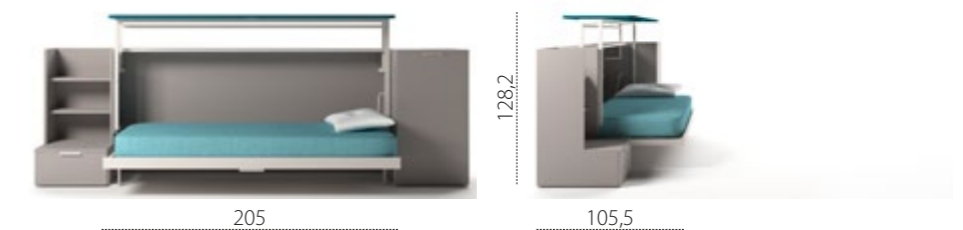

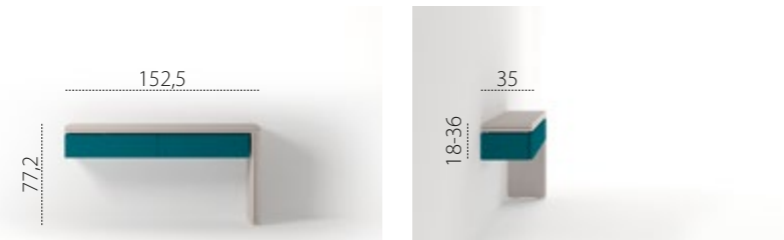
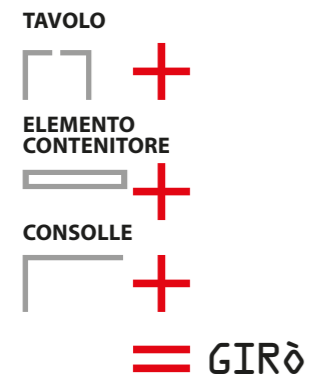

GIRÒ

Tavolo/consolle con meccanismo rotante e apertura a libro. Il sistema vincolato e sovrapposto all'elemento contenitore (L 144,5 cm x P 35 cm x H 18 cm con cassetti e H 36 cm con anta a ribalta) si trasforma in un tavolo.
 Il sistema tavolo/consolle è composto da due piani con apertura a libro, con gamba di supporto e meccanismo rotante.

Table/console table with rotating mechanism and bifold opening system.
 The system is fixed to and fits over the compartment section (W 144,5 cm x D 35 cm x H 18 cm with drawers and H 36 cm with flip-down door) and becomes a table.
 The table/console table system is composed of two bifolding tops, with supporting leg and rotating mechanism.

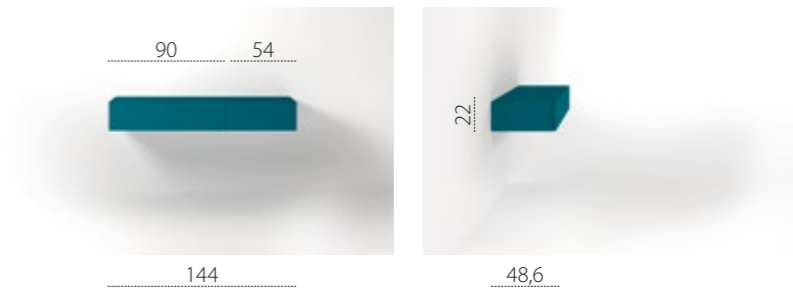
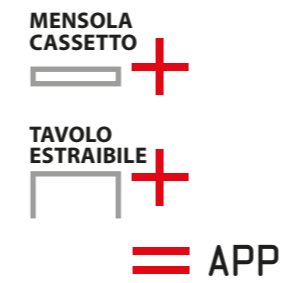
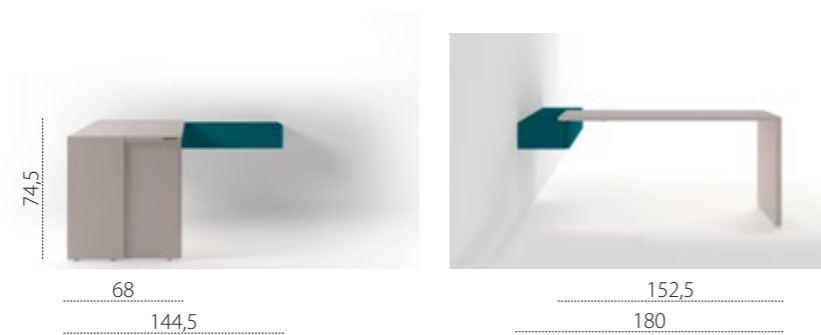
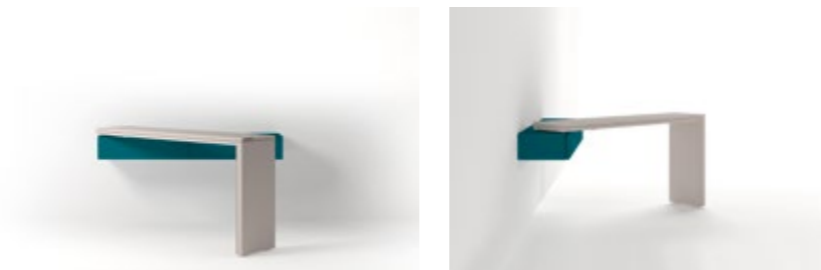

APP

App è un tavolo estraibile inserito in un elemento contenitore singolo con anta di chiusura a ribalta, con o senza cassetto laterale, da fissare a muro o su boiserie.
 Disponibile con cassetto a dx o sx.

App is a pull-out table fitted into a case element with closing flapping door, with or without lateral drawer, to be fixed on the wall or on a boiserie panel.
 Possibility to join a drawer on right or left side.

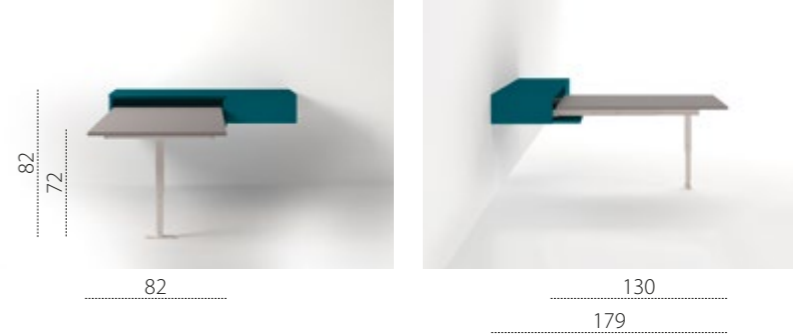

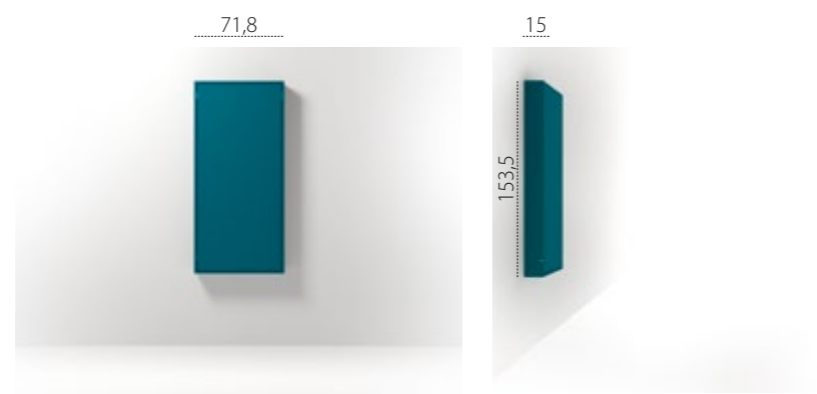

WALLY

Elemento contenitore attrezzato, con tavolo integrato con apertura a ribalta.
 Con un semplice movimento le gambe in metallo riposte lateralmente al piano si sganciano e si autobloccano nella posizione di servizio.
 Realizzato in melaminico bianco e laccato, nelle versioni con schienale attrezzato con 2 mensole o con schienale magnetico con 4 mensole organizzabili.
 In una situazione spazio giovani funge anche da scrittoio.

Case element equipped with integrated table with tilting opening.
 Through a simple movement, the metal legs placed on the side of the top are released, and they self-lock in the operating position.
 Available in melamine white and lacquered finish in the configuration with back panel equipped with 2 shelves or with magnetic back panel with 4 movable shelves.
 In a children's room, it is a writing desk as well.

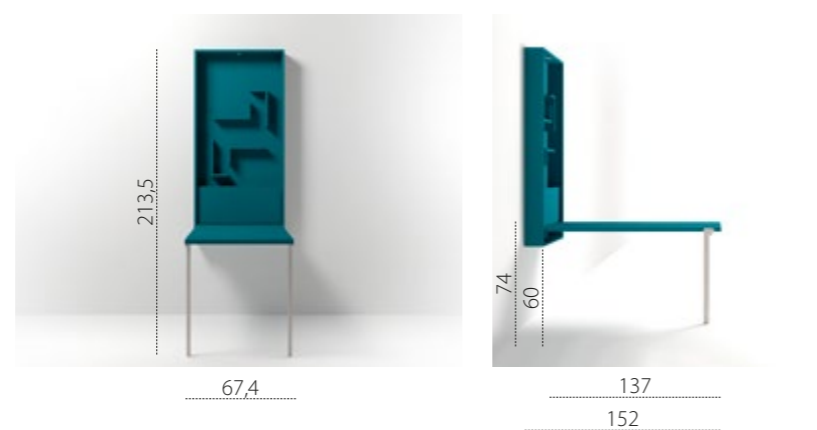

AVAILABLE SYSTEMS

TIPOLOGIA MODELLI

AVAILABLE SYSTEMS

In queste pagine una panoramica sintetica dei diversi modelli che compongono le varie famiglie dei prodotti. La gamma completa dei programmi Living & Young System con le caratteristiche tecniche dettagliate dei prodotti e delle loro possibilità di combinazione sono rappresentate sul listino di vendita.

These pages provide a brief overview of the different models that make up the various product families. The complete Living & Young System range with detailed technical characteristics of the products and their possible combinations is outlined in the sales list.

Tango

Tango Componibile 198

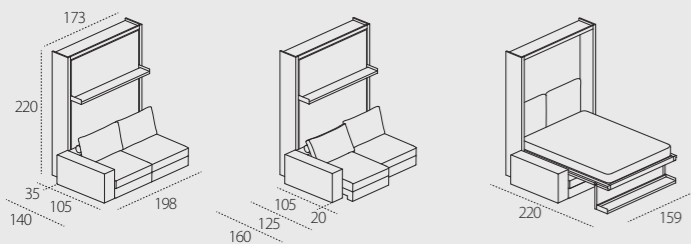

Tango Componibile 241

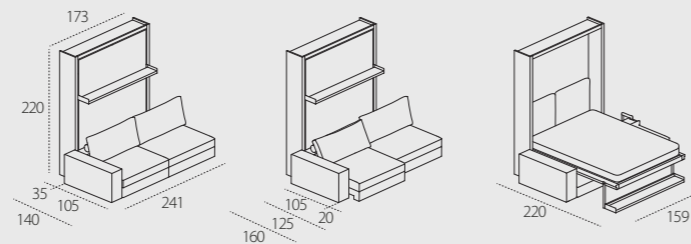

Tango Divano 223

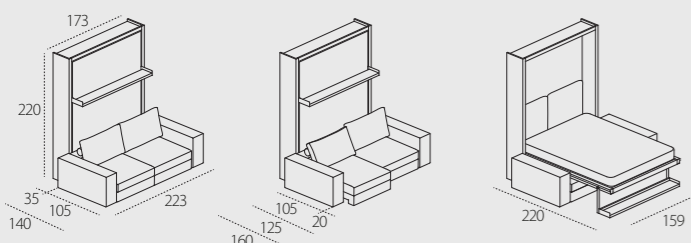

Tango Divano 270

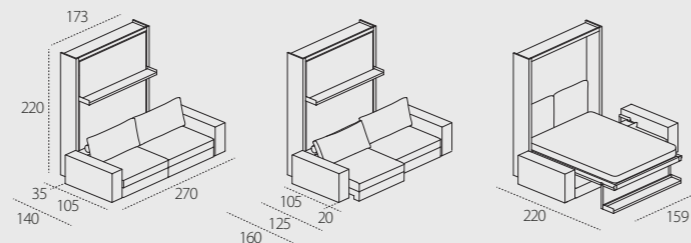

Tango autonomo 190 Tango autonomo 223 Tango autonomo 270

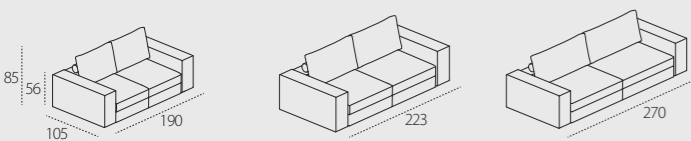

Oslo Divano 173

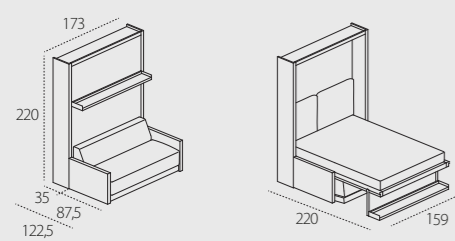

Oslo Divano 301

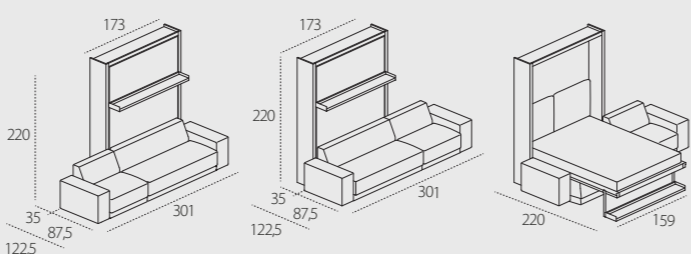

Oslo

Swing

Swing

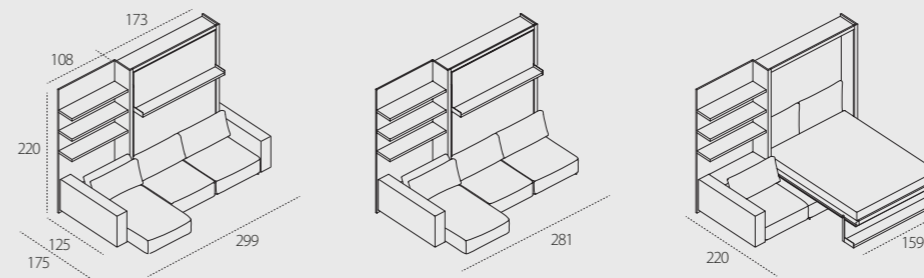

Ito 016

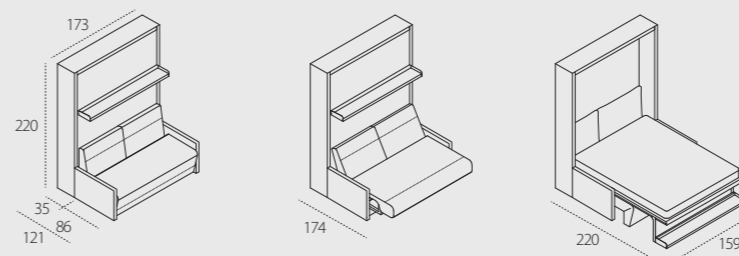

Ito

Atoll

Atoll

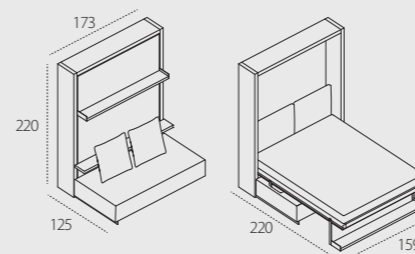

Atoll 000

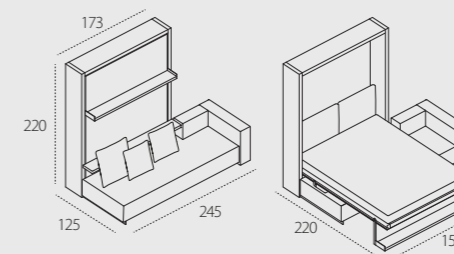

Atoll 202

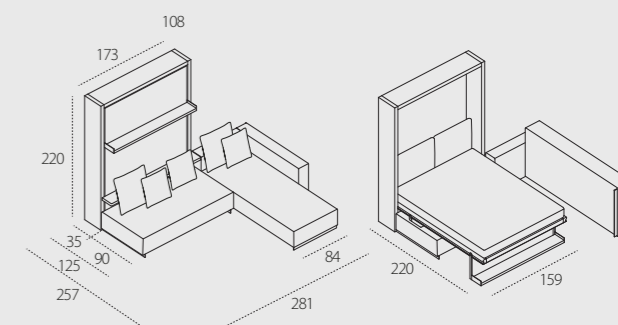

Nuovoliola

Nuovoliola 10

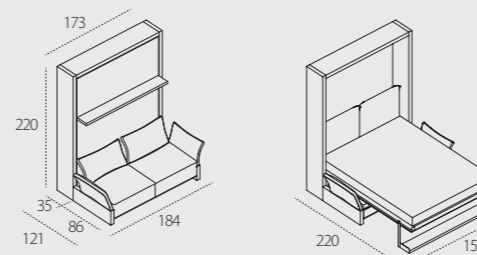

Penelope

Penelope 2 Standard - P.35

Penelope 2 Sofa - P.35
braccioli/armrests cm 4-16

Penelope 2 Dining - P.35

Penelope 2 Board - P.35

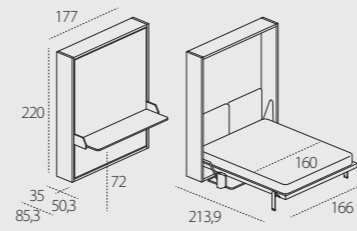
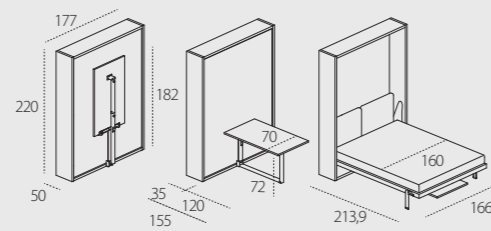
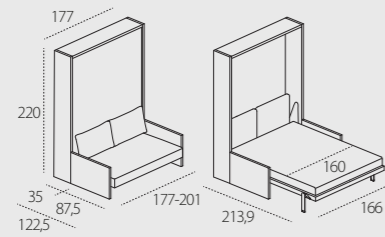
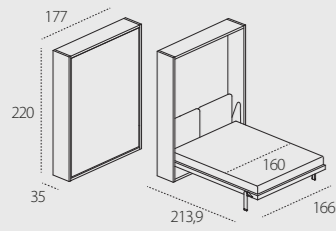

Penelope 2 Standard - P.62,3

Penelope 2 Sofa - P.62,3
braccioli/armrests cm 4-16

Penelope 2 Dining - P.62,3

Penelope 2 Board - P.62,3

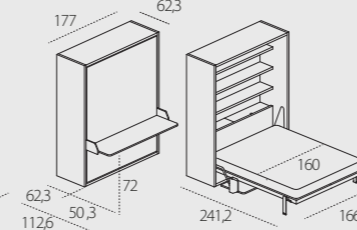
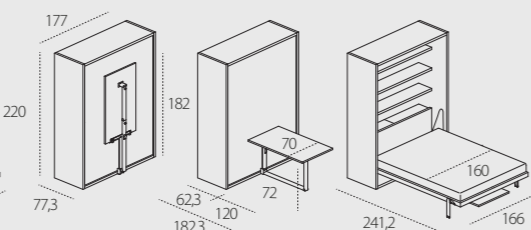
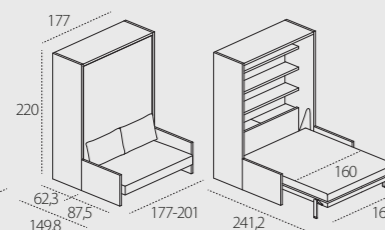
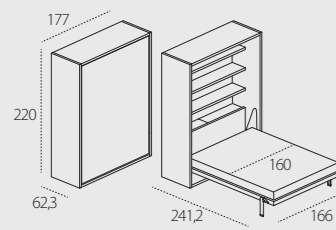

Ulisse Standard 156/167

Ulisse Sofa 156/167

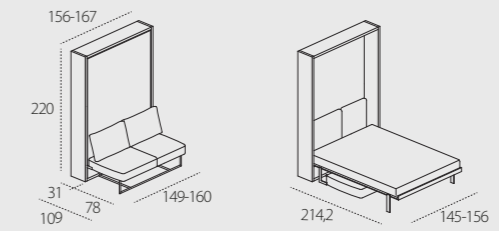
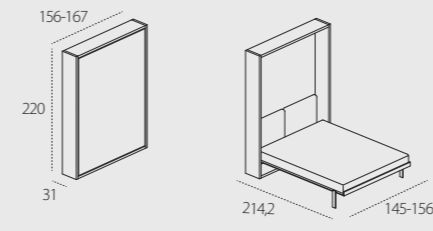

Ulisse Desk 167

Ulisse Dining 167

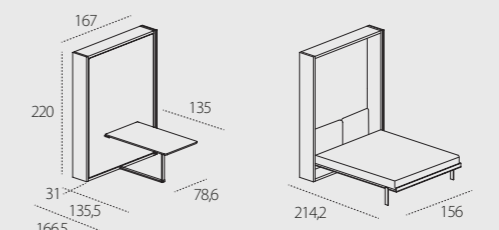
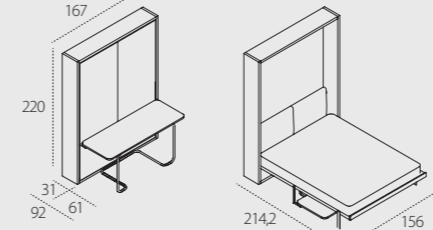

Circe

Circe Standard

Circe Sofa
braccioli/armrests cm 4-16

Circe Board

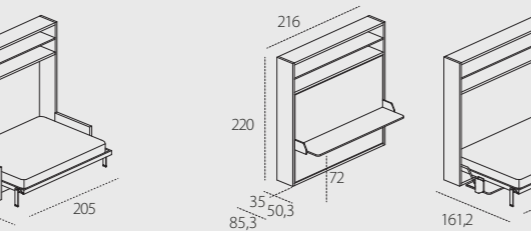
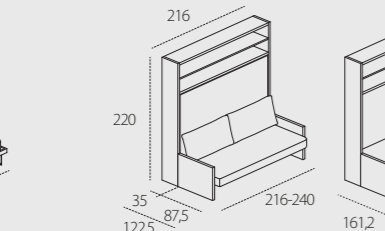
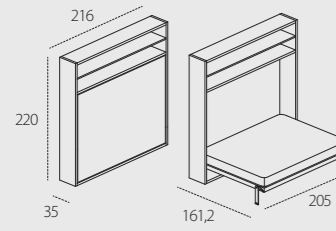

Big Standard

Big Sofa

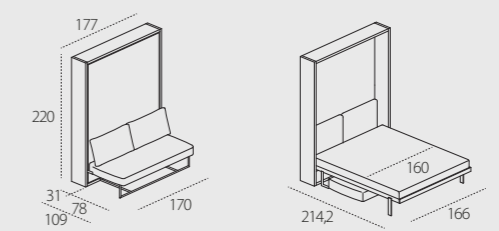
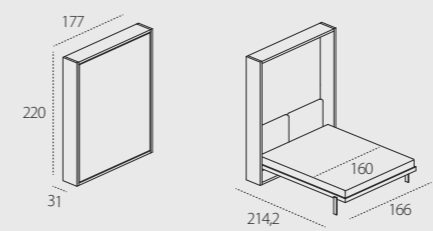

Big

Adam Standard

Adam Sofa

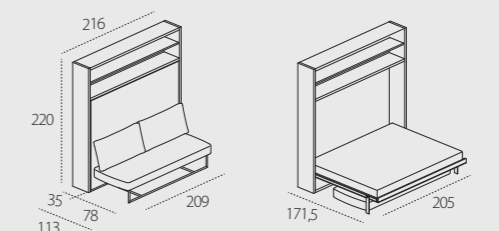
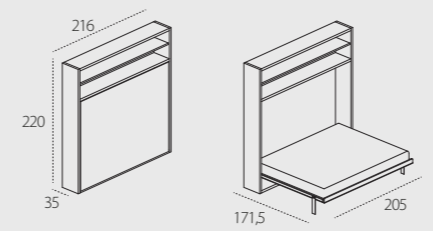

Adam

LGM

LGM

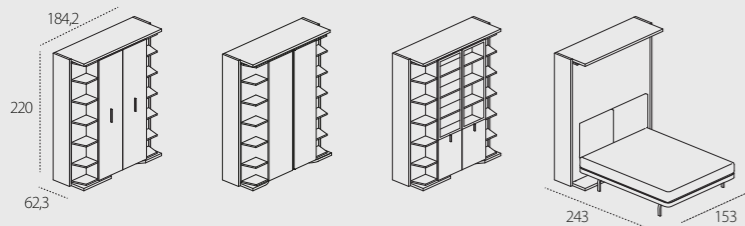

LGM01

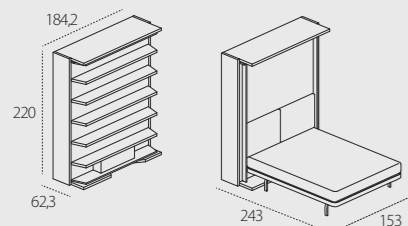

LGM01/TAV

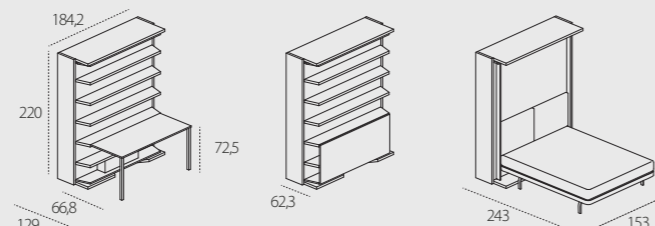

Kitchen Box

Kitchen Box - versione Plus

anta attrezzata dx o sx/equipped door right or left

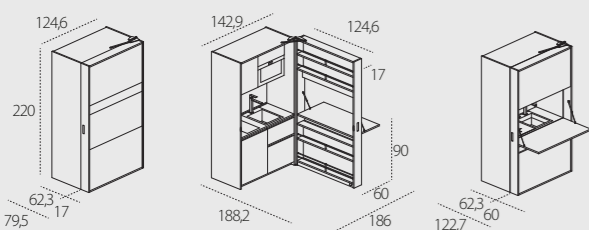

Kitchen Box - versione Basic

anta attrezzata dx o sx/equipped door right or left

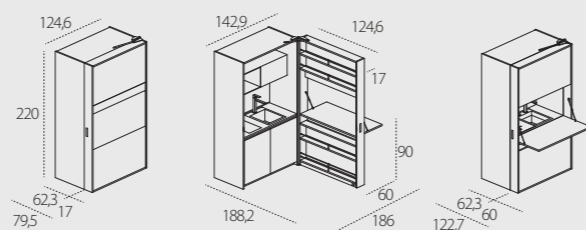

Altea

Altea 90 Standard - P.35

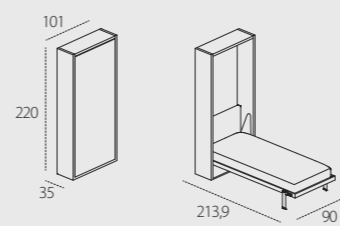

Altea 90 Sofa - P.35

braccioli/armrests cm 4-16

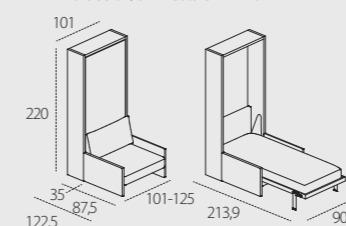

Altea 90 Work - P.35

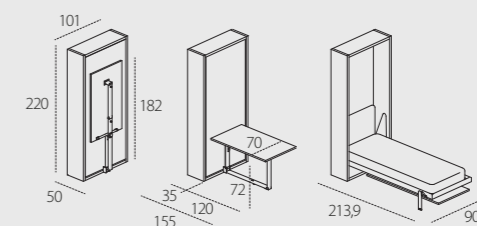

Altea 90 Board - P.35

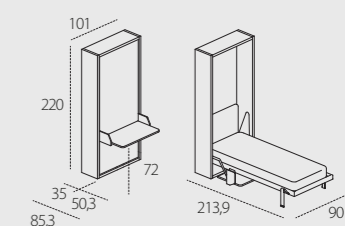

Altea 120 Standard - P.35

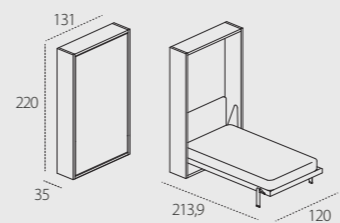

Altea 120 Sofa - P.35

braccioli/armrests cm 4-16

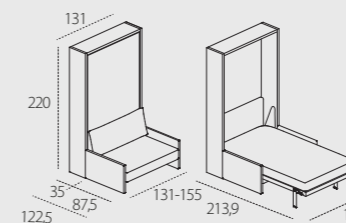

Altea 120 Work - P.35

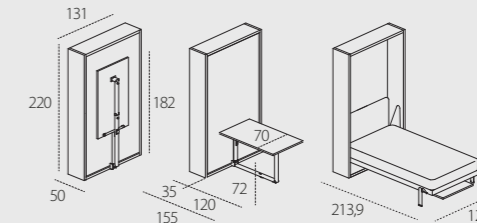

Altea 120 Board - P.35

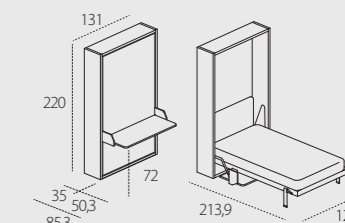

Altea Book 90 Standard - P.62,3

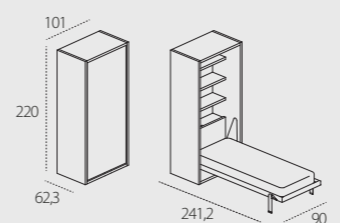

Altea Book 90 Sofa - P.62,3

braccioli/armrests cm 4-16

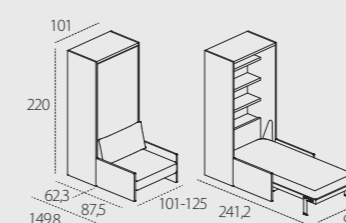

Altea Book 90 Work - P.62,3

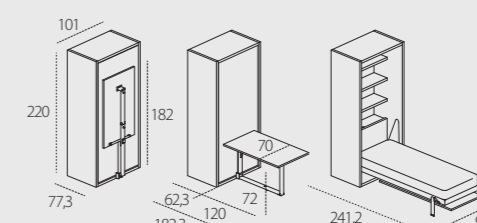

Altea Book 90 Board - P.62,3

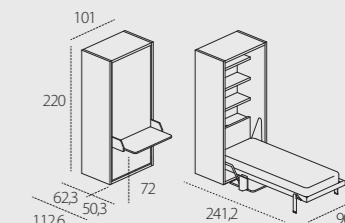

Altea Book 120 Standard - P.62,3

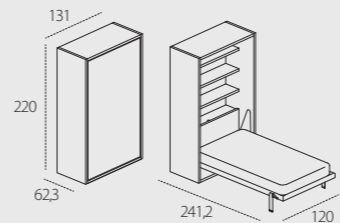

Altea Book 120 Sofa - P.62,3

braccioli/armrests cm 4-16

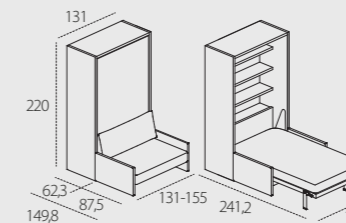

Altea Book 120 Work - P.62,3

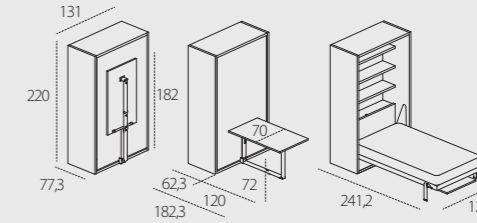

Altea Book 120 Board - P.62,3

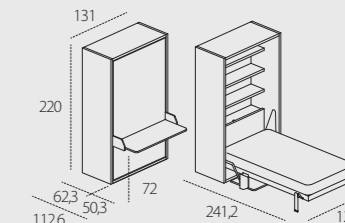

Telemaco

Telemaco 90 Standard

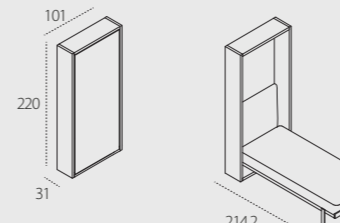

Telemaco 90 Desk

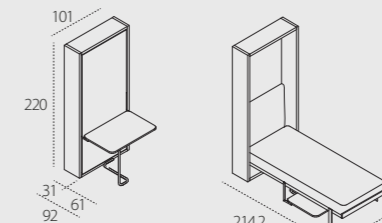

Telemaco 90 Work

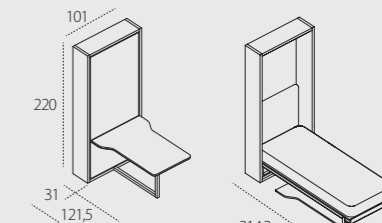

Telemaco 120 Standard

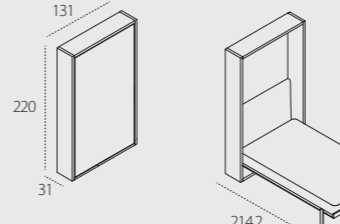

Telemaco 120 Desk

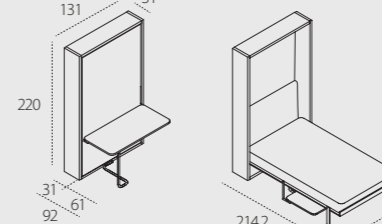

Kali

Kali Standard 90

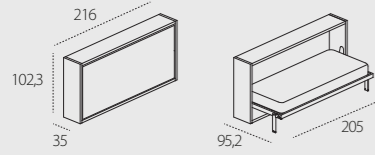

Kali Board 90

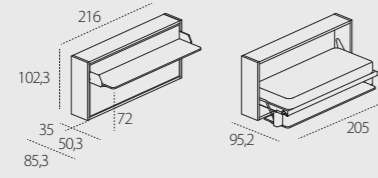

Kali Sofa 90
braccioli/armrests cm 4-16

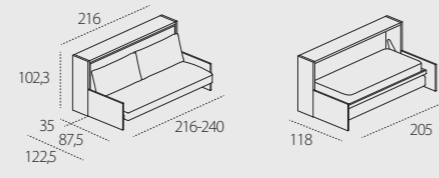

Kali Standard 120

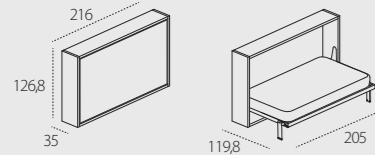

Kali Board 120

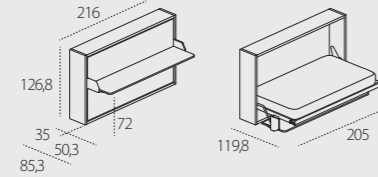

Kali Sofa 120
braccioli/armrests cm 4-16

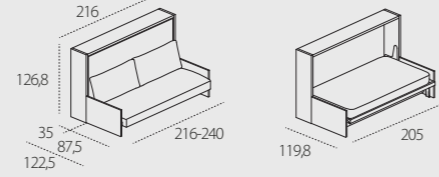

Kali Duo Standard 1943

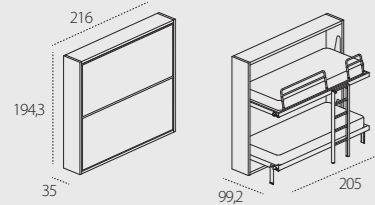

Kali Duo Board 1943

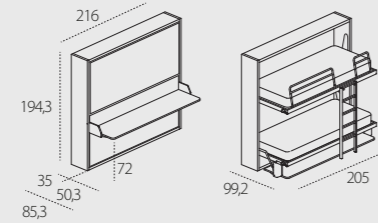

Kali Duo Sofa 1943
braccioli/armrests cm 4-16

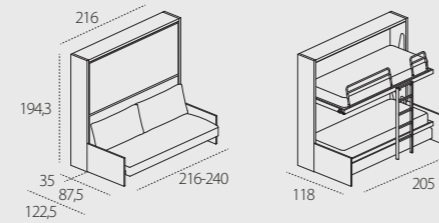

Kali Duo Standard 2200

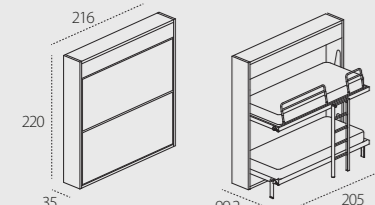

Kali Duo Board 2200

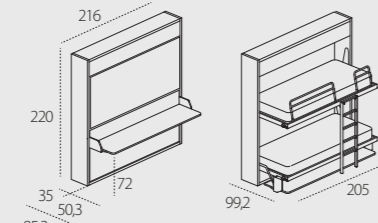

Kali Duo Sofa 2200
braccioli/armrests cm 4-16

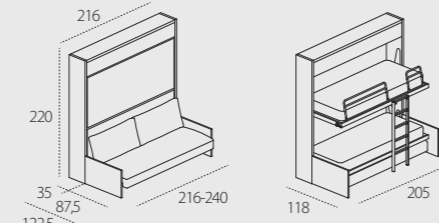

Kali Ponte Standard 2200

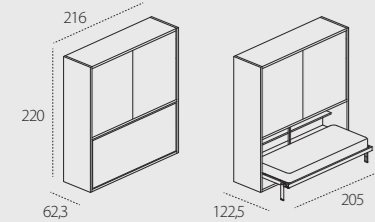

Kali Ponte Board 2200

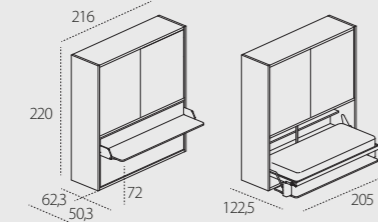

Kali Ponte Sofa 2200
braccioli/armrests cm 4-16

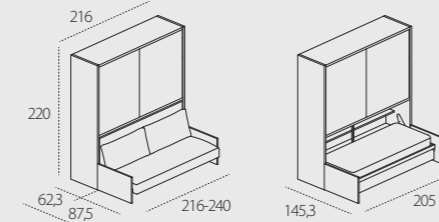

Kali Ponte Standard 2561

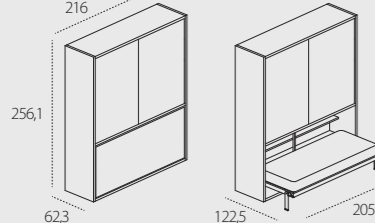

Kali Ponte Board 2561

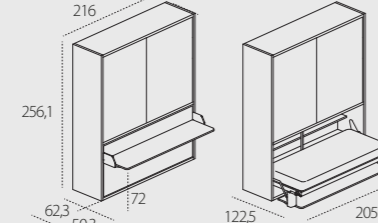

Kali Ponte Sofa 2561
braccioli/armrests cm 4-16

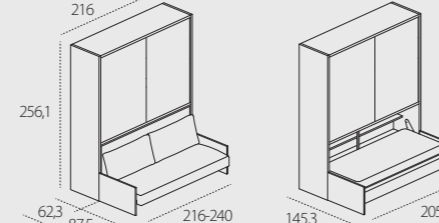

Poppi

Poppi 90 Standard

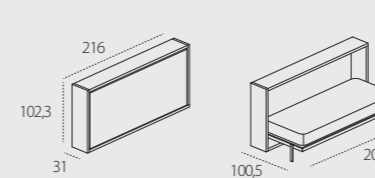

Poppi 90 + Desk

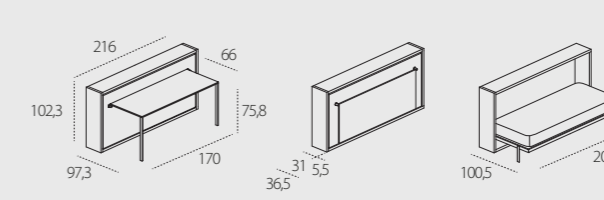

Poppi 90 + Book

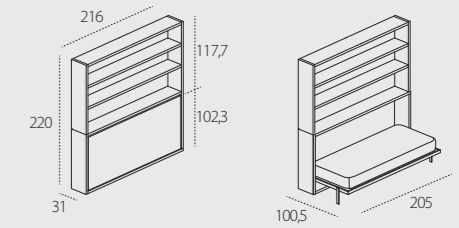

Poppi 120 Standard

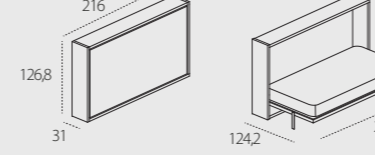

Poppi 120 + Desk

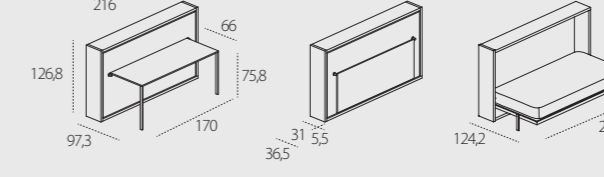

Poppi Theatre

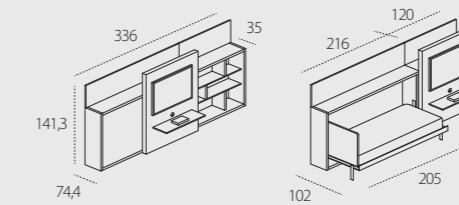

Lollipop Lollisoft

Lollipop 90 I Standard

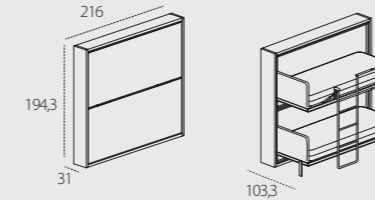

Lollipop 90 R Standard

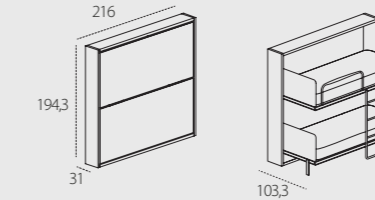

Lollipop 90 I + Desk

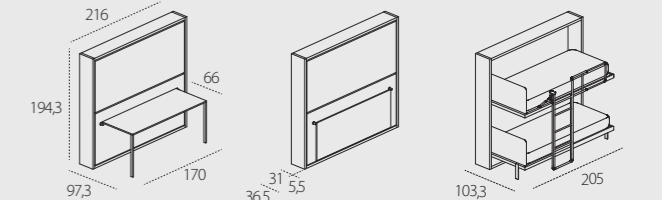

Lollipop 220 I Standard

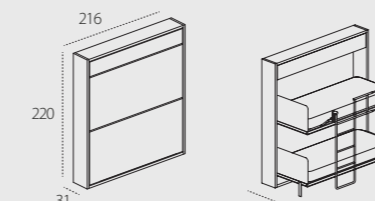

Lollipop 220 R Standard

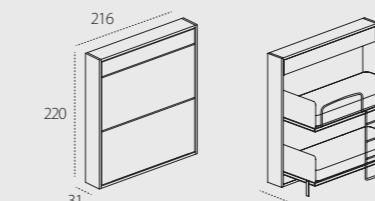

Lollipop 220 I + Desk

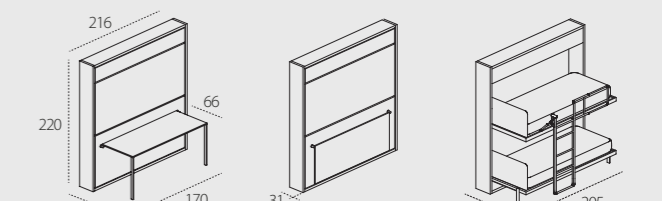

Lollisoft 90 Standard

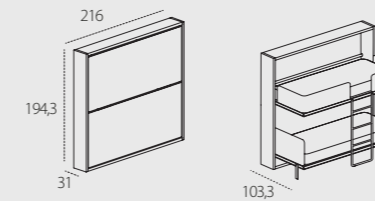

Lollisoft 90 Standard CEE

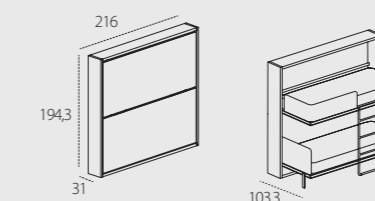

Lollisoft 220 Standard

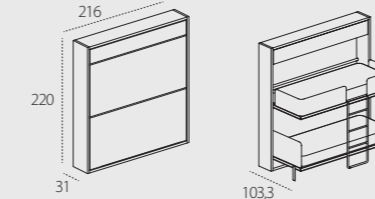

Lollisoft 220 Standard CEE

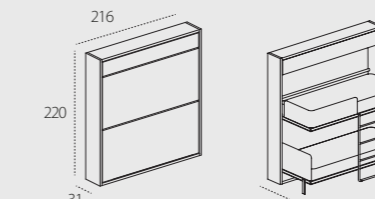

Doc.

Doc.
divano letto/sofa bunk bed

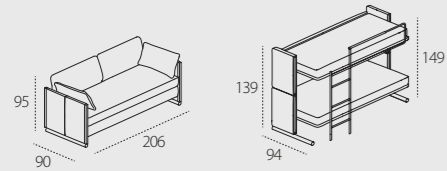

Cabrio In
letto con scrittoio elevabile/bed with lifting up desk

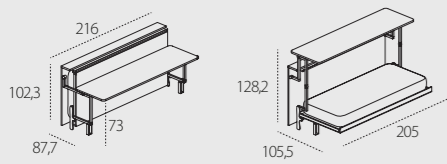

Home Office 1478
contenitore libreria con piano scrittoio a ribalta/
storing bookcase with tilting desk top

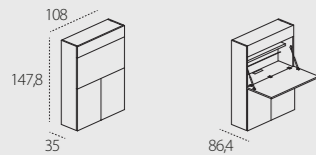

Home Office 2200
contenitore libreria con piano scrittoio a ribalta/
storing bookcase with tilting desk top

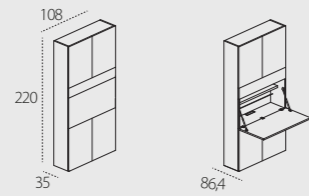

Cabrio In

Home Office

Girò

Girò
tavolo/console a libro con meccanismo rotante/
table/bi-folding console with rotation mechanism

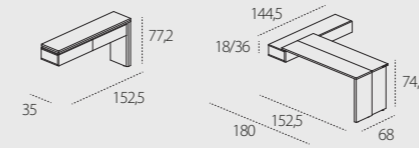

App
mensola cassetto per tavolo estraibile - 90/
shelf with drawer for pullout table - 90

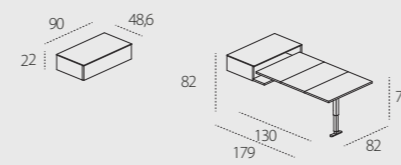

App
mensola cassetto per tavolo estraibile - 144/
shelf with drawer for pullout table - 144

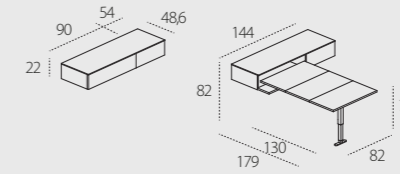

App

Wally
tavolo a ribalta integrato, schienale legno/
integrated tilting table, wooden back panel

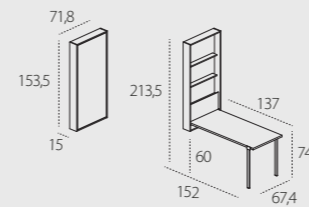

Wally
tavolo a ribalta integrato, schienale magnetico/
integrated tilting table, magnetic back panel

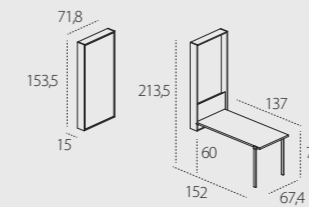

Wally
tavolo a ribalta integrato, schienale magnetico con mensole/
integrated tilting table, magnetic back panel with shelves

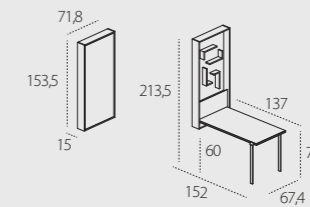

Wally

Miguel 60
chaise longue relax - 60

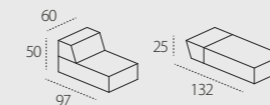

Miguel 84
chaise longue relax - 84

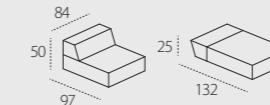

Miguel

Pouf
quadrato fisso e su ruote/
square fixed or on wheels



quadrato fisso/
square fixed



rotondo fisso/
square fixed



rotondo fisso/
square fixed



pouf Tango 1050x800



pouf Tango 1050x1050

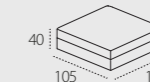

pouf Oslo



Pouf

ANA - LYTI - CAL INDEX

INDICE ANALITICO

ANALYTICAL INDEX

Altea 120 Sofa - P35	62 • 70 • 108 • 123
Altea Book 90 Standard - P62,3	36 • 124
Altea Book 120 Board - P62,3	90 • 126
Altea Book 120 Sofa - P62,3	44 • 90 • 127
Altea Book 120 Work - P62,3	80 • 125
—	—
App	32 • 141
—	—
Cabrio In	100 • 108 • 139
—	—
Girò	70 • 90 • 140
—	—
Kali Board 90	129
Kali Board 120	14 • 24 • 130
Kali Duo Board 2200	44 • 133
Kali Duo Sofa 2200	54 • 134
Kali Duo Standard 2200	58 • 132
Kali Ponte Board 2200	62 • 136
Kali Ponte Sofa 2561	100 • 137
Kali Ponte Standard 2561	70 • 135
Kali Sofa 120	24 • 36 • 80 • 131
Kali Standard 90	14 • 32 • 128
—	—
Miguel 60	14
—	—
Poppi 90 + Desk	138
—	—
Wally	36 • 118 • 142
—	—
Living & Young System	14 • 24 • 32 • 36 • 44 • 62 • 70 • 80 • 90 • 100 • 108
Tetris	14 • 24 • 32 • 36 • 44 • 54 • 62 • 70 • 90

Clei si riserva il diritto di apportare, senza preavviso, ogni modifica mirata al miglioramento funzionale e qualitativo dei propri prodotti.

Immagini, testi e disegni di questo catalogo hanno scopo divulgativo.

La descrizione e le immagini dei prodotti non possono essere considerate vincolanti ai fini del loro utilizzo.

Per ogni aspetto tecnico e dimensionale, fare riferimento al listino aziendale e relativi aggiornamenti.

Clei reserves the right to make, without prior notice, any changes designed to improve the functionality and quality of its products.

The images, texts and drawings in this catalogue are for information purposes only.

Descriptions and images of products cannot be considered binding with regard to their use.

For technical and measurement details, please refer to the company catalog and its updates.

—
© 2017 - Clei s.r.l.

Printed in Italy - 01.2017

—
a.d.
pierluigi colombo

mktg & comunicazione
e.a. foresti - studio assioma

images
modofotografia, enrico colzani

graphic
romanoassociati.com

copy
giuseppe ravera

styling
moi et toi

print
grafiche boffi

coordinamento
cinzia porro - u.t. clei

—
SEDE OPERATIVA

22060 Carugo (CO) Italy
via G. Marconi
tel. +39.031.761666 fax +39.031.762346
info@clei.it export@clei.it www.clei.it

DIVISIONE CONTRACT

20833 Giussano (MB) Italy
via G. Garibaldi 139
tel. +39.031.763228 fax +39.031.762346
info.contract@clei.it www.clei.it



SEDE OPERATIVA: 22060 Carugo (CO) Italy via G. Marconi tel. +39.031.761666 fax +39.031.762346 info@clei.it export@clei.it www.clei.it

DIVISIONE CONTRACT: 20833 Giussano (MB) Italy via G. Garibaldi 139 tel. +39.031.763228 fax +39.031.762346 info.contract@clei.it www.clei.it