



TOTAL HYDRAULIC &
INDUSTRIAL SOLUTIONS

HYDRAULIC HOSE AND COUPLINGS



2026 EDITION



SERVICES OVERVIEW

TOTAL HYDRAULIC & INDUSTRIAL SOLUTIONS



HOSE & TUBE ASSEMBLY



- WHILE YOU WAIT HOSES
- 2" HYDRAULIC CRIMPING
- 3" INDUSTRIAL CRIMPING
- 1-1/2" HYDRAULIC TUBING
- CUSTOM FITTINGS
- SPECIAL ORDER UP TO 12" CRIMPED



CYLINDER REPAIR



- WE REPAIR ALL STYLES OF HYDRAULIC AND PNEUMATIC CYLINDERS
- SMALL TO LARGE WE HANDLE IT ALL
- IN HOUSE MACHINING
- QUICK TURN AROUND
- LARGE TEAR DOWN BENCH



LARGE INVENTORY



- COMMON PARTS TO DIAMOND RARE... WE STOCK A WIDE SELECTION OF SOLUTIONS TO TACKLE YOUR PROBLEMS RIGHT NOW
- MULTIPLE SOURCES FOR EVERYDAY COMPONENTS TO ENSURE YOUR PRODUCT GETS DELIVERED ON TIME



ONLINE STORE



- OVER 8000 ITEMS
- OUR HIGHEST MOVING ITEMS
- INVENTORY STOCK LEVELS
- KITS AND PACKAGES
- SAVE TIME AND MONEY
- ADDING NEW ITEMS CONSTANTLY



DELIVERY & VMI



- OUTSIDE SALES SUPPORT
- PRODUCT DELIVERY / PICKUP
- CONSULTATION SERVICES
- VENDOR MANAGED INVENTORY OPTIONS



WHOLESALE



- MULTIPLE BRANDS OF PRODUCT
- DROP SHIP / DELIVERY / PICKUP
- CRIMPERS / SAWS / EQUIPMENT
- STORAGE SOLUTIONS
- BIN LABELS WITH BAR CODE



2460 COMMERCIAL BLVD
STATE COLLEGE, PA 16801



(814) 954-5752



SALES@OHHOSESHOP.COM



WWW.OHHOSESHOP.COM

PRODUCT CATEGORIES

FIND WHAT YOU NEED. FAST & EASY.



HYDRAULIC HOSE

PG
1-14



BRAIDED HOSE FITTINGS

PG
15-32



SPIRAL HOSE FITTINGS

PG
33-46



2 PIECE HOSE FITTINGS

PG
47-54



DOT 100R5 FITTINGS

PG
55-60



HOSE PROTECTION

PG
61-68



THREAD ID

PG
69-75



2460 COMMERCIAL BLVD
STATE COLLEGE, PA 16801



(814) 954-5752



SALES@QHHOSESHOP.COM



WWW.QHHOSESHOP.COM

HOSE FITTING GUIDE

COMMON CRIMP & FIELD ATTACHABLE FITTINGS



RELIABLE
High quality materials for long lasting performance



LEAK FREE
Engineered for a secure, dependable connection



WIDE COMPATIBILITY
Designed to work with leading hose types and equipment



FAST & EASY
Built for quick installation and reduced downtime

QUICK REFERENCE GUIDE



BF21 SERIES – PARKER 43 SERIES INTERCHANGE

- **Suitable to be used on:** Forza Uno, Forza Duo, Balpac 3000, Balpac Premium, 2-Jack
- **Type:** Crimp (Non-Reusable)
- **Applications:** General medium to high pressure hydraulic lines
- **Interchange:** Parker 43 Series



CS SERIES – WEATHERHEAD U SERIES INTERCHANGE & DAYCO HY SERIES INTERCHANGE

- **Suitable to be used on:** Forza Uno, Forza Duo, Balpac 3000, Balpac Premium, 2-Jack
- **Type:** Crimp (Non-Reusable)
- **Applications:** General medium to high pressure hydraulic lines
- **Interchange:** Weatherhead U Series, Dayco HY Series



MA SERIES – GATES GLOBAL CRIMP SERIES INTERCHANGE

- **Suitable to be used on:** Forza Uno, Forza Duo, Balpac 3000, Balpac Premium, 2-Jack
- **Type:** Crimp (Non-Reusable)
- **Applications:** General medium to high pressure hydraulic lines
- **Interchange:** Gates Global Crimp Series



A SERIES – EATON TTC/Z SERIES INTERCHANGE

- **Suitable to be used on:** Forza Uno, Forza Duo, Balpac 3000, Balpac Premium, 2-Jack
- **Type:** Crimp (Non-Reusable)
- **Applications:** General medium to high pressure hydraulic lines
- **Interchange:** Eaton TTC / Z Series



2 PC SERIES

- **Suitable to be used on:** Forza Uno, Forza Duo, Balpac 3000, Balpac Premium, 2-Jack
- **Type:** Crimp (Non-Reusable)
- **Applications:** General medium to high pressure hydraulic lines
- **Interchange:** 100R7/R8 Thermoplastic, 100R14 PTFE, 100R6 1TE, 100R4 Suction



BW23 SERIES

- **Suitable to be used on:** Forza Uno, Forza Duo, Balpac 3000, Balpac Premium, 2-Jack, BestFlex 4SH, 100R4 Suction
- **Type:** Crimp (Non-Reusable)
- **Applications:** High pressure & 4-spiral hose



R5 SERIES

- **Suitable to be used on:** 100R5 DOT Cloth Covered Hose
- **Type:** Crimp (Non-Reusable)
- **Applications:** Fuel, brake, and oil lines
- **Standards:** DOT FMVSS 106 Compliant



R5-RU SERIES – REUSABLE / FIELD SERVICEABLE

- **Suitable to be used on:** 100R5 DOT Cloth Covered Hose
- **Type:** Reusable (Field Serviceable)
- **Applications:** Fuel, brake, and oil lines
- **Standards:** DOT FMVSS 106 Compliant



FITTING TIPS

- Always match the fitting series to the correct hose and application.
- Use the proper crimp equipment for secure, leak-free assemblies.
- Reusable fittings must be assembled per manufacturer instructions.

NEED HELP?

Our team is here to help you choose the right fitting for your application. Contact us for custom solutions!



















HYDRAULIC HOSE

QUICK REFERENCE GUIDE





















<p>Texmaster 100R6 Low Pressure</p>  <p>Page 1</p>	<p>Tornare 100R4 Suction/Return</p>  <p>Page 2</p>	<p>Forza Uno 100R1AT 1 Wire Braided</p>  <p>Page 3</p>	<p>Forza Duo Tropic 100R2AT - Hi-Temp 2 Wire Braided</p>  <p>Page 4</p>
<p>Balpac 3000 100R17 3000 PSI Braided</p>  <p>Page 5</p>	<p>Balpac Premium 100R16 2 Wire Braided</p>  <p>Page 6</p>	<p>2-Max Jack Specialty 10K Jack Hose</p>  <p>Page 7</p>	<p>BestFlex 100R13/15 4 Wire Sprial</p>  <p>Page 8</p>
<p>ZetaFlex 100R7NC Thermoplastic Non-Conductive</p>  <p>Page 9</p>	<p>ZetaFlex-Twin 100R7NC-TL Thermoplastic Non-Conductive Twinline</p>  <p>Page 9</p>	<p>OmegaFlex 100R8 Thermoplastic</p>  <p>Page 10</p>	<p>OmegaFlex 100R8-TL Thermoplastic</p>  <p>Page 10</p>
<p>Balflon 100R14 Braided Stainless PTFE</p>  <p>Page 11</p>	<p>Balflon Convoluted 100R14C Braided Stainless PTFE</p>  <p>Page 12</p>	<p>DOT Fuel/Air/Oil 100R5 Standard Temp Black</p>  <p>Page 13</p>	<p>DOT Fuel/Air/Oil 100R5 Hi-Temp Blue</p>  <p>Page 14</p>

BRAIDED HOSE FITTINGS

















<p>Male Pipe MP / 01</p>  <p>Page 15</p>	<p>Male Pipe Swivel MPX / 04</p>  <p>Page 15</p>	<p>Male Pipe Swivel 90° MPX90 / 14</p>  <p>Page 16</p>	<p>Female Pipe Swivel FPX / 05</p>  <p>Page 16</p>
<p>Male ORB RA / 11</p>  <p>Page 17</p>	<p>Male ORB Swivel RAX / 12</p>  <p>Page 17</p>	<p>Male ORB Swivel 90° RAX90 / 15</p>  <p>Page 18</p>	<p>Male JIC MJ / 08</p>  <p>Page 18</p>
<p>Female JIC FJ / 09</p>  <p>Page 19</p>	<p>Female JIC 45° FJ45 / 25</p>  <p>Page 20</p>	<p>Female JIC 90° Short FJ90S / 17</p>  <p>Page 20</p>	<p>Female JIC 90° FJ90 / 26</p>  <p>Page 21</p>
<p>Female JIC 90° Long FJ90L / 27</p>  <p>Page 21</p>	<p>Male ORFS OFTM / 29</p>  <p>Page 22</p>	<p>Female ORFS OFT / 30</p>  <p>Page 22</p>	<p>Female ORFS 45° OF45 / 31</p>  <p>Page 23</p>

BRAIDED HOSE FITTINGS

QUICK REFERENCE GUIDE











<p>Female ORFS 90° OF90 / 32</p>  <p>Page 23</p>	<p>Female ORFS 90° Long OF90L / 33</p>  <p>Page 24</p>	<p>SAE Code 61 PA / 47</p>  <p>Page 24</p>	<p>SAE Code 61 45° PA45 / 50</p>  <p>Page 25</p>
<p>SAE Code 61 90° PA90 / 53</p>  <p>Page 25</p>	<p>BSPP Male BSPM / 36</p>  <p>Page 26</p>	<p>BSPP Female BSPXF / 10</p>  <p>Page 26</p>	<p>BSPP Female 45° BSPXF45 / 43</p>  <p>Page 27</p>
<p>BSPP Female 90° BSPXF90 / 46</p>  <p>Page 27</p>	<p>DIN L Male DLM / 66</p>  <p>Page 28</p>	<p>DIN L Female DLF / 37</p>  <p>Page 28</p>	<p>DIN L Female 45° DLF45 / 41</p>  <p>Page 29</p>
<p>DIN L Female 90° DLF90 / 44</p>  <p>Page 29</p>	<p>DIN H Male DHM / 67</p>  <p>Page 30</p>	<p>DIN H Female DHF / 38</p>  <p>Page 30</p>	<p>DIN H Female 45° DHF45 / 42</p>  <p>Page 31</p>
<p>DIN H Female 90° DHF90 / 45</p>  <p>Page 31</p>	<p>JIS Metric Female FX-KOMA / 39</p>  <p>Page 32</p>	<p>JIS Metric Female 90° FX-KOMA90</p>  <p>Page 32</p>	<p>JIS BSPP Female JIS / 40</p>  <p>Page 32</p>

SPIRAL HOSE FITTINGS











<p>Male Pipe MP</p>  <p>Page 33</p>	<p>Male Pipe Swivel MPX</p>  <p>Page 33</p>	<p>Female Pipe Swivel FPX</p>  <p>Page 33</p>	<p>Male ORB RA</p>  <p>Page 34</p>
<p>Male JIC MJ</p>  <p>Page 34</p>	<p>Female JIC FJ</p>  <p>Page 34</p>	<p>Female JIC 45° FJ45</p>  <p>Page 35</p>	<p>Female JIC 90° FJ90</p>  <p>Page 35</p>
<p>Female JIC 90° Long FJ90L</p>  <p>Page 35</p>	<p>ORFS Male OFTM</p>  <p>Page 36</p>	<p>ORFS Female OFT</p>  <p>Page 36</p>	<p>ORFS Female 45° OF45</p>  <p>Page 36</p>
<p>ORFS Female 90° OF90</p>  <p>Page 37</p>	<p>ORFS Female 90° Long OF90L</p>  <p>Page 37</p>	<p>SAE Code 61 PA</p>  <p>Page 38</p>	<p>SAE Code 61 45° PA45</p>  <p>Page 38</p>
<p>SAE Code 61 90° PA90</p>  <p>Page 38</p>	<p>SAE Code 62 PH</p>  <p>Page 39</p>	<p>SAE Code 62 45° PH45</p>  <p>Page 39</p>	<p>SAE Code 62 90° PH90</p>  <p>Page 39</p>

SPIRAL HOSE FITTINGS

QUICK REFERENCE GUIDE









<p>CAT Flange SC</p>  <p>Page 40</p>	<p>CAT Flange 45° SC45</p>  <p>Page 40</p>	<p>CAT Flange 90° SC90</p>  <p>Page 40</p>	<p>BSP Male BSPM</p>  <p>Page 41</p>
<p>BSP Female BSPXF</p>  <p>Page 41</p>	<p>BSP Female 45° BSPXF45</p>  <p>Page 42</p>	<p>BSP Female 90° BSPXF90</p>  <p>Page 42</p>	<p>DIN L Male DLM</p>  <p>Page 43</p>
<p>DIN L Female DLF</p>  <p>Page 43</p>	<p>DIN L Female 45° DLF45</p>  <p>Page 43</p>	<p>DIN L Female 90° DLF90</p>  <p>Page 43</p>	<p>DIN H Male DHM</p>  <p>Page 44</p>
<p>DIN H Female DHF</p>  <p>Page 44</p>	<p>DIN H Female 45° DHF45</p>  <p>Page 44</p>	<p>DIN H Female 90° DHF90</p>  <p>Page 44</p>	<p>JIS Metric FX-KOMA</p>  <p>Page 45</p>
<p>JIS BSP JIS</p>  <p>Page 45</p>			

2 PIECE HOSE FITTINGS

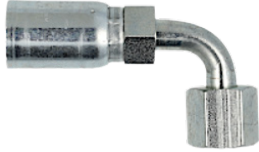



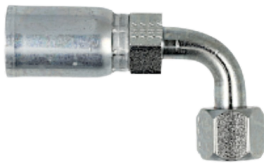

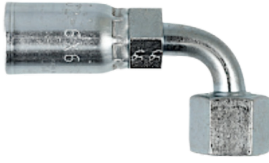
<p>Crimp Ferrules</p>  <p>Page 47</p>	<p>Male Pipe MP</p>  <p>Page 48</p>	<p>Male Pipe Swivel MPX</p>  <p>Page 48</p>	<p>Male JIC MJ</p>  <p>Page 49</p>
<p>Female JIC FJ</p>  <p>Page 49</p>	<p>Female JIC 45° FJ45</p>  <p>Page 50</p>	<p>Female JIC 90° FJ90</p>  <p>Page 50</p>	<p>Male ORFS OFTM</p>  <p>Page 51</p>
<p>Female ORFS OFT</p>  <p>Page 51</p>	<p>Female ORFS 45° OF45</p>  <p>Page 52</p>	<p>Female ORFS 90° OF90</p>  <p>Page 52</p>	<p>Male BSPP BSPM</p>  <p>Page 53</p>
<p>Female BSPP BSPXF</p>  <p>Page 53</p>	<p>Female BSPP 45° BSPXF45</p>  <p>Page 54</p>	<p>Female BSPP 90° BSPXF90</p>  <p>Page 54</p>	

RS CRIMP FITTINGS

QUICK REFERENCE GUIDE

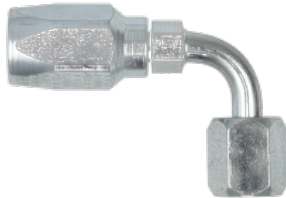
<p>Male Pipe PM</p>  <p>Page 55</p>	<p>Female SAE Flare SFS</p>  <p>Page 55</p>	<p>Female SAE Flare 90° SFS90</p>  <p>Page 55</p>
<p>Male JIC JM</p>  <p>Page 56</p>	<p>Female JIC JFS</p>  <p>Page 56</p>	<p>Female JIC 45° JFS45</p>  <p>Page 57</p>
<p>Female JIC 90° JFS90</p>  <p>Page 57</p>	<p>Female ORFS OFS</p>  <p>Page 58</p>	<p>Female ORFS 45° OFS45</p>  <p>Page 58</p>
	<p>Female ORFS 90° OFS90</p>  <p>Page 58</p>	

RS REUSEABLE FITTINGS

<p>Male Pipe PM</p>  <p>Page 59</p>	<p>Female SAE Flare SFS</p>  <p>Page 59</p>	<p>Female SAE Flare 90° SFS90</p>  <p>Page 59</p>
<p>Female JIC JFS</p>  <p>Page 60</p>	<p>Female JIC 45° JFS45</p>  <p>Page 60</p>	<p>Female JIC 90° JFS90</p>  <p>Page 60</p>

HOSE PROTECTION

QUICK REFERENCE GUIDE

ProTec Nylon Hose Sleeve



Page 61

ProWrap HDPE Hose Coil



Page 62

Steel Spring Hose Guard



Page 63

Fiberglass Silicone Hose Sleeve



Page 64

Aluminum Fiberglass Heat Sleeve



Page 65

Hose Protector



Page 66

Color Coding Shrink Tubing

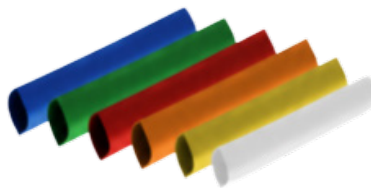

Page 67

LOW PRESSURE HOSE

TEXMASTER 1



DIN EN 854 1TE / SAE 100R6

Medium pressure, single textile braid reinforced hydraulic hose

RETURN LINE ONLY



LOW PRESSURE



SINGLE TEXTILE BRAID REINFORCEMENT



COMPRESSED AIR, WATER



RETURN LINE APPLICATIONS

Dash Size	Inside Diameter 	Outside Diameter 	Working Pressure PSI 	Burst Pressure PSI 	Minimum Bend Radius 	Available Packaging	Part Number
-03	3/16"	0.43"	500	2000	2.01"	25', 50' Coils, 164' Reel	1TE-R6-03
-04	1/4"	0.49"	410	1640	2.52"	25', 50' Coils, 164' Reel	1TE-R6-04
-05	5/16"	0.55"	410	1640	2.99"	25', 50' Coils, 164' Reel	1TE-R6-05
-06	3/8"	0.61"	410	1640	2.99"	25', 50' Coils, 164' Reel	1TE-R6-06
-08	1/2"	0.73"	410	1640	4.02"	25', 50' Coils, 164' Reel	1TE-R6-08
-10	5/8"	0.90"	350	1400	5.00"	25', 50' Coils, 164' Reel	1TE-R6-10
-12	3/4"	1.05"	310	1240	6.00"	25', 50' Coils, 164' Reel	1TE-R6-12
-14	7/8"	1.23"	320	1280	7.87"	25', 50' Coils, 164' Reel	1TE-R6-14
-16	1"	1.30"	250	1000	7.99"	25', 50' Coils, 164' Reel	1TE-R6-16



INNER TUBE:
Seamless oil resistant synthetic rubber



REINFORCEMENT:
1 high resistance textile braid



OUTER TUBE:
Black wrapped, oil, weather and abrasion resistant synthetic rubber



APPLICATION:
Petroleum base hydraulic fluids, Compressed Air, Water



TEMPERATURE RANGE:
-40°C (-40°F) to +100°C (+212°F);
Intermittent service: +120°C (+248°F);
Max. temperature recommended for water base hydraulic fluids: +70°C (+158°F);
Max. temperature recommended for air: +50°C (+122°F)



AVAILABLE PACKAGING:
25', 50' Coils, 164' Reel



COUPLINGS:
Hose barb with Clamps, or 2 piece Stem/Ferrule



COVER:
U.S. MSHA APPROVED

SAFETY FACTOR: 4:1

SUCTION HOSE

SAE 100R4



SUCTION & RETURN HYDRAULIC HOSE

According to SAE J517 type SAE 100R4, suction & delivery hydraulic hose.



OIL RESISTANT TUBE









STEEL WIRE HELIX REINFORCEMENT



VACUUM SERVICE RATED



SUCTION & RETURN APPLICATIONS

Dash Size	Inside Diameter 	Outside Diameter 	Working Pressure PSI 	Burst Pressure PSI 	Weight (Lbs/Ft) 	Bend Radius 	Available Packaging 	Part Number
-12	3/4"	1.37"	310	1,240	0.50	5"	25', 50', 100' Coils, 131' Spool	R4-12
-16	1"	1.65"	250	1,000	0.63	6"	25', 50', 100' Coils, 131' Spool	R4-16
-20	1-1/4"	2.00"	210	840	0.84	8"	25', 50', 100' Coils, 131' Spool	R4-20
-24	1-1/2"	2.25"	160	640	1.04	10"	25', 50', 100' Coils, 131' Spool	R4-24
-32	2"	2.75"	110	440	1.34	12"	25', 50', 100' Coils, 131' Spool	R4-32
-40	2-1/2"	3.25"	60	240	1.68	14"	25', 50', 100' Coils, 131' Spool	R4-40
-48	3"	3.75"	60	240	2.15	18"	25', 50', 100' Coils, 131' Spool	R4-48
-64	4"	4.76"	40	160	3.39	24"	10, 25' Coils, 65.5' Spool	R4-64



INNER TUBE:
Seamless oil resistant synthetic rubber



OUTER TUBE:
Black wrapped, oil, weather and abrasion resistant synthetic rubber



TEMPERATURE RANGE:
-40°C (-40°F) to +100°C (+212°F);
Intermittent service: +120°C (+248°F);
Max. temperature recommended for hydraulic fluids: +70°C (+158°F);
Max. temperature recommended for air: +60°C (+140°F)



COUPLINGS:
Hose barb with T-Bolt Clamp, Crimped Balflex BW23 Series, or Crimped 2 pc stem/ferrule Combination



REINFORCEMENT:
Textile braids and 1 high strength steel wire helix



APPLICATION:
Suction, delivery, return & discharge of petroleum base hydraulic fluids



SAFETY FACTOR: 4:1



COVER:
U.S. MSHA approved

FORZA UNO - SHARK SKIN HIGH PRESSURE HYDRAULIC HOSE



DIN EN 853 1SN / SAE 100R1AT\

High pressure, single steel braid reinforced hydraulic hose



HIGH TEMPERATURE RATING



HIGH PRESSURE



SINGLE STEEL BRAID REINFORCEMENT



PETROLEUM BASE HYDRAULIC FLUIDS



EXCELLENT ABRASION RESISTANCE

Part Number	Hose I.D.	Hose O.D.	Working Pressure PSI	Min. Burst Pressure PSI	Min. Bend Radius (In.)	Weight lbs/ft	Packaging
R1AT-03-SC	3/16" (-4)	0.520	3,000	12,000	3	0.10	25', 50', 100' Coils or 250' Reels
R1AT-04-SC	1/4" (-4)	0.580	3,000	12,000	3.4	0.11	25', 50', 100' Coils or 250' Reels
R1AT-05-SC	5/16" (-5)	0.680	2,250	9,000	4	0.15	25', 50', 100' Coils or 250' Reels
R1AT-06-SC	3/8" (-6)	0.770	2,000	8,000	4.6	0.20	25', 50', 100' Coils or 250' Reels
R1AT-08-SC	1/2" (-8)	0.921	1,750	7,000	5.5	0.25	25', 50', 100' Coils or 250' Reels
R1AT-10-SC	5/8" (-10)	1.080	1,500	6,000	6.5	0.31	25', 50', 100' Coils or 250' Reels
R1AT-12-SC	3/4" (-12)	1.240	1,500	6,000	7.4	0.44	25', 50', 100' Coils or 250' Reels
R1AT-16-SC	1" (-16)	1.500	1,250	5,000	9	0.53	25', 50', 100' Coils or 250' Reels
R1AT-20-SC	1-1/4" (-20)	1.750	1,000	4,000	10.5	0.61	25', 50', 100' Coils or 250' Reels
R1AT-24-SC	1-1/2" (-24)	1.900	900	3,600	13.2	0.85	25', 50', 100' Coils or 250' Reels
R1AT-32-SC	2" (-32)	2.190	725	2,900	16	1.10	25', 50', 100' Coils or 250' Reels



INNER TUBE:
Seamless oil resistant synthetic rubber



REINFORCEMENT:
1 high tensile steel wire braid



OUTER TUBE:
Black wrapped, oil, weather and abrasion resistant synthetic rubber

SAFETY FACTOR: 4:1



APPLICATION:
Petroleum base hydraulic fluids



TEMPERATURE RANGE:
-40°C (-40°F) to +100°C (+212°F)
Intermittent: +120°C (+248°F)



COUPLINGS:
BF21 Series
BW23 Series
CS "Weatherhead U" Series (interchange)
MA "Gates Global Crimp" Series (interchange)
A "Aeroquip 1A / Eaton Z" Series (interchange)



COVER:
U.S. MSHA APPROVED



AVAILABLE PACKAGING:
25', 50', 100' Coils
328' Reel (for -03 thru -08)
164' Reel (for -10 thru -16)
131' Coils (for -20 thru -32)

NOTES:

Sizes -40 (2.1/2") and -48 (3") not included in the standards.
Bafflex® hydraulic hose DIN EN 853 1SN / SAE 100R1AT has a very superior working and burst pressure compared with only SAE 100R1AT.

HIGH TEMPERATURE HOSE

FORZA DUE TROPIC



DIN EN 853 2SN / SAE 100R2AT / ISO 1436 - 10.1004.-HT

High pressure, high temperature, double steel braid reinforced hydraulic hose



HIGH TEMPERATURE RATING



HIGH PRESSURE







DOUBLE STEEL BRAID REINFORCEMENT



PETROLEUM BASE HYDRAULIC FLUIDS



EXCELLENT ABRASION RESISTANCE

Dash Size	Inside Diameter 	Outside Diameter 	Working Pressure PSI 	Burst Pressure PSI 	Minimum Bend Radius 	Available Packaging	Part Number
-03	3/16"	0.53"	6100	24400	3.50"	25', 50', 100' Coils, 328' Reel	R2AT-03-HT
-04	1/4"	0.60"	5800	23200	3.94"	25', 50', 100' Coils, 328' Reel	R2AT-04-HT
-05	5/16"	0.71"	5100	20400	4.49"	25', 50', 100' Coils, 328' Reel	R2AT-05-HT
-06	3/8"	0.84"	4800	19200	5.00"	25', 50', 100' Coils, 328' Reel	R2AT-06-HT
-08	1/2"	1.03"	4000	16000	7.00"	25', 50', 100' Coils, 328' Reel	R2AT-08-HT
-10	5/8"	1.18"	3700	14800	7.87"	25', 50', 100' Coils, 164' Reel	R2AT-10-HT
-12	3/4"	1.41"	3200	12800	9.45"	25', 50', 100' Coils, 164' Reel	R2AT-12-HT
-16	1"	1.71"	2400	9600	11.81"	25', 50', 100' Coils, 164' Reel	R2AT-16-HT
-20	1-1/4"	2.08"	1900	7600	16.50"	25', 50', 100' Coils, 131' Coils	R2AT-20-HT
-24	1-1/2"	2.29"	1400	5600	19.69"	25', 50', 100' Coils, 131' Coils	R2AT-24-HT
-32	2"	2.66"	1200	4800	24.80"	25', 50', 100' Coils, 131' Coils	R2AT-32-HT



INNER TUBE:

Seamless oil resistant synthetic rubber



REINFORCEMENT:

2 high tensile steel wire braid



OUTER TUBE:

Blue wrapped, oil, weather and abrasion resistant synthetic rubber

SAFETY FACTOR: 4:1



APPLICATION:

Petroleum base hydraulic fluids



TEMPERATURE RANGE:

Intermittent:
-40°C (-40°F) to +150°C (+302°F);
Continuous service:
+125°C (+257°F)
Max. temperature recommended for water base hydraulic fluids: +120°C (+248°F)
Max. temperature recommended for air: +60°C (+140°F)



COVER:

0.5. MSHA APPROVED



COUPLINGS:

BF21 Series
BW23 Series
CS "Weatherhead U" Series (interchange)
MA "Gates Global Crimp" Series (interchange)
A "Aeroquip 1A/ Eaton Z" Series (interchange)



AVAILABLE PACKAGING:

25', 50', 100' Coils,
328' Reel (for -03 thru -08)
164' Reel (for -10 thru -16)
131' Coils (for -20 thru -32)

Hydraulics Hose

MEDIUM PRESSURE HOSE

SAE 100R17

SHARK SKIN



SINGLE WIRE REINFORCEMENT
1/4" - 1/2"



DOUBLE WIRE REINFORCEMENT
5/8" - 1"



MEDIUM PRESSURE



STEEL WIRE BRAID REINFORCEMENT



PETROLEUM BASE HYDRAULIC FLUIDS



CONSTANT PERFORMANCE

Dash Size	Inside Diameter	Outside Diameter	Working Pressure PSI	Burst Pressure PSI	Weight (Lbs/Ft)	Bend Radius	Available Packaging	Part Number
-04	1/4"	0.492"	3,200	13,200	0.15	2"	25', 50', 100' Coils, 656' 2 PC Reel	R17-04-SC
-06	3/8"	0.637"	3,000	12,000	0.23	2.5"	25', 50', 100' Coils, 328' 1 PC Reel	R17-06-SC
-08	1/2"	0.763"	3,000	12,000	0.28	3.5"	25', 50', 100' Coils, 328' 1 PC Reel	R17-08-SC
-10	5/8"	0.952"	3,000	12,000	0.35	4"	25', 50', 100' Coils, 164' 1 PC Reel	R17-10-SC
-12	3/4"	1.11"	3,000	12,000	0.43	4.75"	25', 50', 100' Coils, 164' 1 PC Reel	R17-12-SC
-16	1"	1.40"	3,000	12,000	0.67	6"	25', 50', 100' Coils, 164' 1 PC Reel	R17-16-SC



INNER TUBE:
Seamless oil resistant synthetic rubber



REINFORCEMENT:
1 high tensile steel wire braid on sizes 1/4", 5/16", 3/8" and 1/2" and 2 braids on sizes 5/8", 3/4" and 1"



OUTER TUBE:
Black wrapped, oil, weather and abrasion resistant synthetic rubber



SAFETY FACTOR: 4:1



TEMPERATURE RANGE:
-40°C (-40°F) to +100°C (+212°F); Intermittent service: +120°C (+248°F); Max. temperature recommended for hydraulic fluids: +70°C (+158°F); Max. temperature recommended for air: +60°C (+140°F)



APPLICATION:
Petroleum base hydraulic fluids



COUPLINGS:

- BF21 Series
- BW23 Series
- CS "Weatherhead U" Series Interchange
- MA "Gates Global Crimp" Series Interchange
- A "Aeroquip 1A/ Eaton Z" Series Interchange



COVER:
U.S. MSHA APPROVED

SAE 100R17,
smooth cover.

Also available in "wrapped" cover.

Interchanges with Aeroquip FC639-16, Gates 16M3K, Parker 451-16, and Weatherhead H14516.

HIGH PRESSURE HOSE

SAE 100R16

SHARK SKIN



DOUBLE WIRE
REINFORCEMENT
1/4" - 1"

DIN EN 857 2SC / SAE 100R16 / ISO 11237 - 10.1S19.
High pressure, double steel braid reinforced hydraulic hose



HIGH
PRESSURE





STEEL WIRE BRAID
REINFORCEMENT



PETROLEUM BASE
HYDRAULIC FLUIDS



CONSTANT
PERFORMANCE

Dash Size	Inside Diameter 	Outside Diameter 	Working Pressure PSI 	Burst Pressure PSI 	Weight (Lbs/Ft) 	Bend Radius 	Available Packaging	Part Number
-04	1/4"	0.520"	6,200	24,800	0.18	2"	25', 50', 100' Coils, 656' 2 PC Reel	R16-04-SC
-06	3/8"	0.670"	5,100	20,400	0.28	2.5"	25', 50', 100' Coils, 328' 1 PC Reel	R16-06-SC
-08	1/2"	0.810"	5,000	20,000	0.35	3.5"	25', 50', 100' Coils, 328' 1 PC Reel	R16-08-SC
-10	5/8"	0.952"	4,000	16,000	0.42	4"	25', 50', 100' Coils, 164' 1 PC Reel	R16-10-SC
-12	3/4"	1.11"	4,000	16,000	0.54	4.75"	25', 50', 100' Coils, 164' 1 PC Reel	R16-12-SC
-16	1"	1.40"	3,000	12,000	0.82	6"	25', 50', 100' Coils, 164' 1 PC Reel	R16-16-SC



INNER TUBE:
Seamless oil resistant
synthetic rubber



REINFORCEMENT:
2 high tensile steel
wire braid



OUTER TUBE:
Black wrapped, oil, weather
and abrasion resistant
synthetic rubber



SAFETY FACTOR: 4:1



TEMPERATURE RANGE:
-40°C (-40°F) to
+100°C (+212°F);
Intermittent service:
+120°C (+248°F);
Max. temperature
recommended for
hydraulic fluids: +70°C
(+158°F); Max. temperature
recommended for air:
+60°C (+140°F)



APPLICATION:
Petroleum base
hydraulic fluids



COUPLINGS:

- BF21 Series
- BW23 Series
- CS "Weatherhead U"
Series Interchange
- MA "Gates Global Crimp"
Series Interchange
- A "Aeroquip 1A/
Eaton Z" Series
Interchange



COVER:
U.S. MSHA
APPROVED

Interchanges with
Aeroquip GH781
Weatherhead H245 / H280
Parker 471TC
Gates M2T

2 - MAX JACK HIGH PRESSURE JACK HOSE



700 BAR JACK HOSE and 1/2" 8000PSI - 10.1029.

High pressure, double steel braid reinforced hydraulic hose

U.S. MSHA APPROVED



HIGH PRESSURE



DOUBLE STEEL BRAID REINFORCEMENT



DESIGNED FOR HYDRAULIC JACK APPLICATIONS



U.S. MSHA APPROVED

Part Number	Hose I.D.	Hose O.D.	Working Pressure PSI	Min. Burst Pressure PSI	Min. Bend Radius (In.)	Weight lbs/ft	Packaging
JH-04	1/4" (-4)	0.580	10,000	23,200	3.4	0.38	25', 50', 100' Coils or 250' Reels
JH-06	3/8" (-6)	0.770	10,000	20,000	4.6	0.53	25', 50', 100' Coils or 250' Reels



INNER TUBE:

Seamless oil resistant synthetic rubber



REINFORCEMENT:

2 high tensile steel wire braids



OUTER TUBE:

Black wrapped, oil, weather and abrasion resistant synthetic rubber



APPLICATION:

Hydraulic jacks



TEMPERATURE RANGE:

-40°C (-40°F) to +100°C (+212°F)
Intermittent: +120°C (+248°F)
Max. temperature recommended for water base hydraulic fluids: +70°C (+158°F)
Max. temperature recommended for air: +60°C (+140°F)



COUPLINGS:

BF21 Series
BW23 Series
CS "Weatherhead U" Series (interchange)
MA "Gates Global Crimp" Series (interchange)
A "Aeroquip 1A / Eaton Z" Series (interchange)



COVER:

U.S. MSHA APPROVED



AVAILABLE PACKAGING:

25', 50', 100' Coils
328' Reel (for -04)
250' Reel (for -06)

SAFETY FACTOR: 2.3:1 (1/4"), 2.1 (3/8")

HIGH PRESSURE HOSE

SAE 100R13 / 4SH



Hydraulics Hose



HIGH PRESSURE









FOUR STEEL WIRE SPIRAL REINFORCEMENT



PETROLEUM BASE HYDRAULIC FLUIDS



EXTRA FLEXIBLE CONSTRUCTION

Dash Size	Inside Diameter 	Outside Diameter 	Working Pressure PSI 	Burst Pressure PSI 	Weight (Lbs/Ft) 	Bend Radius 	Available Packaging	Part Number
-12	3/4"	1.21"	6,100	24,400	1.05	11"	25', 50', 100' Coils, 196' Coil	4SH-12-F
-16	1"	1.48"	6,100	24,400	1.40	13"	25', 50', 100' Coils, 196' Coil	4SH-16-F
-20	1-1/4"	1.75"	5,100	20,400	1.73	18"	25', 50', 100' Coils, 196' Coil	4SH-20-F



INNER TUBE:

Seamless oil resistant synthetic rubber



REINFORCEMENT:

4 spirals of very high tensile steel wire



OUTER TUBE:

Black wrapped, oil, weather and abrasion resistant synthetic rubber

SAFETY FACTOR: 4:1



APPLICATION:

Petroleum base hydraulic fluids



COUPLINGS:

Balflex® Multicrimp fittings series BW23



COVER:

U.S. MSHA APPROVED



TEMPERATURE RANGE:

-40°C (-40°F) to +100°C (+212°F);
Intermittent service:
+120°C (+248°F);
water base hydraulic fluids:
+70°C (+158°F)
Max. temperature recommended for air: +60°C (+140°F)

NON CONDUCTIVE HOSE

ZETAFLX NON CONDUCTIVE

DIN EN 855 R7 / SAE 100R7 / ANSI A92.2 / ISO 3949 - 10.1030.L

Medium pressure specialty hose

Available in either single or twin (siamese) for bucket truck, tree trimming, power line repair, special applications requiring conductive isolation.



TWIN (SIAMESE) LINE

SINGLE LINE



NON CONDUCTIVE



MEDIUM PRESSURE



SYNTHETIC FIBER BRAID REINFORCEMENT



PETROLEUM BASE HYDRAULIC FLUIDS



EXCELLENT ABRASION RESISTANCE

Dash Size	#	SINGLE LINE Part Number	TWIN (SIAMESE) LINE Part Number	Inside Diameter inch	Outside Diameter inch	Working Pressure PSI	Burst Pressure PSI	Minimum Bend Radius inch	Available Packaging
-2	1/8"	R7-02NC	R7-02TNC	0.13	0.32	4100	16400	1.00	25', 50', or 100' Increments
-3	3/16"	R7-03NC	R7-03TNC	0.19	0.48	3100	12400	1.00	
-4	1/4"	R7-04NC	R7-04TNC	0.25	0.64	2800	11200	1.25	
-5	5/16"	R7-05NC	R7-05TNC	0.31	0.80	2800	11200	1.75	
-6	3/8"	R7-06NC	R7-06TNC	0.38	0.95	2400	9600	2.25	
-8	1/2"	R7-08NC	R7-08TNC	0.50	1.27	2300	9200	3.00	
-10	5/8"	R7-10NC	R7-10TNC	0.63	1.60	1600	6400	4.25	
-12	3/4"	R7-12NC	R7-12TNC	0.75	1.90	1400	5600	5.50	
-16	1"	R7-16NC	R7-16TNC	1.00	2.54	1100	4400	8.00	



INNER TUBE:

Seamless oil resistant thermoplastic



REINFORCEMENT:

1 high tensile polyester braid



OUTER TUBE:

Orange, oil and weather resistant polyurethane, pin-pricked

SAFETY FACTOR: 4:1



APPLICATION:

Petroleum base hydraulic fluids



TEMPERATURE RANGE:

-40°C (-40°F) to +100°C (+212°F)
Max. temperature recommended for water base hydraulic fluids: +65°C (+149°F)



COUPLINGS:

Bafflex® 2 pc hose/ferrule with 20 series ferrules
Note: Size -2 (1/8") not included in the standards.

FEATURES:

- ✓ Non-conductive tube and cover for conductive isolation
- ✓ Lightweight and flexible
- ✓ Excellent abrasion resistance
- ✓ Designed for a wide range of special applications



AVAILABLE PACKAGING:

25', 50', or 100' Increments

SAE 100R8 OMEGAFLEX PLUS

DIN EN 855 R8 / SAE 100R8 / ISO 3949 - 10.1033.

High pressure, single aramid braid reinforced thermoplastic hydraulic hose

Typically used for lifting applications like forklifts not requiring the conductive isolation.



TWIN (SIAMESE) LINE



SINGLE LINE



HIGH
PRESSURE



HIGH PRESSURE
PERFORMANCE



ARAMID FIBER
BRAID
REINFORCEMENT



PETROLEUM BASE
HYDRAULIC FLUIDS



EXCELLENT
ABRASION
RESISTANCE

Dash Size	#	SINGLE LINE Part Number	TWIN (SIAMESE) LINE Part Number	Inside Diameter inch	Outside Diameter inch	Working Pressure PSI	Burst Pressure PSI	Minimum Bend Radius inch	Available Packaging
-3	3/16"	R8-03	R8-03TB	0.19	0.48	5100	20400	0.98	25', 50', or 100' Increments
-4	1/4"	R8-04	R8-04TB	0.25	0.57	5100	20400	1.26	
-5	5/16"	R8-05	R8-05TB	0.31	0.67	4300	17200	1.77	
-6	3/8"	R8-06	R8-06TB	0.38	0.78	4100	16400	2.17	
-8	1/2"	R8-08	R8-08TB	0.50	0.96	3600	14400	3.03	
-10	5/8"	R8-10	R8-10TB	0.63	1.14	2800	11200	4.33	
-12	3/4"	R8-12	R8-12TB	0.75	1.32	2300	9200	5.51	
-16	1"	R8-16	R8-16TB	1.00	1.57	2100	8400	7.87	



INNER TUBE:

Seamless oil resistant thermoplastic



REINFORCEMENT:

1 high tensile aramid fiber braid



OUTER TUBE:

Black, oil and weather resistant thermoplastic

SAFETY FACTOR: 4:1



APPLICATION:

Petroleum base hydraulic fluids



TEMPERATURE RANGE:

-40°C (-40°F) to +100°C (+212°F)
Max. temperature recommended for water base hydraulic fluids: +65°C (+149°F)



COUPLINGS:

Bafflex® 2-piece fittings series 23 with 20 series ferrules
Note: Size -2 (1/8") not included in the standards.

FEATURES:

- ✓ High pressure performance
- ✓ Lightweight and flexible
- ✓ Excellent abrasion resistance
- ✓ Designed for a wide range of lifting applications



AVAILABLE PACKAGING:

25', 50', or 100' Increments

BALFLON SAE 100R14

SAE 100R14



SAE 100R14

High pressure, standard wall, single steel wire reinforced hydraulic hose with smooth PTFE lining



HIGH PRESSURE



HIGH PRESSURE PERFORMANCE



SINGLE STEEL WIRE BRAID REINFORCEMENT



SMOOTH PTFE LINING



EXCELLENT ABRASION RESISTANCE

Dash Size	#	Part Number	DN	Inside Diameter inch	Outside Diameter inch	Working Pressure PSI	Burst Pressure PSI	Minimum Bend Radius inch	Weight kg/m
-2	1/8"	R14-02	-2	0.13	0.23	4000	16000	1.00	0.06
-3	3/16"	R14-03	-3	0.19	0.29	2900	11600	1.38	0.08
-4	1/4"	R14-04	-4	0.25	0.35	2600	10400	1.77	0.09
-5	5/16"	R14-05	-5	0.31	0.43	2200	8800	1.97	0.14
-6	3/8"	R14-06	-6	0.38	0.49	2000	8000	2.17	0.16
-8	1/2"	R14-08	-8	0.50	0.62	1800	7200	2.76	0.21
-10	5/8"	R14-10	-10	0.63	0.75	1500	6000	5.12	0.27
-12	3/4"	R14-12	-12	0.75	0.87	1400	5600	7.48	0.37
-16	1"	R14-16	-16	1.00	1.15	950	3800	10.63	0.49



INNER TUBE:

Seamless smooth PTFE lining



REINFORCEMENT:

1 stainless steel wire braid



OUTER TUBE:

Stainless steel wire braid

SAFETY FACTOR: 4:1



APPLICATION:

Water base, petroleum base or synthetic base hydraulic fluids, corrosive, food liquids and high temperature gases and liquids



TEMPERATURE RANGE:

-70°C (-95°F) to +260°C (+500°F)
Max. continuous operating temperature +204°C (+400°F)



COUPLINGS:

Bafflex® 2-piece fittings serie 23 with 20 serie ferrules
Note: Size -2 (1/8") not included in the standards.

FEATURES:

- ✓ High pressure performance
- ✓ Smooth PTFE lining for low friction and wide fluid compatibility
- ✓ Excellent abrasion resistance
- ✓ Corrosion resistant materials
- ✓ Designed for a wide range of industrial applications



AVAILABLE PACKAGING:

25', 50', or 100' Increments

BALFLON CONVOLUTED EXTREME FLEX SAE 100R14



Extreme Flex SAE 100R14

High pressure, single Stainless Steel wire braid reinforced PTFE hose



**HIGH
PRESSURE**



**HIGH PRESSURE
PERFORMANCE**





**SINGLE STAINLESS
STEEL WIRE BRAID
REINFORCEMENT**



**SMOOTH PTFE
LINING**



**EXCELLENT
ABRASION
RESISTANCE**

Dash Size	#	Part Number	inch SAE Dash	Inside Diameter  inch	Outside Diameter  inch	Working Pressure  PSI	Burst Pressure  PSI	Minimum Bend Radius  inch	Weight  kg/m
-4	1/4"	R14-04-CV	-4	0.26	0.45	2400	9600	0.79	0.10
-5	5/16"	R14-05-CV	-5	0.32	0.48	2000	8000	1.18	0.17
-6	3/8"	R14-06-CV	-6	0.38	0.61	1800	7200	1.18	0.20
-8	1/2"	R14-08-CV	-8	0.50	0.74	1600	6400	1.57	0.27
-10	5/8"	R14-10-CV	-10	0.63	0.87	1200	4800	1.97	0.33
-12	3/4"	R14-12-CV	-12	0.75	1.04	1100	4400	3.15	0.47
-16	1"	R14-16-CV	-16	1.00	1.30	730	2920	3.94	0.63
-20	1 1/4"	R14-20-CV	-20	1.26	1.59	660	2640	4.72	0.98
-24	1 1/2"	R14-24-CV	-24	1.54	1.85	580	2320	5.51	0.30
-32	2"	R14-32-CV	-32	2.01	2.41	530	2120	6.89	1.20



INNER TUBE:

Seamless corrugated PTFE lining



REINFORCEMENT:

1 stainless steel wire braid



OUTER TUBE:

Stainless steel wire braid

SAFETY FACTOR: 4:1



APPLICATION:

Water base, petroleum base or synthetic base hydraulic fluids, corrosive, food liquids and high temperature gases and liquids



TEMPERATURE RANGE:

-70°C (-95°F) to +260°C (+500°F)
Max. continuous operating temperature +204°C (+400°F)



COUPLINGS:

Bafflex® 2-piece fittings serie 23 with 20 serie ferrules
Note: Size -2 (1/8") not included in the standards.

FEATURES:

- ✓ High pressure performance
- ✓ Smooth PTFE lining for low friction and wide fluid compatibility
- ✓ Excellent abrasion resistance
- ✓ Corrosion resistant materials
- ✓ Designed for a wide range of industrial applications



AVAILABLE PACKAGING:

25', 50', or 100' Increments

SAE 100R5 (DOT FMVSS 106) TEXTILE COVERED HYDRAULIC HOSE



SAE J1402, DOT FMVSS 106 All (3/16" thru 5/8")

Applications: Medium Pressure Applications Hydraulics, Air, Water.

Cover: Black Textile Braid Reinforcement: One Wire Braid

Temperature: -40F to +212F (-40C to +100C)

DOT APPROVED
for Fuel and Brake Service



**MEDIUM
PRESSURE**



**UP TO
3,000 PSI**



**ONE WIRE
BRAID
REINFORCEMENT**



**VERSATILE USE:
HYDRAULICS, AIR,
WATER**



**DOT FMVSS
106 & SAE
J1402 COMPLIANT**

Part Number	Hose I.D.	Hose O.D.	Working Pressure PSI	Min. Burst Pressure PSI	Min. Bend Radius (In.)	Weight lbs/ft	Packaging
R5ST-04	3/16" (-4)	0.520	3,000	12,000	3	0.10	25', 50', 100' Coils or 250' Reels
R5ST-05	1/4" (-5)	0.580	3,000	12,000	3.4	0.11	25', 50', 100' Coils or 250' Reels
R5ST-06	5/16" (-6)	0.680	2,250	9,000	4	0.15	25', 50', 100' Coils or 250' Reels
R5ST-08	13/32" (-8)	0.770	2,000	8,000	4.6	0.20	25', 50', 100' Coils or 250' Reels
R5ST-10	1/2" (-10)	0.921	1,750	7,000	5.5	0.25	25', 50', 100' Coils or 250' Reels
R5ST-12	5/8" (-12)	1.080	1,500	6,000	6.5	0.31	25', 50', 100' Coils or 250' Reels
R5ST-16	7/8" (-16)	1.240	800	3,200	7.4	0.44	25', 50', 100' Coils or 250' Reels
R5ST-20	1-1/8" (-20)	1.500	625	2,500	9	0.53	25', 50', 100' Coils
R5ST-24	1-3/8" (-24)	1.750	500	2,000	10.5	0.61	25', 50', 100' Coils
R5ST-32	1-13/16" (-32)	2.220	350	1,400	13.25	0.85	25', 50', 100' Coils



TUBE:
Black smooth synthetic rubber



REINFORCEMENT:
One high tensile steel wire braid



COVER:
Black textile braid (abrasion and weather resistant)

SAFETY FACTOR: 4:1



APPLICATION:
Medium pressure applications hydraulics, air, water



TEMPERATURE RANGE:
-40°F to +212°F (-40°C to +100°C)



COUPLINGS:
R5 Crimp style or R5-RU Field Servicable

FEATURES:

- Meets SAE 100R5, SAE J1402, and DOT FMVSS 106 All
- DOT approved for fuel and brake service
- Textile cover for excellent abrasion resistance
- One wire braid reinforcement for strength and durability
- Versatile for hydraulics, air, and water applications
- Wide range of sizes and pressures available

SAE 100R5 (DOT FMVSS 106) TEXTILE COVERED HIGH TEMPERATURE HYDRAULIC HOSE



DOT APPROVED
for Fuel and Brake Service

SAE J1402, DOT FMVSS 106 All (3/16" thru 5/8")

Applications: Medium Pressure High Temp Hydraulics, Air, Water.

Cover: Blue Textile Braid Reinforcement: One Wire Braid

Temperature: -40°F to +300°F (-40°C to +150°C)



Part Number	Hose I.D.	Hose O.D.	Working Pressure PSI	Min. Burst Pressure PSI	Min. Bend Radius (In.)	Weight lbs/ft	Packaging
R5HT-04	3/16" (-4)	0.520	3,000	12,000	3	0.10	25', 50', 100' Coils or 250' Reels
R5HT-05	1/4" (-5)	0.580	3,000	12,000	3.4	0.11	25', 50', 100' Coils or 250' Reels
R5HT-06	5/16" (-6)	0.680	2,250	9,000	4	0.15	25', 50', 100' Coils or 250' Reels
R5HT-08	13/32" (-8)	0.770	2,000	8,000	4.6	0.20	25', 50', 100' Coils or 250' Reels
R5HT-10	1/2" (-10)	0.921	1,750	7,000	5.5	0.25	25', 50', 100' Coils or 250' Reels
R5HT-12	5/8" (-12)	1.080	1,500	6,000	6.5	0.31	25', 50', 100' Coils or 250' Reels
R5HT-16	7/8" (-16)	1.240	800	3,200	7.4	0.44	25', 50', 100' Coils or 250' Reels
R5HT-20	1-1/8" (-20)	1.500	625	2,500	9	0.53	25', 50', 100' Coils
R5HT-24	1-3/8" (-24)	1.750	500	2,000	10.5	0.61	25', 50', 100' Coils
R5HT-32	1-13/16" (-32)	2.220	350	1,400	13.2	0.85	25', 50', 100' Coils



TUBE:
Black smooth synthetic rubber



REINFORCEMENT:
One high tensile steel wire braid

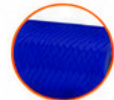

COVER:
Blue textile braid (abrasion and weather resistant)

SAFETY FACTOR: 4:1



APPLICATION:
Medium pressure high temperature hydraulics, air, water



TEMPERATURE RANGE:
-40°F to +300°F (-40°C to +150°C)



COUPLINGS:
R5 Crimp style or R5-RU Field Servicable

FEATURES:

- Meets SAE 100R5, SAE J1402, and DOT FMVSS 106 All
- DOT approved for fuel and brake service
- Textile cover for excellent abrasion resistance
- One wire braid reinforcement for strength and durability
- Versatile for hydraulics, air, and water applications
- Wide range of sizes and pressures available

Hydraulics Hose

MALE NPT PIPE RIGID - MP



HOSE		THREAD		PART NUMBER			
I.D. (INCH)	Dash Size	NPTF (INCH)	Dash Size	Parker 43 Interchange	Weatherhead U Interchange	Gates Mega Crimp Interchange	Eaton/Danfoss 1AA/Z Interchange
1/4"	-04	1/8"-27	-02	BF2104-02MP	CS01-4X2	MA01-4X2	A01-4X2
1/4"	-04	1/4"-18	-04	BF2104-04MP	CS01-4X4	MA01-4X4	A01-4X4
1/4"	-04	3/8"-18	-06	BF2104-06MP	CS01-4X6	MA01-4X6	A01-4X6
1/4"	-04	1/2"-14	-08	BF2104-08MP	CS01-4X8	MA01-4X8	A01-4X8
3/8"	-06	1/4"-18	-04	BF2106-04MP	CS01-6X4	MA01-6X4	A01-6X4
3/8"	-06	3/8"-18	-06	BF2106-06MP	CS01-6X6	MA01-6X6	A01-6X6
3/8"	-06	1/2"-14	-08	BF2106-08MP	CS01-6X8	MA01-6X8	A01-6X8
1/2"	-08	3/8"-18	-06	BF2108-06MP	CS01-8X6	MA01-8X6	A01-8X6
1/2"	-08	1/2"-14	-08	BF2108-08MP	CS01-8X8	MA01-8X8	A01-8X8
1/2"	-08	3/4"-14	-12	BF2108-12MP	CS01-8X12	MA01-8X12	A01-8X12
5/8"	-10	1/2"-14	-08	BF2110-08MP	CS01-10X8	MA01-10X8	A01-10X8
5/8"	-10	3/4"-14	-12	BF2110-12MP	CS01-10X12	MA01-10X12	A01-10X12
3/4"	-12	1/2"-14	-08	BF2112-08MP	CS01-12X8	MA01-12X8	A01-12X8
3/4"	-12	3/4"-14	-12	BF2112-12MP	CS01-12X12	MA01-12X12	A01-12X12
3/4"	-12	1"-11.5	-16	BF2112-16MP	CS01-12X16	MA01-12X16	A01-12X16
1"	-16	3/4"-14	-12	BF2116-12MP	CS01-16X12	MA01-16X12	A01-16X12
1"	-16	1"-11.5	-16	BF2116-16MP	CS01-16X16	MA01-16X16	A01-16X16

MALE NPT PIPE SWIVEL - MPX



HOSE		THREAD		PART NUMBER			
I.D. (INCH)	Dash Size	NPTF (INCH)	Dash Size	Parker 43 Interchange	Weatherhead U Interchange	Gates Mega Crimp Interchange	Eaton/Danfoss 1AA/Z Interchange
1/4"	-04	1/8"-27	-02	BF2104-02MPX	CS04-4X2	MA04-4X2	A04-4X2
1/4"	-04	1/4"-18	-04	BF2104-04MPX	CS04-4X4	MA04-4X4	A04-4X4
1/4"	-04	3/8"-18	-06	BF2104-06MPX	CS04-4X6	MA04-4X6	A04-4X6
3/8"	-06	1/4"-18	-04	BF2106-04MPX	CS04-6X4	MA04-6X4	A04-6X4
3/8"	-06	3/8"-18	-06	BF2106-06MPX	CS04-6X6	MA04-6X6	A04-6X6
3/8"	-06	1/2"-14	-08	BF2106-08MPX	CS04-6X8	MA04-6X8	A04-6X8
1/2"	-08	3/8"-18	-06	BF2108-06MPX	CS04-8X6	MA04-8X6	A04-8X6
1/2"	-08	1/2"-14	-08	BF2108-08MPX	CS04-8X8	MA04-8X8	A04-8X8
1/2"	-08	3/4"-14	-12	BF2108-12MPX	CS04-8X12	MA04-8X12	A04-8X12
5/8"	-10	1/2"-14	-08	BF2110-08MPX	CS04-10X8	MA04-10X8	A04-10X8
5/8"	-10	3/4"-14	-12	BF2110-12MPX	CS04-10X12	MA04-10X12	A04-10X12
3/4"	-12	1/2"-14	-08	BF2112-08MPX	CS04-12X8	MA04-12X8	A04-12X8
3/4"	-12	3/4"-14	-12	BF2112-12MPX	CS04-12X12	MA04-12X12	A04-12X12
1"	-16	1"-11.5	-16	BF2116-16MPX	CS04-16X16	MA04-16X16	A04-16X16

Braided Hose Fittings

MALE NPT PIPE SWIVEL 90° - MPX90



HOSE		THREAD		PART NUMBER			
I.D. (INCH)	Dash Size	NPTF (INCH)	Dash Size	Parker 43 Interchange	Weatherhead U Interchange	Gates Mega Crimp Interchange	Eaton/Danfoss 1AA/Z Interchange
1/4"	-04	1/8"-27	-02	BF2104-02MPX90	CS14-4X2	MA14-4X2	A14-4X2
1/4"	-04	1/4"-18	-04	BF2104-04MPX90	CS14-4X4	MA14-4X4	A14-4X4
1/4"	-04	3/8"-18	-06	BF2104-06MPX90	CS14-4X6	MA14-4X6	A14-4X6
3/8"	-06	1/4"-18	-04	BF2106-04MPX90	CS14-6X4	MA14-6X4	A14-6X4
3/8"	-06	3/8"-18	-06	BF2106-06MPX90	CS14-6X6	MA14-6X6	A14-6X6
3/8"	-06	1/2"-14	-08	BF2106-08MPX90	CS14-6X8	MA14-6X8	A14-6X8
1/2"	-08	3/8"-18	-06	BF2108-06MPX90	CS14-8X6	MA14-8X6	A14-8X6
1/2"	-08	1/2"-14	-08	BF2108-08MPX90	CS14-8X8	MA14-8X8	A14-8X8
3/4"	-12	3/4"-14	-12	BF2112-12MPX90	CS14-12X12	MA14-12X12	A14-12X12
1"	-16	1"-11.5	-16	BF2116-16MPX90	CS14-16X16	MA14-16X16	A14-16X16

FEMALE NPT PIPE SWIVEL - FPX



HOSE		THREAD		PART NUMBER			
I.D. (INCH)	Dash Size	NPTF (INCH)	Dash Size	Parker 43 Interchange	Weatherhead U Interchange	Gates Mega Crimp Interchange	Eaton/Danfoss 1AA/Z Interchange
1/4"	-04	1/8"-27	-02	BF2104-02FPX	CS05-4X2	MA05-4X2	A05-4X2
1/4"	-04	1/4"-18	-04	BF2104-04FPX	CS05-4X4	MA05-4X4	A05-4X4
1/4"	-04	3/8"-18	-06	BF2104-06FPX	CS05-4X6	MA05-4X6	A05-4X6
3/8"	-06	3/8"-18	-06	BF2106-06FPX	CS05-6X6	MA05-6X6	A05-6X6
3/8"	-06	1/2"-14	-08	BF2106-08FPX	CS05-6X8	MA05-6X8	A05-6X8
1/2"	-08	1/2"-14	-08	BF2108-08FPX	CS05-8X8	MA05-8X8	A05-8X8
3/4"	-12	3/4"-14	-12	BF2112-12FPX	CS05-12X12	MA05-12X12	A05-12X12
1"	-16	1"-11.5	-16	BF2116-16FPX	CS05-16X16	MA05-16X16	A05-16X16

MALE SAE O'RING BOSS RIGID - RA



HOSE		THREAD		PART NUMBER			
I.D. (INCH)	Dash Size	O'Ring Boss (INCH)	Dash Size	Parker 43 Interchange	Weatherhead U Interchange	Gates Mega Crimp Interchange	Eaton/Danfoss 1AA/Z Interchange
1/4"	-04	7/16"-20	-04	BF2104-04RA	CS11-4X4	MA11-4X4	A11-4X4
1/4"	-04	9/16"-18	-06	BF2104-06RA	CS11-4X6	MA11-4X6	A11-4X6
3/8"	-06	9/16"-18	-06	BF2106-06RA	CS11-6X6	MA11-6X6	A11-6X6
3/8"	-06	3/4"-16	-08	BF2106-08RA	CS11-6X8	MA11-6X8	A11-6X8
1/2"	-08	3/4"-16	-08	BF2108-08RA	CS11-8X8	MA11-8X8	A11-8X8
1/2"	-08	7/8"-14	-10	BF2108-10RA	CS11-8X10	MA11-8X10	A11-8X10
1/2"	-08	1-1/16"-12	-12	BF2108-12RA	CS11-8X12	MA11-8X12	A11-8X12
5/8"	-10	7/8"-14	-10	BF2110-10RA	CS11-10X10	MA11-10X10	A11-10X10
5/8"	-10	1-1/16"-12	-12	BF2110-12RA	CS11-10X12	MA11-10X12	A11-10X12
3/4"	-12	1-1/16"-12	-12	BF2112-12RA	CS11-12X12	MA11-12X12	A11-12X12
3/4"	-12	1-5/16"-12	-16	BF2112-16RA	CS11-12X16	MA11-12X16	A11-12X16
1"	-16	1-5/16"-12	-16	BF2116-16RA	CS11-16X16	MA11-16X16	A11-16X16

MALE SAE O'RING BOSS SWIVEL - RAX



HOSE		THREAD		PART NUMBER			
I.D. (INCH)	Dash Size	O'Ring Boss (INCH)	Dash Size	Parker 43 Interchange	Weatherhead U Interchange	Gates Mega Crimp Interchange	Eaton/Danfoss 1AA/Z Interchange
1/4"	-04	7/16"-20	-04	BF2104-04RAX	CS12-4X4	MA12-4X4	A12-4X4
1/4"	-04	9/16"-18	-06	BF2104-06RAX			
3/8"	-06	9/16"-18	-06	BF2106-06RAX	CS12-6X6	MA12-6X6	A12-6X6
3/8"	-06	3/4"-16	-08	BF2106-08RAX	CS12-6X8	MA12-6X8	A12-6X8
1/2"	-08	3/4"-16	-08	BF2108-08RAX	CS12-8X8	MA12-8X8	A12-8X8
1/2"	-08	7/8"-14	-10	BF2108-10RAX	CS12-8X10	MA12-8X10	A12-8X10
1/2"	-08	1-1/16"-12	-12	BF2108-12RAX			
5/8"	-10	7/8"-14	-10	BF2110-10RAX			
5/8"	-10	1-1/16"-12	-12	BF2110-12RAX			
3/4"	-12	1-1/16"-12	-12	BF2112-12RAX	CS12-12X12	MA12-12X12	A12-12X12
3/4"	-12	1-5/16"-12	-16	BF2112-16RAX			
1"	-16	1-5/16"-12	-16	BF2116-16RAX	CS12-16X16	MA12-16X16	A12-16X16

MALE SAE O'RING BOSS SWIVEL 90° - RAX90



HOSE		THREAD		PART NUMBER			
I.D. (INCH)	Dash Size	O'Ring Boss (INCH)	Dash Size	Parker 43 Interchange	Weatherhead U Interchange	Gates Mega Crimp Interchange	Eaton/Danfoss 1AA/Z Interchange
3/8"	-06	9/16"-18	-06	BF2106-06RAX	CS15-6X6	MA15-6X6	A15-6X6
3/8"	-06	3/4"-16	-08	BF2106-08RAX	CS15-6X8	MA15-6X8	A15-6X8
1/2"	-08	3/4"-16	-08	BF2108-08RAX	CS15-8X8	MA15-8X8	A15-8X8
1/2"	-08	7/8"-14	-10	BF2108-10RAX	CS15-8X10	MA15-8X10	A15-8X10
3/4"	-12	1-1/16"-12	-12	BF2112-12RAX	CS15-12X12	MA15-12X12	A15-12X12
1"	-16	1-5/16"-12	-16		CS15-16X16	MA15-16X16	A15-16X16

MALE JIC FLARE RIGID - MJ



HOSE		THREAD		PART NUMBER			
I.D. (INCH)	Dash Size	JIC (INCH)	Dash Size	Parker 43 Interchange	Weatherhead U Interchange	Gates Mega Crimp Interchange	Eaton/Danfoss 1AA/Z Interchange
1/4"	-04	7/16"-20	-04	BF2104-04MJ	CS08-4X4	MA08-4X4	A08-4X4
1/4"	-04	1/2"-20	-05	BF2104-05MJ	CS08-4X5	MA08-4X5	A08-4X5
1/4"	-04	9/16"-18	-06	BF2104-06MJ	CS08-4X6	MA08-4X6	A08-4X6
3/8"	-06	9/16"-18	-06	BF2106-06MJ	CS08-6X6	MA08-6X6	A08-6X6
3/8"	-06	3/4"-16	-08	BF2106-08MJ	CS08-6X8	MA08-6X8	A08-6X8
3/8"	-06	7/8"-14	-10	BF2106-10MJ	CS08-6X10	MA08-6X10	A08-6X10
1/2"	-08	9/16"-18	-06	BF2108-06MJ			
1/2"	-08	3/4"-16	-08	BF2108-08MJ	CS08-8X8	MA08-8X8	A08-8X8
1/2"	-08	7/8"-14	-10	BF2108-10MJ	CS08-8X10	MA08-8X10	A08-8X10
1/2"	-08	1-1/16"-12	-12	BF2108-12MJ	CS08-8X12	MA08-8X12	A08-8X12
5/8"	-10	3/4"-16	-08	BF2110-08MJ	CS08-10X8	MA08-10X8	A08-10X8
5/8"	-10	7/8"-14	-10	BF2110-10MJ	CS08-10X10	MA08-10X10	A08-10X10
5/8"	-10	1-1/16"-12	-12	BF2110-12MJ	CS08-10X12	MA08-10X12	A08-10X12
3/4"	-12	7/8"-14	-10	BF2112-10MJ			
3/4"	-12	1-1/16"-12	-12	BF2112-12MJ	CS08-12X12	MA08-12X12	A08-12X12
3/4"	-12	1-5/16"-12	-16	BF2112-16MJ	CS08-12X16	MA08-12X16	A08-12X16
1"	-16	1-5/16"-12	-16	BF2116-16MJ	CS08-16X16	MA08-16X16	A08-16X16

FEMALE JIC FLARE SWIVEL - FJ



Braided Hose Fittings

HOSE		THREAD		PART NUMBER			
I.D. (INCH)	Dash Size	JIC (INCH)	Dash Size	Parker 43 Interchange	Weatherhead U Interchange	Gates Mega Crimp Interchange	Eaton/Danfoss 1AA/Z Interchange
1/4"	-04	7/16"-20	-04	BF2104-04FJ	CS09-4X4	MA09-4X4	A09-4X4
1/4"	-04	1/2"-20	-05	BF2104-05FJ	CS09-4X5	MA09-4X5	A09-4X5
1/4"	-04	9/16"-18	-06	BF2104-06FJ	CS09-4X6	MA09-4X6	A09-4X6
3/8"	-06	7/16"-20	-04	BF2106-04FJ	CS09-6X4	MA09-6X4	A09-6X4
3/8"	-06	9/16"-18	-06	BF2106-06FJ	CS09-6X6	MA09-6X6	A09-6X6
3/8"	-06	3/4"-16	-08	BF2106-08FJ	CS09-6X8	MA09-6X8	A09-6X8
3/8"	-06	7/8"-14	-10	BF2106-10FJ	CS09-6X10	MA09-6X10	A09-6X10
1/2"	-08	9/16"-18	-06	BF2108-06FJ	CS09-8X6	MA09-8X6	A09-8X6
1/2"	-08	3/4"-16	-08	BF2108-08FJ	CS09-8X8	MA09-8X8	A09-8X8
1/2"	-08	7/8"-14	-10	BF2108-10FJ	CS09-8X10	MA09-8X10	A09-8X10
1/2"	-08	1-1/16"-12	-12	BF2108-12FJ	CS09-8X12	MA09-8X12	A09-8X12
5/8"	-10	3/4"-16	-08	BF2110-08FJ	CS09-10X8	MA09-10X8	A09-10X8
5/8"	-10	7/8"-14	-10	BF2110-10FJ	CS09-10X10	MA09-10X10	A09-10X10
5/8"	-10	1-1/16"-12	-12	BF2110-12FJ	CS09-10X12	MA09-10X12	A09-10X12
3/4"	-12	7/8"-14	-10	BF2112-10FJ	CS09-12X10	MA09-12X10	A09-12X10
3/4"	-12	1-1/16"-12	-12	BF2112-12FJ	CS09-12X12	MA09-12X12	A09-12X12
3/4"	-12	1-5/16"-12	-16	BF2112-16FJ	CS09-12X16	MA09-12X16	A09-12X16
1"	-16	1-1/16"-12	-12	BF2116-12FJ	CS09-16X12	MA09-16X12	A09-16X12
1"	-16	1-5/16"-12	-16	BF2116-16FJ	CS09-16X16	MA09-16X16	A09-16X16
1"	-16	1-5/8"-12	-16	GC09-16X20	CS09-16X20	MA09-16X20	A09-16X20

FEMALE JIC 45° ELBOW SWIVEL - FJ45



HOSE		THREAD		PART NUMBER			
I.D. (INCH)	Dash Size	JIC (INCH)	Dash Size	Parker 43 Interchange	Weatherhead U Interchange	Gates Mega Crimp Interchange	Eaton/Danfoss 1AA/Z Interchange
1/4"	-04	7/16"-20	-04	BF2104-04FJ45	CS25-4X4	MA25-4X4	A25-4X4
1/4"	-04	1/2"-20	-05	BF2104-05FJ45	CS25-4X5	MA25-4X5	A25-4X5
1/4"	-04	9/16"-18	-06	BF2104-06FJ45	CS25-4X6	MA25-4X6	A25-4X6
3/8"	-06	9/16"-18	-06	BF2106-06FJ45	CS25-6X6	MA25-6X6	A25-6X6
3/8"	-06	3/4"-16	-08	BF2106-08FJ45	CS25-6X8	MA25-6X8	A25-6X8
1/2"	-08	3/4"-16	-08	BF2108-08FJ45	CS25-8X8	MA25-8X8	A25-8X8
1/2"	-08	7/8"-14	-10	BF2108-10FJ45	CS25-8X10	MA25-8X10	A25-8X10
1/2"	-08	1-1/16"-12	-12	BF2108-12FJ45	CS25-8X12	MA25-8X12	A25-8X12
5/8"	-10	7/8"-14	-10	BF2110-10FJ45	CS25-10X10	MA25-10X10	A25-10X10
5/8"	-10	1-1/16"-12	-12	BF2110-12FJ45	CS25-10X12	MA25-10X12	A25-10X12
3/4"	-12	1-1/16"-12	-12	BF2112-12FJ45	CS25-12X12	MA25-12X12	A25-12X12
3/4"	-12	1-5/16"-12	-16	BF2112-16FJ45	CS25-12X16	MA25-12X16	A25-12X16
1"	-16	1-5/16"-12	-16	BF2116-16FJ45	CS25-16X16	MA25-16X16	A25-16X16

FEMALE JIC 90° SHORT ELBOW SWIVEL - FJ90S



HOSE		THREAD		PART NUMBER			
I.D. (INCH)	Dash Size	JIC (INCH)	Dash Size	Parker 43 Interchange	Weatherhead U Interchange	Gates Mega Crimp Interchange	Eaton/Danfoss 1AA/Z Interchange
1/4"	-04	7/16"-20	-04	BF2104-04FJ90S	CS17-4X4	MA17-4X4	A17-4X4
1/4"	-04	1/2"-20	-05	BF2104-05FJ90S			
1/4"	-04	9/16"-18	-06	BF2104-06FJ90S			
3/8"	-06	9/16"-18	-06	BF2106-06FJ90S	CS17-6X6	MA17-6X6	A17-6X6
3/8"	-06	3/4"-16	-08	BF2106-08FJ90S	CS17-6X8	MA17-6X8	A17-6X8
1/2"	-08	3/4"-16	-08	BF2108-08FJ90S	CS17-8X8	MA17-8X8	A17-8X8
1/2"	-08	7/8"-14	-10	BF2108-10FJ90S	CS17-8X10	MA17-8X10	A17-8X10
5/8"	-10	7/8"-14	-10	BF2110-10FJ90S			
3/4"	-12	1-1/16"-12	-12	BF2112-12FJ90S			
3/4"	-12	1-5/16"-12	-16	BF2112-16FJ90S			
1"	-16	1-5/16"-12	-16	BF2116-16FJ90S			

FEMALE JIC 90° ELBOW SWIVEL - FJ90



HOSE		THREAD		PART NUMBER			
I.D. (INCH)	Dash Size	JIC (INCH)	Dash Size	Parker 43 Interchange	Weatherhead U Interchange	Gates Mega Crimp Interchange	Eaton/Danfoss 1AA/Z Interchange
1/4"	-04	7/16"-20	-04	BF2104-04FJ90	CS26-4X4	MA26-4X4	A26-4X4
1/4"	-04	1/2"-20	-05	BF2104-05FJ90	CS26-4X5	MA26-4X5	A26-4X5
1/4"	-04	9/16"-18	-06	BF2104-06FJ90	CS26-4X6	MA26-4X6	A26-4X6
3/8"	-06	9/16"-18	-06	BF2106-06FJ90	CS26-6X6	MA26-6X6	A26-6X6
3/8"	-06	3/4"-16	-08	BF2106-08FJ90	CS26-6X8	MA26-6X8	A26-6X8
3/8"	-06	7/8"-14	-10	BF2106-10FJ90	CS26-6X10	MA26-6X10	A26-6X10
1/2"	-08	3/4"-16	-08	BF2108-08FJ90	CS26-8X8	MA26-8X8	A26-8X8
1/2"	-08	7/8"-14	-10	BF2108-10FJ90	CS26-8X10	MA26-8X10	A26-8X10
1/2"	-08	1-1/16"-12	-12	BF2108-12FJ90	CS26-8X12	MA26-8X12	A26-8X12
5/8"	-10	7/8"-14	-10	BF2110-10FJ90	CS26-10X10	MA26-10X10	A26-10X10
5/8"	-10	1-1/16"-12	-12	BF2110-12FJ90	CS26-10X12	MA26-10X12	A26-10X12
3/4"	-12	1-1/16"-12	-12	BF2112-12FJ90	CS26-12X12	MA26-12X12	A26-12X12
3/4"	-12	1-5/16"-12	-16	BF2112-16FJ90	CS26-12X16	MA26-12X16	A26-12X16
1"	-16	1-5/16"-12	-16	BF2116-16FJ90	CS26-16X16	MA26-16X16	A26-16X16

FEMALE JIC 90° LONG ELBOW SWIVEL - FJ90L



HOSE		THREAD		PART NUMBER			
I.D. (INCH)	Dash Size	JIC (INCH)	Dash Size	Parker 43 Interchange	Weatherhead U Interchange	Gates Mega Crimp Interchange	Eaton/Danfoss 1AA/Z Interchange
1/4"	-04	7/16"-20	-04	BF2104-04FJ90L	CS27-4X4	MA27-4X4	A27-4X4
1/4"	-04	1/2"-20	-05	BF2104-05FJ90L	CS27-4X5	MA27-4X5	A27-4X5
1/4"	-04	9/16"-18	-06	BF2104-06FJ90L	CS27-4X6	MA27-4X6	A27-4X6
3/8"	-06	9/16"-18	-06	BF2106-06FJ90L	CS27-6X6	MA27-6X6	A27-6X6
3/8"	-06	3/4"-16	-08	BF2106-08FJ90L	CS27-6X8	MA27-6X8	A27-6X8
3/8"	-06	7/8"-14	-10	BF2106-10FJ90L	CS27-6X10	MA27-6X10	A27-6X10
1/2"	-08	3/4"-16	-08	BF2108-08FJ90L	CS27-8X8	MA27-8X8	A27-8X8
1/2"	-08	7/8"-14	-10	BF2108-10FJ90L	CS27-8X10	MA27-8X10	A27-8X10
5/8"	-10	7/8"-14	-10	BF2110-10FJ90L	CS27-10X10	MA27-10X10	A27-10X10
3/4"	-12	1-1/16"-12	-12	BF2112-12FJ90L	CS27-12X12	MA27-12X12	A27-12X12
3/4"	-12	1-5/16"-12	-16	BF2112-16FJ90L	CS27-12X16	MA27-12X16	A27-12X16
1"	-16	1-5/16"-12	-16	BF2116-16FJ90L	CS27-16X16	MA27-16X16	A27-16X16

MALE ORFS RIGID - OFTM



HOSE		THREAD		PART NUMBER			
I.D. (INCH)	Dash Size	ORFS (INCH)	Dash Size	Parker 43 Interchange	Weatherhead U Interchange	Gates Mega Crimp Interchange	Eaton/Danfoss 1AA/Z Interchange
1/4"	-04	9/16"-18	-04	BF2104-04OFTM	CS29-4X4	MA29-4X4	A29-4X4
1/4"	-04	11/16"-18	-06	BF2104-06OFTM	CS29-4X6	MA29-4X6	A29-4X6
3/8"	-06	11/16"-18	-06	BF2106-06OFTM	CS29-6X6	MA29-6X6	A29-6X6
3/8"	-06	13/16"-16	-08	BF2106-08OFTM	CS29-6X8	MA29-6X8	A29-6X8
1/2"	-08	13/16"-16	-08	BF2108-08OFTM	CS29-8X8	MA29-8X8	A29-8X8
1/2"	-08	1"-14	-10	BF2108-10OFTM	CS29-8X10	MA29-8X10	A29-8X10
1/2"	-08	1-3/16"-12	-12	BF2108-12OFTM	CS29-8X12	MA29-8X12	A29-8X12
5/8"	-10	1"-14	-10	BF2110-10OFTM	CS29-10X10	MA29-10X10	A29-10X10
5/8"	-10	1-3/16"-12	-12	BF2110-12OFTM	CS29-10X12	MA29-10X12	A29-10X12
3/4"	-12	1-3/16"-12	-12	BF2112-12OFTM	CS29-12X12	MA29-12X12	A29-12X12
3/4"	-12	1-7/16"-12	-16	BF2112-16OFTM	CS29-12X16	MA29-12X16	A29-12X16
1"	-16	1-7/16"-12	-16	BF2116-16OFTM	CS29-16X16	MA29-16X16	A29-16X16

FEMALE ORFS SWIVEL - OFT



HOSE		THREAD		PART NUMBER			
I.D. (INCH)	Dash Size	ORFS (INCH)	Dash Size	Parker 43 Interchange	Weatherhead U Interchange	Gates Mega Crimp Interchange	Eaton/Danfoss 1AA/Z Interchange
1/4"	-04	9/16"-18	-04	BF2104-04OFT	CS30-4X4	MA30-4X4	A30-4X4
1/4"	-04	11/16"-18	-06	BF2104-06OFT	CS30-4X6	MA30-4X6	A30-4X6
3/8"	-06	9/16"-18	-04	BF2106-04OFT	CS30-6x4	MA30-6x4	A30-6x4
3/8"	-06	11/16"-18	-06	BF2106-06OFT	CS30-6X6	MA30-6X6	A30-6X6
3/8"	-06	13/16"-16	-08	BF2106-08OFT	CS30-6X8	MA30-6X8	A30-6X8
1/2"	-08	11/16"-18	-06	BF2108-06OFT	CS30-8X6	MA30-8X6	A30-8X6
1/2"	-08	13/16"-16	-08	BF2108-08OFT	CS30-8X8	MA30-8X8	A30-8X8
1/2"	-08	1"-14	-10	BF2108-10OFT	CS30-8X10	MA30-8X10	A30-8X10
1/2"	-08	1-3/16"-12	-12	BF2108-12OFT	CS30-8X12	MA30-8X12	A30-8X12
5/8"	-10	13/16"-16	-08	BF2110-08OFT	CS30-10X8	MA30-10X8	A30-10X8
5/8"	-10	1"-14	-10	BF2110-10OFT	CS30-10X10	MA30-10X10	A30-10X10
5/8"	-10	1-3/16"-12	-12	BF2110-12OFT	CS30-10X12	MA30-10X12	A30-10X12
3/4"	-12	1"-14	-10	BF2112-10OFT	CS30-12X10	MA30-12X10	A30-12X10
3/4"	-12	1-3/16"-12	-12	BF2112-12OFT	CS30-12X12	MA30-12X12	A30-12X12
3/4"	-12	1-7/16"-12	-16	BF2112-16OFT	CS30-12X16	MA30-12X16	A30-12X16
1"	-16	1-3/16"-12	-12	BF2116-12OFT	CS30-16X12	MA30-16X12	A30-16X12
1"	-16	1-7/16"-12	-16	BF2116-16OFT	CS30-16X16	MA30-16X16	A30-16X16

Braided Hose Fittings

FEMALE ORFS 45° ELBOW SWIVEL - OF45



Braided Hose Fittings

HOSE		THREAD		PART NUMBER			
I.D. (INCH)	Dash Size	ORFS (INCH)	Dash Size	Parker 43 Interchange	Weatherhead U Interchange	Gates Mega Crimp Interchange	Eaton/Danfoss 1AA/Z Interchange
1/4"	-04	9/16"-18	-04	BF2104-04OF45	CS31-4X4	MA31-4X4	A31-4X4
1/4"	-04	11/16"-18	-06	BF2104-06OF45	CS31-4X6	MA31-4X6	A31-4X6
3/8"	-06	9/16"-18	-04	BF2106-04OF45			
3/8"	-06	11/16"-18	-06	BF2106-06OF45	CS31-6X6	MA31-6X6	A31-6X6
3/8"	-06	13/16"-16	-08	BF2106-08OF45	CS31-6X8	MA31-6X8	A31-6X8
1/2"	-08	11/16"-18	-06	BF2108-06OF45	CS31-8X6	MA31-8X6	A31-8X6
1/2"	-08	13/16"-16	-08	BF2108-08OF45	CS31-8X8	MA31-8X8	A31-8X8
1/2"	-08	1"-14	-10	BF2108-10OF45	CS31-8X10	MA31-8X10	A31-8X10
1/2"	-08	1-3/16"-12	-12	BF2108-12OF45	CS31-8X12	MA31-8X12	A31-8X12
5/8"	-10	1"-14	-10	BF2110-10OF45	CS31-10X10	MA31-10X10	A31-10X10
5/8"	-10	1-3/16"-12	-12	BF2110-12OF45	CS31-10X12	MA31-10X12	A31-10X12
3/4"	-12	1-3/16"-12	-12	BF2112-12OF45	CS31-12X12	MA31-12X12	A31-12X12
3/4"	-12	1-7/16"-12	-16	BF2112-16OF45	CS31-12X16	MA31-12X16	A31-12X16
1"	-16	1-3/16"-12	-12	BF2116-12OF45			
1"	-16	1-7/16"-12	-16	BF2116-16OF45	CS31-16X16	MA31-16X16	A31-16X16

FEMALE ORFS 90° ELBOW SWIVEL - OF90



HOSE		THREAD		PART NUMBER			
I.D. (INCH)	Dash Size	ORFS (INCH)	Dash Size	Parker 43 Interchange	Weatherhead U Interchange	Gates Mega Crimp Interchange	Eaton/Danfoss 1AA/Z Interchange
1/4"	-04	9/16"-18	-04	BF2104-04OF90	CS32-4X4	MA32-4X4	A32-4X4
1/4"	-04	11/16"-18	-06	BF2104-06OF90	CS32-4X6	MA32-4X6	A32-4X6
3/8"	-06	9/16"-18	-04	BF2106-04OF90	CS32-6x4	MA32-6x4	A32-6x4
3/8"	-06	11/16"-18	-06	BF2106-06OF90	CS32-6X6	MA32-6X6	A32-6X6
3/8"	-06	13/16"-16	-08	BF2106-08OF90	CS32-6X8	MA32-6X8	A32-6X8
1/2"	-08	11/16"-18	-06	BF2108-06OF90	CS32-8X6	MA32-8X6	A32-8X6
1/2"	-08	13/16"-16	-08	BF2108-08OF90	CS32-8X8	MA32-8X8	A32-8X8
1/2"	-08	1"-14	-10	BF2108-10OF90	CS32-8X10	MA32-8X10	A32-8X10
1/2"	-08	1-3/16"-12	-12	BF2108-12OF90	CS32-8X12	MA32-8X12	A32-8X12
5/8"	-10	13/16"-16	-08	BF2110-08OF90			
5/8"	-10	1"-14	-10	BF2110-10OF90	CS32-10X10	MA32-10X10	A32-10X10
5/8"	-10	1-3/16"-12	-12	BF2110-12OF90	CS32-10X12	MA32-10X12	A32-10X12
3/4"	-12	1"-14	-10		CS32-12X10	MA32-12X10	A32-12X10
3/4"	-12	1-3/16"-12	-12	BF2112-12OF90	CS32-12X12	MA32-12X12	A32-12X12
3/4"	-12	1-7/16"-12	-16	BF2112-16OF90	CS32-12X16	MA32-12X16	A32-12X16
1"	-16	1-3/16"-12	-12	BF2116-12OF90			
1"	-16	1-7/16"-12	-16	BF2116-16OF90	CS32-16X16	MA32-16X16	A32-16X16

FEMALE ORFS 90° LONG ELBOW SWIVEL - OF90L



HOSE		THREAD		PART NUMBER			
I.D. (INCH)	Dash Size	ORFS (INCH)	Dash Size	Parker 43 Interchange	Weatherhead U Interchange	Gates Mega Crimp Interchange	Eaton/Danfoss 1AA/Z Interchange
1/4"	-04	9/16"-18	-04	BF2104-04OF90	CS33-4X4	MA33-4X4	A33-4X4
1/4"	-04	11/16"-18	-06	GC33-4X6	CS33-4X6	MA33-4X6	A33-4X6
3/8"	-06	11/16"-18	-06	BF2106-06OF90	CS33-6X6	MA33-6X6	A33-6X6
3/8"	-06	13/16"-16	-08	BF2106-08OF90	CS33-6X8	MA33-6X8	A33-6X8
1/2"	-08	13/16"-16	-08	BF2108-08OF90	CS33-8X8	MA33-8X8	A33-8X8
1/2"	-08	1"-14	-10	GC33-8X10	CS33-8X10	MA33-8X10	A33-8X10
5/8"	-10	1"-14	-10	BF2110-10OF90	CS33-10X10	MA33-10X10	A33-10X10
3/4"	-12	1-3/16"-12	-12	BF2112-12OF90	CS33-12X12	MA33-12X12	A33-12X12
1"	-16	1-7/16"-12	-16	BF2116-16OF90	CS33-16X16	MA33-16X16	A33-16X16

SAE FLANGE CODE 61 CD61 - PA



HOSE		THREAD		PART NUMBER			
I.D. (INCH)	Dash Size	Flange Size	Dash Size	Parker 43 Interchange	Weatherhead U Interchange	Gates Mega Crimp Interchange	Eaton/Danfoss 1AA/Z Interchange
1/2"	-08	1/2"	-08	BF2108-08PA	CS47-8X8	MA47-8X8	A47-8X8
1/2"	-08	3/4"	-12	BF2108-12PA	CS47-8X12	MA47-8X12	A47-8X12
5/8"	-10	5/8"	-10	BF2110-10PA			
5/8"	-10	3/4"	-12	BF2110-12PA			
3/4"	-12	3/4"	-12	BF2112-12PA	CS47-12X12	MA47-12X12	A47-12X12
3/4"	-12	1"	-16	BF2112-16PA	CS47-12X16	MA47-12X16	A47-12X16
1"	-16	1"	-16	BF2116-16PA	CS47-16X16	MA47-16X16	A47-16X16



Refer to technical section for correct selection, installation, and usage of hose and fittings prior to service.



SAE FLANGE CODE 61 45° ELBOW CD61 - PA45



HOSE		THREAD		PART NUMBER			
I.D. (INCH)	Dash Size	Flange Size	Dash Size	Parker 43 Interchange	Weatherhead U Interchange	Gates Mega Crimp Interchange	Eaton/Danfoss 1AA/Z Interchange
1/2"	-08	1/2"	-08	BF2108-08PA45	CS50-8X8	MA50-8X8	A50-8X8
1/2"	-08	3/4"	-12	BF2108-12PA45	CS50-8X12	MA50-8X12	A50-8X12
5/8"	-10	5/8"	-10	BF2110-10PA45			
3/4"	-12	3/4"	-12	BF2112-12PA45	CS50-12X12	MA50-12X12	A50-12X12
3/4"	-12	1"	-16	BF2112-16PA45	CS50-12X16	MA50-12X16	A50-12X16
1"	-16	1"	-16	BF2116-16PA45	CS50-16X16	MA50-16X16	A50-16X16

SAE FLANGE CODE 61 90° ELBOW CD61 - PA90

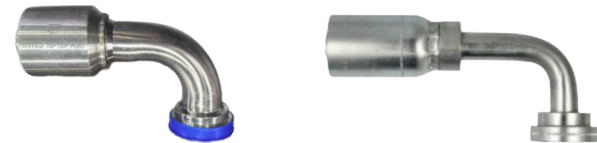

HOSE		THREAD		PART NUMBER			
I.D. (INCH)	Dash Size	Flange Size	Dash Size	Parker 43 Interchange	Weatherhead U Interchange	Gates Mega Crimp Interchange	Eaton/Danfoss 1AA/Z Interchange
1/2"	-08	1/2"	-08	BF2108-08PA90	CS53-8X8	MA53-8X8	A53-8X8
1/2"	-08	3/4"	-12	BF2108-12PA90	CS53-8X12	MA53-8X12	A53-8X12
5/8"	-10	3/4"	-12	BF2110-12PA90			
3/4"	-12	3/4"	-12	BF2112-12PA90	CS53-12X12	MA53-12X12	A53-12X12
3/4"	-12	1"	-16	BF2112-16PA90	CS53-12X16	MA53-12X16	A53-12X16
1"	-16	1"	-16	BF2116-16PA90	CS53-16X16	MA53-16X16	A53-16X16

MALE BSPP RIGID - BSPM



HOSE		THREAD		PART NUMBER			
I.D. (INCH)	Dash Size	BSPP (INCH)	Dash Size	Parker 43 Interchange	Weatherhead U Interchange	Gates Mega Crimp Interchange	Eaton/Danfoss 1AA/Z Interchange
1/4"	-04	1/8"-28	-02	BF2104-02BSPM			
1/4"	-04	1/4"-19	-04	BF2104-04BSPM	CS36-4X4	MA36-4X4	A36-4X4
1/4"	-04	3/8"-19	-06	BF2104-06BSPM			
1/4"	-04	1/2"-14	-08	BF2104-08BSPM			
3/8"	-06	1/4"-19	-04	BF2106-04BSPM			
3/8"	-06	3/8"-19	-06	BF2106-06BSPM	CS36-6X6	MA36-6X6	A36-6X6
3/8"	-06	1/2"-14	-08	BF2106-08BSPM	CS36-6X8	MA36-6X8	A36-6X8
1/2"	-08	3/8"-19	-06	BF2108-06BSPM	CS36-8X6	MA36-8X6	A36-8X6
1/2"	-08	1/2"-14	-08	BF2108-08BSPM	CS36-8X8	MA36-8X8	A36-8X8
1/2"	-08	5/8"-14	-10	BF2108-10BSPM			
1/2"	-08	3/4"-14	-12	BF2108-12BSPM			
5/8"	-10	1/2"-14	-08	BF2110-10BSPM			
3/4"	-12	3/4"-14	-12	GC36-12X12	CS36-12X12	MA36-12X12	A36-12X12

FEMALE BSPP SWIVEL - BSPXF



HOSE		THREAD		PART NUMBER			
I.D. (INCH)	Dash Size	BSPP (INCH)	Dash Size	Parker 43 Interchange	Weatherhead U Interchange	Gates Mega Crimp Interchange	Eaton/Danfoss 1AA/Z Interchange
1/4"	-04	1/8"-28	-02	BF2104-02BSPXF			
1/4"	-04	1/4"-19	-04	BF2104-04BSPXF	CS10-4X4	MA10-4X4	A10-4X4
1/4"	-04	3/8"-19	-06	BF2104-06BSPXF	CS10-4X6	MA10-4X6	A10-4X6
1/4"	-04	1/2"-14	-08	BF2104-08BSPXF			
3/8"	-06	3/8"-19	-06	BF2106-06BSPXF	CS10-6X6	MA10-6X6	A10-6X6
3/8"	-06	1/2"-14	-08	BF2106-08BSPXF	CS10-6X8	MA10-6X8	A10-6X8
1/2"	-08	1/2"-14	-08	BF2108-08BSPXF	CS10-8X8	MA10-8X8	A10-8X8
1/2"	-08	5/8"-14	-10	BF2108-10BSPXF			
5/8"	-10	5/8"-14	-10	BF2110-10BSPXF	CS10-10X10	MA10-10X10	A10-10X10
5/8"	-10	3/4"-14	-12	BF2110-12BSPXF			
3/4"	-12	3/4"-14	-12	BF2112-12BSPXF	CS10-12X12	MA10-12X12	A10-12X12
3/4"	-12	1"-11	-16	BF2112-16BSPXF			
1"	-16	1"-11	-16	BF2116-16BSPXF	CS10-16X16	MA10-16X16	A10-16X16



Refer to technical section for correct selection, installation, and usage of hose and fittings prior to service.



FEMALE BSPP 45° ELBOW SWIVEL - BSPXF45



HOSE		THREAD		PART NUMBER			
I.D. (INCH)	Dash Size	BSPP (INCH)	Dash Size	Parker 43 Interchange	Weatherhead U Interchange	Gates Mega Crimp Interchange	Eaton/Danfoss 1AA/Z Interchange
1/4"	-04	1/8"-28	-02	BF2104-02BSPXF45			
1/4"	-04	1/4"-19	-04	BF2104-04BSPXF45	CS43-4X4	MA43-4X4	A43-4X4
1/4"	-04	3/8"-19	-06	BF2104-06BSPXF45			
3/8"	-06	3/8"-19	-06	BF2106-06BSPXF45	CS43-6X6	MA43-6X6	A43-6X6
3/8"	-06	1/2"-14	-08	BF2106-08BSPXF45			
1/2"	-08	1/2"-14	-08	BF2108-08BSPXF45	CS43-8X8	MA43-8X8	A43-8X8
1/2"	-08	5/8"-14	-10	BF2108-10BSPXF45			
5/8"	-10	5/8"-14	-10	BF2110-10BSPXF45			
5/8"	-10	3/4"-14	-12	BF2110-12BSPXF45			
3/4"	-12	3/4"-14	-12	BF2112-12BSPXF45	CS43-12X12	MA43-12X12	A43-12X12
3/4"	-12	1"-11	-16	BF2112-16BSPXF45			
1"	-16	1"-11	-16	BF2116-16BSPXF45			

FEMALE BSPP 90° ELBOW SWIVEL - BSPXF90



HOSE		THREAD		PART NUMBER			
I.D. (INCH)	Dash Size	BSPP (INCH)	Dash Size	Parker 43 Interchange	Weatherhead U Interchange	Gates Mega Crimp Interchange	Eaton/Danfoss 1AA/Z Interchange
1/4"	-04	1/8"-28	-02	BF2104-02BSPXF90			
1/4"	-04	1/4"-19	-04	BF2104-04BSPXF90	CS46-4X4	MA46-4X4	A46-4X4
1/4"	-04	3/8"-19	-06	BF2104-06BSPXF90			
3/8"	-06	3/8"-19	-06	BF2106-06BSPXF90	CS46-6X6	MA46-6X6	A46-6X6
3/8"	-06	1/2"-14	-08	BF2106-08BSPXF90			
1/2"	-08	1/2"-14	-08	BF2108-08BSPXF90	CS46-8X8	MA46-8X8	A46-8X8
1/2"	-08	5/8"-14	-10	BF2108-10BSPXF90			
5/8"	-10	5/8"-14	-10	BF2110-10BSPXF90	CS46-10X10	MA46-10X10	A46-10X10
5/8"	-10	3/4"-14	-12	BF2110-12BSPXF90			
3/4"	-12	3/4"-14	-12	BF2112-12BSPXF90	CS46-12X12	MA46-12X12	A46-12X12
3/4"	-12	1"-11	-16	BF2112-16BSPXF90			
1"	-16	1"-11	-16	BF2116-16BSPXF90			

MALE DIN LIGHT RIGID - DLM



HOSE		THREAD		PART NUMBER			
I.D. (INCH)	Dash Size	DIN (Metric)	DIN Tube Size	Parker 43 Interchange	Weatherhead U Interchange	Gates Mega Crimp Interchange	Eaton/Danfoss 1AA/Z Interchange
1/4"	-04	M12x1.5	L6	BF2104-12DLM			
1/4"	-04	M14x1.5	L8	BF2104-14DLM	CS66-4X8	MA66-4X8	A66-4X8
1/4"	-04	M16x1.5	L10	BF2104-16DLM			
1/4"	-04	M18x1.5	L12	BF2104-18DLM			
3/8"	-06	M16x1.5	L10	BF2106-16DLM	CS66-6X10	MA66-6X10	A66-6X10
3/8"	-06	M18x1.5	L12	BF2106-18DLM	CS66-6X12	MA66-6X12	A66-6X12
3/8"	-06	M22x1.5	L15	BF2106-22DLM			
1/2"	-08	M18x1.5	L12	BF2108-18DLM			
1/2"	-08	M22x1.5	L15	BF2108-22DLM	CS66-8X15	MA66-8X15	A66-8X15
5/8"	-10	M26x1.5	L18	BF2110-26DLM	CS66-10X18	MA66-10X18	A66-10X18
5/8"	-10	M30x2.0	L22	BF2110-30DLM			
3/4"	-12	M30x2.0	L22	BF2112-30DLM	CS66-12X22	MA66-12X22	A66-12X22
1"	-16	M36x2.0	L28	BF2116-36DLM			

FEMALE DIN LIGHT SWIVEL- DLF



HOSE		THREAD		PART NUMBER			
I.D. (INCH)	Dash Size	DIN (Metric)	DIN Tube Size	Parker 43 Interchange	Weatherhead U Interchange	Gates Mega Crimp Interchange	Eaton/Danfoss 1AA/Z Interchange
1/4"	-04	M12x1.5	L6	BF2104-12DLF	CS37-4X6	MA37-4X6	A37-4X6
1/4"	-04	M14x1.5	L8	BF2104-14DLF	CS37-4X8	MA37-4X8	A37-4X8
1/4"	-04	M16x1.5	L10	BF2104-16DLF	CS37-4X10	MA37-4X10	A37-4X10
1/4"	-04	M18x1.5	L12	BF2104-18DLF			
3/8"	-06	M16x1.5	L10	BF2106-16DLF	CS37-6X10	MA37-6X10	A37-6X10
3/8"	-06	M18x1.5	L12	BF2106-18DLF	CS37-6X12	MA37-6X12	A37-6X12
3/8"	-06	M22x1.5	L15	BF2106-22DLF			
1/2"	-08	M22x1.5	L15	BF2108-22DLF	CS37-8X15	MA37-8X15	A37-8X15
1/2"	-08	M26x1.5	L18	BF2108-26DLF			
5/8"	-10	M26x1.5	L18	BF2110-26DLF	CS37-10X18	MA37-10X18	A37-10X18
3/4"	-12	M30x2.0	L22	BF2112-30DLF	CS37-12X22	MA37-12X22	A37-12X22
1"	-16	M36x2.0	L28	BF2116-36DLF	CS37-16x28	MA37-16x28	A37-16x28

FEMALE DIN LIGHT 45° ELBOW SWIVEL- DLF45



HOSE		THREAD		PART NUMBER			
I.D. (INCH)	Dash Size	DIN (Metric)	DIN Tube Size	Parker 43 Interchange	Weatherhead U Interchange	Gates Mega Crimp Interchange	Eaton/Danfoss 1AA/Z Interchange
1/4"	-04	M12x1.5	L6	BF2104-12DLF45			
1/4"	-04	M14x1.5	L8	BF2104-14DLF45	CS41-4X8	MA41-4X8	A41-4X8
1/4"	-04	M16x1.5	L10	BF2104-16DLF45	CS41-4X10	MA41-4X10	A41-4X10
1/4"	-04	M18x1.5	L12	BF2104-18DLF45			
3/8"	-06	M16x1.5	L10	BF2106-16DLF45	CS41-6X10	MA41-6X10	A41-6X10
3/8"	-06	M18x1.5	L12	BF2106-18DLF45	CS41-6X12	MA41-6X12	A41-6X12
1/2"	-08	M22x1.5	L15	BF2108-22DLF45	CS41-8X15	MA41-8X15	A41-8X15
1/2"	-08	M26x1.5	L18	BF2108-26DLF45			
5/8"	-10	M26x1.5	L18	BF2110-26DLF45	CS41-10X18	MA41-10X18	A41-10X18
3/4"	-12	M30x2.0	L22	BF2112-30DLF45	CS41-12X22	MA41-12X22	A41-12X22
1"	-16	M36x2.0	L28	BF2116-36DLF45			

FEMALE DIN LIGHT 90° ELBOW SWIVEL- DLF90



HOSE		THREAD		PART NUMBER			
I.D. (INCH)	Dash Size	DIN (Metric)	DIN Tube Size	Parker 43 Interchange	Weatherhead U Interchange	Gates Mega Crimp Interchange	Eaton/Danfoss 1AA/Z Interchange
1/4"	-04	M12x1.5	L6	BF2104-12DLF90			
1/4"	-04	M14x1.5	L8	BF2104-14DLF90	CS44-4X8	MA44-4X8	A44-4X8
1/4"	-04	M16x1.5	L10	BF2104-16DLF90	CS44-4X10	MA44-4X10	A44-4X10
1/4"	-04	M18x1.5	L12	BF2104-18DLF90			
3/8"	-06	M16x1.5	L10	BF2106-16DLF90	CS44-6X10	MA44-6X10	A44-6X10
3/8"	-06	M18x1.5	L12	BF2106-18DLF90	CS44-6X12	MA44-6X12	A44-6X12
1/2"	-08	M22x1.5	L15	BF2108-22DLF90	CS44-8X15	MA44-8X15	A44-8X15
1/2"	-08	M26x1.5	L18	BF2108-26DLF90			
5/8"	-10	M26x1.5	L18	BF2110-26DLF90	CS44-10X18	MA44-10X18	A44-10X18
3/4"	-12	M30x2.0	L22	BF2112-30DLF90	CS44-12X22	MA44-12X22	A44-12X22
1"	-16	M36x2.0	L28	BF2116-36DLF90			

MALE DIN HEAVY RIGID - DHM



HOSE		THREAD		PART NUMBER			
I.D. (INCH)	Dash Size	DIN (Metric)	DIN Tube Size	Parker 43 Interchange	Weatherhead U Interchange	Gates Mega Crimp Interchange	Eaton/Danfoss 1AA/Z Interchange
1/4"	-04	M14x1.5	S6	BF2104-14DHM			
1/4"	-04	M16x1.5	S8	BF2104-16DHM	CS67-4X8	MA67-4X8	A67-4X8
1/4"	-04	M18x1.5	S10	BF2104-18DHM	CS67-4X10	MA67-4X10	A67-4X10
1/4"	-04	M20x1.5	S12	BF2104-20DHM			
3/8"	-06	M18x1.5	S10	BF2106-18DHM	CS67-6X10	MA67-6X10	A67-6X10
3/8"	-06	M20x1.5	S12	BF2106-20DHM	CS67-6X12	MA67-6X12	A67-6X12
3/8"	-06	M22x1.5	S14	BF2106-22DHM	CS67-6X14	MA67-6X14	A67-6X14
3/8"	-06	M24x1.5	S16	BF2106-24DHM			
1/2"	-08	M24x1.5	S16	BF2108-24DHM	CS67-8X16	MA67-8X16	A67-8X16
5/8"	-10	M30x2.0	S20	BF2110-30DHM	CS67-10X20	MA67-10X20	A67-10X20

FEMALE DIN HEAVY SWIVEL - DHF



HOSE		THREAD		PART NUMBER			
I.D. (INCH)	Dash Size	DIN (Metric)	DIN Tube Size	Parker 43 Interchange	Weatherhead U Interchange	Gates Mega Crimp Interchange	Eaton/Danfoss 1AA/Z Interchange
1/4"	-04	M16x1.5	S8	BF2104-16DHF	CS38-4X8	MA38-4X8	A38-4X8
1/4"	-04	M18x1.5	S10	BF2104-18DHF	CS38-4X10	MA38-4X10	A38-4X10
3/8"	-06	M18x1.5	S10	BF2106-18DHF	CS38-6X10	MA38-6X10	A38-6X10
3/8"	-06	M20x1.5	S12	BF2106-20DHF	CS38-6X12	MA38-6X12	A38-6X12
3/8"	-06	M22x1.5	S14	BF2106-22DHF	CS38-6X14	MA38-6X14	A38-6X14
1/2"	-08	M24x1.5	S16	BF2108-24DHF	CS38-8X16	MA38-8X16	A38-8X16
5/8"	-10	M30x2.0	S20	GC38-10x20	CS38-10X20	MA38-10X20	A38-10X20

Braided Hose Fittings

FEMALE DIN HEAVY 45° ELBOW SWIVEL - DHF45

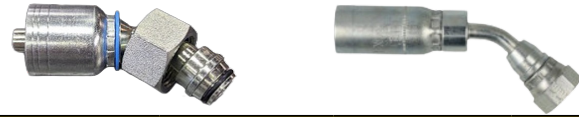

HOSE		THREAD		PART NUMBER			
I.D. (INCH)	Dash Size	DIN (Metric)	DIN Tube Size	Parker 43 Interchange	Weatherhead U Interchange	Gates Mega Crimp Interchange	Eaton/Danfoss 1AA/Z Interchange
1/4"	-04	M16x1.5	S8	BF2104-16DHF45			
1/4"	-04	M18x1.5	S10	BF2104-18DHF45	CS42-4X10	MA42-4X10	A42-4X10
3/8"	-06	M20x1.5	S12	BF2106-20DHF45	CS42-6X12	MA42-6X12	A42-6X12
3/8"	-06	M22x1.5	S14	BF2106-22DHF45			
1/2"	-08	M24x1.5	S16	BF2108-24DHF45	CS42-8X16	MA42-8X16	A42-8X16
5/8"	-10	M30x2.0	S20	GC42-10x20	CS42-10X20	MA42-10X20	A42-10X20

FEMALE DIN HEAVY 90° ELBOW SWIVEL - DHF90



HOSE		THREAD		PART NUMBER			
I.D. (INCH)	Dash Size	DIN (Metric)	DIN Tube Size	Parker 43 Interchange	Weatherhead U Interchange	Gates Mega Crimp Interchange	Eaton/Danfoss 1AA/Z Interchange
1/4"	-04	M16x1.5	S8	BF2104-16DHF90			
1/4"	-04	M18x1.5	S10	BF2104-18DHF90	CS45-4X10	MA45-4X10	A45-4X10
3/8"	-06	M18x1.5	S10	BF2106-18DHF90			
3/8"	-06	M20x1.5	S12	BF2106-20DHF90	CS45-6X12	MA45-6X12	A45-6X12
3/8"	-06	M22x1.5	S14	BF2106-22DHF90	CS45-6X14	MA45-6X14	A45-6X14
1/2"	-08	M24x1.5	S16	BF2108-24DHF90	CS45-8X16	MA45-8X16	A45-8X16
5/8"	-10	M30x2.0	S20	GC45-10x20	CS45-10X20	MA45-10X20	A45-10X20

FEMALE JIS KOMATSU SWIVEL - FX-KOMA



HOSE		THREAD	PART NUMBER			
I.D. (INCH)	Dash Size	JIS (Metric)	Parker 43 Interchange	Weatherhead U Interchange	Gates Mega Crimp Interchange	Eaton/Danfoss 1AA/Z Interchange
1/4"	-04	M14x1.5	BF2104-14FX-KOMA	CS39-4X14	MA39-4X14	A39-4X14
3/8"	-06	M16x1.5	BF2106-16FX-KOMA			
3/8"	-06	M18x1.5	BF2106-18FX-KOMA	CS39-6X18	MA39-6X18	A39-6X18
3/8"	-06	M20x1.5	BF2106-20FX-KOMA			
1/2"	-08	M22x1.5	BF2108-22FX-KOMA	CS39-8X22	MA39-8X22	A39-8X22
5/8"	-10	M24x1.5	BF2110-24FX-KOMA	CS39-10X24	MA39-10X24	A39-10X24
3/4"	-12	M30x2.0	BF2112-30FX-KOMA	CS39-12X30	MA39-12X30	A39-12X30
3/4"	-12	M33x2.0	BF2112-33FX-KOMA			
3/4"	-12	M36x2.0	BF2112-36FX-KOMA			
1"	-16	M33x2.0	BF2116-33FX-KOMA	CS39-16X33	MA39-16X33	A39-16X33
1"	-16	M36x2.0	BF2116-36FX-KOMA			

FEMALE JIS KOMATSU 90° ELBOW SWIVEL - FX-KOMA90



HOSE		THREAD	PART NUMBER
I.D. (INCH)	Dash Size	JIS (Metric)	Parker 43 Interchange
1/4"	-04	M14x1.5	BF2104-14FX-KOMA
3/8"	-06	M18x1.5	BF2106-18FX-KOMA
1/2"	-08	M22x1.5	BF2108-22FX-KOMA
5/8"	-10	M24x1.5	BF2110-24FX-KOMA
3/4"	-12	M30x2.0	BF2112-30FX-KOMA
5/8"	-10	M24x1.5	BF2110-24FX-KOMA
3/4"	-12	M30x2.0	BF2112-30FX-KOMA

FEMALE JIS BSPP SWIVEL - JIS



HOSE		THREAD	PART NUMBER			
I.D. (INCH)	Dash Size	JIS (Inch)	Parker 43 Interchange	Weatherhead U Interchange	Gates Mega Crimp Interchange	Eaton/Danfoss 1AA/Z Interchange
1/4"	-04	1/4"-19	BF2104-04JIS	CS40-4X4	MA40-4X4	A40-4X4
1/4"	-04	3/8"-19	GC40-4X6	CS40-4X6	MA40-4X6	A40-4X6
3/8"	-06	3/8"-19	BF2106-06JIS	CS40-6X6	MA40-6X6	A40-6X6
1/2"	-08	1/2"-14	BF2108-08JIS	CS40-8X8	MA40-8X8	A40-8X8
3/4"	-12	3/4"-14	BF2112-12JIS	CS40-12X12	MA40-12X12	A40-12X12
1"	-16	1"-11	BF2116-16JIS	CS40-16X16	MA40-16X16	A40-16X16



Refer to technical section for correct selection, installation, and usage of hose and fittings prior to service.



ShopHoseAndFittings.com

TOTAL HYDRAULIC & INDUSTRIAL SOLUTIONS
© 2026 Quality Hydraulics, LLC

(814) 954-5752
sales@QHHoseshop.com

2460 Commercial Blvd
State College, PA, 16801

MALE NPT PIPE RIGID - MP



HOSE		THREAD		PART NUMBER
I.D. (INCH)	Dash Size	NPTF (INCH)	Dash Size	4/2/1 Wire & Spiral Hose
3/4"	-12	1/2"-14	-08	BW2312-08MP
3/4"	-12	3/4"-14	-12	BW2312-12MP
3/4"	-12	1"-11.5	-16	BW2312-16MP
1"	-16	3/4"-14	-12	BW2316-12MP
1"	-16	1"-11.5	-16	BW2316-16MP
1"	-16	1-1/4"-11.5	-20	BW2316-20MP
1-1/4"	-20	1-1/4"-11.5	-20	BW2320-20MP
1-1/4"	-20	1-1/2"-11	-24	BW2320-24MP
1-1/2"	-24	1-1/2"-11	-24	BW2324-24MP
1-1/2"	-24	2"-11	-32	BW2324-32MP
2"	-32	2"-11	-32	BW2332-32MP

MALE NPT PIPE SWIVEL SWIVEL - MPX



HOSE		THREAD		PART NUMBER
I.D. (INCH)	Dash Size	NPTF (INCH)	Dash Size	4/2/1 Wire & Spiral Hose
3/4"	-12	3/4"-14	-12	BW2312-12MPX
1"	-16	1"-11.5	-16	BW2316-16MPX

FEMALE NPSM SWIVEL SWIVEL - FPX



HOSE		THREAD		PART NUMBER
I.D. (INCH)	Dash Size	NPTF (INCH)	Dash Size	4/2/1 Wire & Spiral Hose
3/4"	-12	3/4"-14	-12	BW2312-12FPX
1"	-16	1"-11.5	-16	BW2316-16FPX

MALE SAE O'RING BOSS RIGID - RA



HOSE		THREAD		PART NUMBER
I.D. (INCH)	Dash Size	O'Ring Boss (INCH)	Dash Size	4/2/1 Wire & Spiral Hose
3/4"	-12	1-1/16"-12	-12	BW2312-12RA
3/4"	-12	1-5/16"-12	-16	BW2312-16RA
1"	-16	1-5/16"-12	-16	BW2316-16RA

MALE JIC FLARE RIGID - MJ



HOSE		THREAD		PART NUMBER
I.D. (INCH)	Dash Size	JIC (INCH)	Dash Size	4/2/1 Wire & Spiral Hose
3/4"	-12	7/8"-14	-10	BW2312-10MJ
3/4"	-12	1-1/16"-12	-12	BW2312-12MJ
3/4"	-12	1-3/16"-12	-14	BW2312-14MJ
3/4"	-12	1-5/16"-12	-16	BW2312-16MJ
1"	-16	1-5/16"-12	-16	BW2316-16MJ
1"	-16	1-5/8"-12	-20	BW2316-20MJ
1-1/4"	-20	1-5/8"-12	-20	BW2320-20MJ
1-1/2"	-24	1-7/8"-12	-24	BW2324-24MJ
2"	-32	2-1/2"-12	-32	BW2332-32MJ

FEMALE JIC FLARE SWIVEL - FJ



HOSE		THREAD		PART NUMBER
I.D. (INCH)	Dash Size	JIC (INCH)	Dash Size	4/2/1 Wire & Spiral Hose
3/4"	-12	7/8"-14	-10	BW2312-10FJ
3/4"	-12	1-1/16"-12	-12	BW2312-12FJ
3/4"	-12	1-3/16"-12	-14	BW2312-14FJ
3/4"	-12	1-5/16"-12	-16	BW2312-16FJ
1"	-16	1-1/16"-12	-12	BW2316-12FJ
1"	-16	1-5/16"-12	-16	BW2316-16FJ
1"	-16	1-5/8"-12	-20	BW2316-20FJ
1-1/4"	-20	1-5/8"-12	-20	BW2320-20FJ
1-1/4"	-20	1-7/8"-12	-24	BW2320-24FJ
1-1/2"	-24	1-7/8"-12	-24	BW2324-24FJ
1-1/2"	-24	2-1/2"-12	-32	BW2324-32FJ
2"	-32	2-1/2"-12	-32	BW2332-32FJ

FEMALE JIC 45° ELBOW SWIVEL - FJ45



HOSE		THREAD		PART NUMBER
I.D. (INCH)	Dash Size	JIC (INCH)	Dash Size	4/2/1 Wire & Spiral Hose
3/4"	-12	1-1/16"-12	-12	BW2312-12FJ45
3/4"	-12	1-5/16"-12	-16	BW2312-16FJ45
1"	-16	1-5/16"-12	-16	BW2316-16FJ45
1"	-16	1-5/8"-12	-20	BW2316-20FJ45
1-1/4"	-20	1-5/8"-12	-20	BW2320-20FJ45
1-1/4"	-20	1-7/8"-12	-24	BW2320-24FJ45
1-1/2"	-24	1-7/8"-12	-24	BW2324-24FJ45
2"	-32	2-1/2"-12	-32	BW2332-32FJ45

FEMALE JIC 90° ELBOW SWIVEL - FJ90



HOSE		THREAD		PART NUMBER
I.D. (INCH)	Dash Size	JIC (INCH)	Dash Size	4/2/1 Wire & Spiral Hose
3/4"	-12	1-1/16"-12	-12	BW2312-12FJ90
3/4"	-12	1-5/16"-12	-16	BW2312-16FJ90
1"	-16	1-5/16"-12	-16	BW2316-16FJ90
1"	-16	1-5/8"-12	-20	BW2316-20FJ90
1-1/4"	-20	1-5/8"-12	-20	BW2320-20FJ90
1-1/4"	-20	1-7/8"-12	-24	BW2320-24FJ90
1-1/2"	-24	1-7/8"-12	-24	BW2324-24FJ90
2"	-32	2-1/2"-12	-32	BW2332-32FJ90

FEMALE JIC 90° LONG ELBOW SWIVEL - FJ90L



HOSE		THREAD		PART NUMBER
I.D. (INCH)	Dash Size	JIC (INCH)	Dash Size	4/2/1 Wire & Spiral Hose
3/4"	-12	1-1/16"-12	-12	BW2312-12FJ90L
3/4"	-12	1-5/16"-12	-16	BW2312-16FJ90L
1"	-16	1-5/16"-12	-16	BW2316-16FJ90L

MALE ORFS RIGID - OFTM



HOSE		THREAD		PART NUMBER
I.D. (INCH)	Dash Size	ORFS (INCH)	Dash Size	4/2/1 Wire & Spiral Hose
3/4"	-12	1-3/16"-12	-12	BW2312-12OFTM
3/4"	-12	1-7/16"-12	-16	BW2312-16OFTM
1"	-16	1-7/16"-12	-16	BW2316-16OFTM
1-1/4"	-20	1-11/16"-12	-20	BW2320-20OFTM
1-1/2"	-24	2"-12	-24	BW2324-24OFTM

FEMALE ORFS SWIVEL - OFT



HOSE		THREAD		PART NUMBER
I.D. (INCH)	Dash Size	ORFS (INCH)	Dash Size	4/2/1 Wire & Spiral Hose
3/4"	-12	1"-14	-10	BW2312-10OFT
3/4"	-12	1-3/16"-12	-12	BW2312-12OFT
3/4"	-12	1-7/16"-12	-16	BW2312-16OFT
1"	-16	1-3/16"-12	-12	BW2316-12OFT
1"	-16	1-7/16"-12	-16	BW2316-16OFT
1"	-16	1-11/16"-12	-20	BW2316-20OFT
1-1/4"	-20	1-11/16"-12	-20	BW2320-20OFT
1-1/4"	-20	2"-12	-24	BW2320-24OFT
1-1/2"	-24	2"-12	-24	BW2324-24OFT

FEMALE ORFS 45° ELBOW SWIVEL - OF45



HOSE		THREAD		PART NUMBER
I.D. (INCH)	Dash Size	ORFS (INCH)	Dash Size	4/2/1 Wire & Spiral Hose
3/4"	-12	1-3/16"-12	-12	BW2312-12OF45
3/4"	-12	1-7/16"-12	-16	BW2312-16OF45
1"	-16	1-3/16"-12	-12	BW2316-12OF45
1"	-16	1-7/16"-12	-16	BW2316-16OF45
1"	-16	1-11/16"-12	-20	BW2316-20OF45
1-1/4"	-20	1-11/16"-12	-20	BW2320-20OF45
1-1/4"	-20	2"-12	-24	BW2320-24OF45
1-1/2"	-24	2"-12	-24	BW2324-24OF45

FEMALE ORFS 90° ELBOW SWIVEL - OF90



HOSE		THREAD		PART NUMBER
I.D. (INCH)	Dash Size	ORFS (INCH)	Dash Size	4/2/1 Wire & Spiral Hose
3/4"	-12	1-3/16"-12	-12	BW2312-12OF90
3/4"	-12	1-7/16"-12	-16	BW2312-16OF90
1"	-16	1-3/16"-12	-12	BW2316-12OF90
1"	-16	1-7/16"-12	-16	BW2316-16OF90
1"	-16	1-11/16"-12	-20	BW2316-20OF90
1-1/4"	-20	1-11/16"-12	-20	BW2320-20OF90
1-1/4"	-20	2"-12	-24	BW2320-24OF90
1-1/2"	-24	2"-12	-24	BW2324-24OF90

FEMALE ORFS 90° LONG ELBOW SWIVEL - OF90L



HOSE		THREAD		PART NUMBER
I.D. (INCH)	Dash Size	ORFS (INCH)	Dash Size	4/2/1 Wire & Spiral Hose
3/4"	-12	1-3/16"-12	-12	BW2312-12OF90L
1"	-16	1-7/16"-12	-16	BW2316-16OF90L

SAE FLANGE CODE 61 CD61 - PA



HOSE		THREAD		PART NUMBER
I.D. (INCH)	Dash Size	Flange Size	Dash Size	4/2/1 Wire & Spiral Hose
3/4"	-12	3/4"	-12	BW2312-12PA
3/4"	-12	1"	-16	BW2312-16PA
1"	-16	1"	-16	BW2316-16PA
1"	-16	1-1/4"	-20	BW2316-20PA
1-1/4"	-20	1-1/4"	-20	BW2320-20PA
1-1/4"	-20	1-1/2"	-24	BW2320-24PA
1-1/2"	-24	1-1/4"	-20	BW2324-20PA
1-1/2"	-24	1-1/2"	-24	BW2324-24PA
1-1/2"	-24	2"	-32	BW2324-32PA
2"	-32	2"	-32	BW2332-32PA

SAE FLANGE CODE 61 45° ELBOW CD61 - PA45



HOSE		THREAD		PART NUMBER
I.D. (INCH)	Dash Size	Flange Size	Dash Size	4/2/1 Wire & Spiral Hose
3/4"	-12	3/4"	-12	BW2312-12PA45
3/4"	-12	1"	-16	BW2312-16PA45
1"	-16	1"	-16	BW2316-16PA45
1"	-16	1-1/4"	-20	BW2316-20PA45
1-1/4"	-20	1-1/4"	-20	BW2320-20PA45
1-1/4"	-20	1-1/2"	-24	BW2320-24PA45
1-1/2"	-24	1-1/2"	-24	BW2324-24PA45
1-1/2"	-24	2"	-32	BW2324-32PA45
2"	-32	2"	-32	BW2332-32PA45

SAE FLANGE CODE 61 90° ELBOW CD61 - PA90



HOSE		THREAD		PART NUMBER
I.D. (INCH)	Dash Size	Flange Size	Dash Size	4/2/1 Wire & Spiral Hose
3/4"	-12	3/4"	-12	BW2312-12PA90
3/4"	-12	1"	-16	BW2312-16PA90
1"	-16	1"	-16	BW2316-16PA90
1"	-16	1-1/4"	-20	BW2316-20PA90
1-1/4"	-20	1-1/4"	-20	BW2320-20PA90
1-1/4"	-20	1-1/2"	-24	BW2320-24PA90
1-1/2"	-24	1-1/2"	-24	BW2324-24PA90
1-1/2"	-24	2"	-32	BW2324-32PA90
2"	-32	2"	-32	BW2332-32PA90



SAE FLANGE CODE 62 CD62 - PH



HOSE		THREAD		PART NUMBER
I.D. (INCH)	Dash Size	Flange Size	Dash Size	4/2/1 Wire & Spiral Hose
3/4"	-12	3/4"	-12	BW2312-12PH
3/4"	-12	1"	-16	BW2312-16PH
1"	-16	1"	-16	BW2316-16PH
1"	-16	1-1/4"	-20	BW2316-20PH
1-1/4"	-20	1-1/4"	-20	BW2320-20PH
1-1/4"	-20	1-1/2"	-24	BW2320-24PH
1-1/2"	-24	1-1/2"	-24	BW2324-24PH
1-1/2"	-24	2"	-32	BW2324-32PH
2"	-32	2"	-32	BW2332-32PH

SAE FLANGE CODE 62 45° ELBOW CD62 - PH45



HOSE		THREAD		PART NUMBER
I.D. (INCH)	Dash Size	Flange Size	Dash Size	4/2/1 Wire & Spiral Hose
3/4"	-12	3/4"	-12	BW2312-12PH45
3/4"	-12	1"	-16	BW2312-16PH45
1"	-16	1"	-16	BW2316-16PH45
1"	-16	1-1/4"	-20	BW2316-20PH45
1-1/4"	-20	1-1/4"	-20	BW2320-20PH45
1-1/4"	-20	1-1/2"	-24	BW2320-24PH45
1-1/2"	-24	1-1/2"	-24	BW2324-24PH45
1-1/2"	-24	2"	-32	BW2324-32PH45
2"	-32	2"	-32	BW2332-32PH45

SAE FLANGE CODE 62 90° ELBOW CD62 - PH90



HOSE		THREAD		PART NUMBER
I.D. (INCH)	Dash Size	Flange Size	Dash Size	4/2/1 Wire & Spiral Hose
3/4"	-12	3/4"	-12	BW2312-12PH90
3/4"	-12	1"	-16	BW2312-16PH90
1"	-16	1"	-16	BW2316-16PH90
1"	-16	1-1/4"	-20	BW2316-20PH90
1-1/4"	-20	1-1/4"	-20	BW2320-20PH90
1-1/4"	-20	1-1/2"	-24	BW2320-24PH90
1-1/2"	-24	1-1/2"	-24	BW2324-24PH90
1-1/2"	-24	2"	-32	BW2324-32PH90
2"	-32	2"	-32	BW2332-32PH90

**SAE FLANGE CATERPILLAR
CD62C - SC**



HOSE		THREAD		PART NUMBER
I.D. (INCH)	Dash Size	Flange Size	Dash Size	4/2/1 Wire & Spiral Hose
3/4"	-12	3/4"	-12	BW2312-12SC
3/4"	-12	1"	-16	BW2312-16SC
1"	-16	1"	-16	BW2316-16SC
1"	-16	1-1/4"	-20	BW2316-20SC

**SAE FLANGE CATERPILLAR 45° ELBOW
CD62C - SC45**



HOSE		THREAD		PART NUMBER
I.D. (INCH)	Dash Size	Flange Size	Dash Size	4/2/1 Wire & Spiral Hose
3/4"	-12	3/4"	-12	BW2312-12SC45
3/4"	-12	1"	-16	BW2312-16SC45
1"	-16	1"	-16	BW2316-16SC45
1"	-16	1-1/4"	-20	BW2316-20SC45

**SAE FLANGE CATERPILLAR 90° ELBOW
CD62C - SC45**



HOSE		THREAD		PART NUMBER
I.D. (INCH)	Dash Size	Flange Size	Dash Size	4/2/1 Wire & Spiral Hose
3/4"	-12	3/4"	-12	BW2312-12SC90
3/4"	-12	1"	-16	BW2312-16SC90
1"	-16	1"	-16	BW2316-16SC90
1"	-16	1-1/4"	-20	BW2316-20SC90

MALE BSPP RIGID - BSPM



HOSE		THREAD		PART NUMBER
I.D. (INCH)	Dash Size	BSPP (INCH)	Dash Size	4/2/1 Wire & Spiral Hose
3/4"	-12	1/2"-14	-08	BW2312-08BSPM
3/4"	-12	3/4"-14	-12	BW2312-12BSPM
3/4"	-12	1"-11.5	-16	BW2312-16BSPM
1"	-16	1"-11.5	-16	BW2316-16BSPM
1"	-16	1-1/4"-11.5	-20	BW2316-20BSPM
1-1/4"	-20	1-1/4"-11.5	-20	BW2320-20BSPM
1-1/4"	-20	1-1/2"-11	-24	BW2320-24BSPM
1-1/2"	-24	1-1/2"-11	-24	BW2324-24BSPM
1-1/2"	-24	2"-11	-32	BW2324-32BSPM
2"	-32	2"-11	-32	BW2332-32BSPM

FEMALE BSPP SWIVEL - BSPXF



HOSE		THREAD		PART NUMBER
I.D. (INCH)	Dash Size	BSPP (INCH)	Dash Size	4/2/1 Wire & Spiral Hose
3/4"	-12	3/4"-14	-12	BW2312-12BSPXF
3/4"	-12	1"-11.5	-16	BW2312-16BSPXF
1"	-16	1"-11.5	-16	BW2316-16BSPXF
1"	-16	1-1/4"-11.5	-20	BW2316-20BSPXF
1-1/4"	-20	1-1/4"-11.5	-20	BW2320-20BSPXF
1-1/4"	-20	1-1/2"-11	-24	BW2320-24BSPXF
1-1/2"	-24	1-1/2"-11	-24	BW2324-24BSPXF
1-1/2"	-24	2"-11	-32	BW2324-32BSPXF
2"	-32	2"-11	-32	BW2332-32BSPXF

FEMALE BSPP 45° ELBOW SWIVEL - BSPXF45



HOSE		THREAD		PART NUMBER
I.D. (INCH)	Dash Size	BSPP (INCH)	Dash Size	4/2/1 Wire & Spiral Hose
3/4"	-12	3/4"-14	-12	BW2312-12BSPXF45
3/4"	-12	1"-11.5	-16	BW2312-16BSPXF45
1"	-16	1"-11.5	-16	BW2316-16BSPXF45
1"	-16	1-1/4"-11.5	-20	BW2316-20BSPXF45
1-1/4"	-20	1-1/4"-11.5	-20	BW2320-20BSPXF45
1-1/4"	-20	1-1/2"-11	-24	BW2320-24BSPXF45
1-1/2"	-24	1-1/2"-11	-24	BW2324-24BSPXF45
1-1/2"	-24	2"-11	-32	BW2324-32BSPXF45
2"	-32	2"-11	-32	BW2332-32BSPXF45

FEMALE BSPP 90° ELBOW SWIVEL - BSPXF90



HOSE		THREAD		PART NUMBER
I.D. (INCH)	Dash Size	BSPP (INCH)	Dash Size	4/2/1 Wire & Spiral Hose
3/4"	-12	3/4"-14	-12	BW2312-12BSPXF90
3/4"	-12	1"-11.5	-16	BW2312-16BSPXF90
1"	-16	1"-11.5	-16	BW2316-16BSPXF90
1"	-16	1-1/4"-11.5	-20	BW2316-20BSPXF90
1-1/4"	-20	1-1/4"-11.5	-20	BW2320-20BSPXF90
1-1/4"	-20	1-1/2"-11	-24	BW2320-24BSPXF90
1-1/2"	-24	1-1/2"-11	-24	BW2324-24BSPXF90
1-1/2"	-24	2"-11	-32	BW2324-32BSPXF90
2"	-32	2"-11	-32	BW2332-32BSPXF90

MALE DIN LIGHT RIGID - DLM

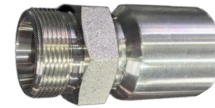

HOSE		THREAD		PART NUMBER
I.D. (INCH)	Dash Size	DIN (Metric)	DIN Tube Size	4/2/1 Wire & Spiral Hose
3/4"	-12	M30x2.0	L22	BW2312-30DLM
1"	-16	M36x2.0	L28	BW2316-36DLM
1-1/4"	-20	M45x2.0	L35	BW2320-45DLM
1-1/2"	-24	M52x2.0	L42	BW2324-52DLM

FEMALE DIN LIGHT SWIVEL - DLF



HOSE		THREAD		PART NUMBER
I.D. (INCH)	Dash Size	DIN (Metric)	DIN Tube Size	4/2/1 Wire & Spiral Hose
3/4"	-12	M30x2.0	L22	BW2312-30DLF
1"	-16	M36x2.0	L28	BW2316-36DLF
1-1/4"	-20	M45x2.0	L35	BW2320-45DLF
1-1/2"	-24	M52x2.0	L42	BW2324-52DLF

FEMALE DIN LIGHT 45° ELBOW SWIVEL - DLF45



HOSE		THREAD		PART NUMBER
I.D. (INCH)	Dash Size	DIN (Metric)	DIN Tube Size	4/2/1 Wire & Spiral Hose
3/4"	-12	M30x2.0	L22	BW2312-30DLF45
1"	-16	M36x2.0	L28	BW2316-36DLF45
1-1/4"	-20	M45x2.0	L35	BW2320-45DLF45
1-1/2"	-24	M52x2.0	L42	BW2324-52DLF45

FEMALE DIN LIGHT 90° ELBOW SWIVEL - DLF90



HOSE		THREAD		PART NUMBER
I.D. (INCH)	Dash Size	DIN (Metric)	DIN Tube Size	4/2/1 Wire & Spiral Hose
3/4"	-12	M30x2.0	L22	BW2312-30DLF90
1"	-16	M36x2.0	L28	BW2316-36DLF90
1-1/4"	-20	M45x2.0	L35	BW2320-45DLF90
1-1/2"	-24	M52x2.0	L42	BW2324-52DLF90

MALE DIN HEAVY RIGID - DHM



HOSE		THREAD		PART NUMBER
I.D. (INCH)	Dash Size	DIN (Metric)	DIN Tube Size	4/2/1 Wire & Spiral Hose
3/4"	-12	M30x2.0	S20	BW2312-30DHM
3/4"	-12	M36x2.0	S25	BW2312-36DHM
1"	-16	M36x2.0	S25	BW2316-36DHM
1-1/4"	-20	M42x2.0	S30	BW2320-42DHM
1-1/2"	-24	M52x2.0	S38	BW2324-52DHM

FEMALE DIN HEAVY SWIVEL - DHF



HOSE		THREAD		PART NUMBER
I.D. (INCH)	Dash Size	DIN (Metric)	DIN Tube Size	4/2/1 Wire & Spiral Hose
3/4"	-12	M30x2.0	S20	BW2312-30DHF
3/4"	-12	M36x2.0	S25	BW2312-36DHF
1"	-16	M36x2.0	S25	BW2316-36DHF
1-1/4"	-20	M42x2.0	S30	BW2320-42DHF
1-1/2"	-24	M52x2.0	S38	BW2324-52DHF

FEMALE DIN HEAVY 45° ELBOW SWIVEL - DHF45

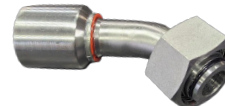

HOSE		THREAD		PART NUMBER
I.D. (INCH)	Dash Size	DIN (Metric)	DIN Tube Size	4/2/1 Wire & Spiral Hose
3/4"	-12	M30x2.0	S20	BW2312-30DHF45
3/4"	-12	M36x2.0	S25	BW2312-36DHF45
1"	-16	M36x2.0	S25	BW2316-36DHF45
1-1/4"	-20	M42x2.0	S30	BW2320-42DHF45
1-1/2"	-24	M52x2.0	S38	BW2324-52DHF45

FEMALE DIN HEAVY 90° ELBOW SWIVEL - DHF90



HOSE		THREAD		PART NUMBER
I.D. (INCH)	Dash Size	DIN (Metric)	DIN Tube Size	4/2/1 Wire & Spiral Hose
3/4"	-12	M30x2.0	S20	BW2312-30DHF90
3/4"	-12	M36x2.0	S25	BW2312-36DHF90
1"	-16	M36x2.0	S25	BW2316-36DHF90
1-1/4"	-20	M42x2.0	S30	BW2320-42DHF90
1-1/2"	-24	M52x2.0	S38	BW2324-52DHF90

FEMALE JIS KOMATSU SWIVEL - FX-KOMA



HOSE		THREAD	PART NUMBER
I.D. (INCH)	Dash Size	JIS (Metric)	4/2/1 Wire & Spiral Hose
3/4"	-12	M30x1.5	BW2312-30FX-KOMA
3/4"	-12	M33x1.5	BW2312-33FX-KOMA
3/4"	-12	M36x1.5	BW2312-36FX-KOMA
1"	-16	M33x1.5	BW2316-33FX-KOMA
1"	-16	M36x1.5	BW2316-36FX-KOMA
1-1/4"	-20	M36x1.5	BW2320-36FX-KOMA
1-1/2"	-24	M42x1.5	BW2324-42FX-KOMA

FEMALE JIS BSPP SWIVEL - JIS



HOSE		THREAD	PART NUMBER
I.D. (INCH)	Dash Size	JIS (BSPP)	4/2/1 Wire & Spiral Hose
3/4"	-12	3/4"-14	BW2312-12JIS
1"	-16	1"-11	BW2316-16JIS
1-1/4"	-20	1-1/4"-11	BW2320-20JIS



Refer to technical section for correct selection, installation, and usage of hose and fittings prior to service.





Refer to technical section for correct selection, installation, and usage of hose and fittings prior to service.



ShopHoseAndFittings.com

**TOTAL HYDRAULIC &
INDUSTRIAL SOLUTIONS**
© 2026 Quality Hydraulics, LLC

(814) 954-5752
sales@QHhoseshop.com

2460 Commercial Blvd
State College, PA, 16801

HOSE		PART NUMBER
I.D. (INCH)	Dash Size	Steel Crimp Ferrule
3/16"	-03	20-107-03
1/4"	-04	20-107-04
5/16"	-05	20-107-05
3/8"	-06	20-107-06
1/2"	-08	20-107-08
5/8"	-10	20-107-10
3/4"	-12	20-107-12
1"	-16	20-107-16

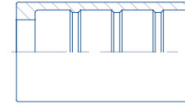

SUITABLE TO BE USED WITH:

- Texmaster 1TE
- Zetaflex R7
- OmegaFlex 100R8
- Balfon R14 & R14C

HOSE		PART NUMBER
I.D. (INCH)	Dash Size	Steel Crimp Ferrule
3/16"	-03	20-101-03
1/4"	-04	20-101-04
5/16"	-05	20-101-05
3/8"	-06	20-101-06
1/2"	-08	20-101-08
5/8"	-10	20-101-10
3/4"	-12	20-101-12
1"	-16	20-101-16

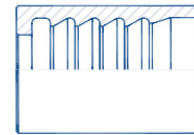

SUITABLE TO BE USED WITH:

- Forza UNO 100R1

HOSE		PART NUMBER
I.D. (INCH)	Dash Size	Steel Crimp Ferrule
1/4"	-04	20-305-04
3/8"	-06	20-305-06
1/2"	-08	20-305-08

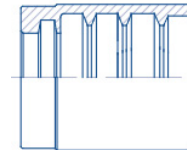

SUITABLE TO BE USED WITH:

- 100R17

HOSE		PART NUMBER
I.D. (INCH)	Dash Size	Steel Crimp Ferrule
1/4"	-04	20-302-04
5/16"	-05	20-302-05
3/8"	-06	20-302-06
1/2"	-08	20-302-08
5/8"	-10	20-302-10
3/4"	-12	20-302-12
1"	-16	20-302-16

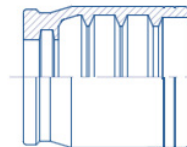

SUITABLE TO BE USED WITH:

- Forza UNO 100R1
- Forza DUO 100R2
- 100R17 (#10 and up)
- 100R16
- Jack Hose

MALE NPT PIPE RIGID - MP



HOSE		THREAD		PART NUMBER
I.D. (INCH)	Dash Size	NPTF (INCH)	Dash Size	Steel Hose Stem Only
3/16"	-03	1/8"-27	-02	23-0302-MP
3/16"	-03	1/4"-18	-04	23-0304-MP
1/4"	-04	1/8"-27	-02	23-0402-MP
1/4"	-04	1/4"-18	-04	23-0404-MP
1/4"	-04	3/8"-18	-06	23-0406-MP
1/4"	-04	1/2"-14	-08	23-0408-MP
5/16"	-05	1/4"-18	-04	23-0504-MP
5/16"	-05	3/8"-18	-06	23-0506-MP
3/8"	-06	1/4"-18	-04	23-0604-MP
3/8"	-06	3/8"-18	-06	23-0606-MP
3/8"	-06	1/2"-14	-08	23-0608-MP
1/2"	-08	3/8"-18	-06	23-0806-MP
1/2"	-08	1/2"-14	-08	23-0808-MP
1/2"	-08	3/4"-14	-12	23-0812-MP
5/8"	-10	1/2"-14	-08	23-1008-MP
5/8"	-10	3/4"-14	-12	23-1012-MP
3/4"	-12	1/2"-14	-08	23-1208-MP
3/4"	-12	3/4"-14	-12	23-1212-MP
3/4"	-12	1"-11.5	-16	23-1216-MP
1"	-16	3/4"-14	-12	23-1612-MP
1"	-16	1"-11.5	-16	23-1616-MP
1"	-16	1-1/4"-11.5	-20	23-1620-MP

FEMALE NPSM PIPE SWIVEL - FPX



HOSE		THREAD		PART NUMBER
I.D. (INCH)	Dash Size	NPTF (INCH)	Dash Size	Parker 43 Interchange
1/4"	-04	1/8"-27	-02	23-0402-MPX
1/4"	-04	1/4"-18	-04	23-0404-MPX
1/4"	-04	3/8"-18	-06	23-0406-MPX
3/8"	-06	3/8"-18	-06	23-0606-MPX
3/8"	-06	1/2"-14	-08	23-0608-MPX
1/2"	-08	1/2"-14	-08	23-0808-MPX
3/4"	-12	3/4"-14	-12	23-1212-MPX
1"	-16	1"-11.5	-16	23-1616-MPX



Refer to technical section for correct selection, installation, and usage of hose and fittings prior to service.



ShopHoseAndFittings.com

TOTAL HYDRAULIC &
INDUSTRIAL SOLUTIONS
© 2026 Quality Hydraulics, LLC

(814) 954-5752
sales@QHhoseshop.com

2460 Commercial Blvd
State College, PA, 16801

JIC FLARE MALE & FEMALE

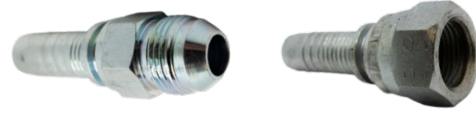

HOSE		THREAD		PART NUMBER	
I.D. (INCH)	Dash Size	JIC (INCH)	Dash Size	Male Steel Stem Only	Female Steel Stem Only
3/16"	-03	7/16"-20	-04	23-0302-MJ	23-0302-FJ
1/4"	-04	7/16"-20	-04	23-0404-MJ	23-0404-FJ
1/4"	-04	1/2"-20	-05	23-0405-MJ	23-0405-FJ
1/4"	-04	9/16"-18	-06	23-0406-MJ	23-0406-FJ
5/16"	-05	1/2"-20	-05	23-0505-MJ	23-0505-FJ
5/16"	-05	9/16"-18	-06	23-0506-MJ	23-0506-FJ
3/8"	-06	9/16"-18	-06	23-0606-MJ	23-0606-FJ
3/8"	-06	3/4"-16	-08	23-0608-MJ	23-0608-FJ
3/8"	-06	7/8"-14	-10	23-0610-MJ	23-0610-FJ
1/2"	-08	9/16"-18	-06	23-0806-MJ	23-0806-FJ
1/2"	-08	3/4"-16	-08	23-0808-MJ	23-0808-FJ
1/2"	-08	7/8"-14	-10	23-0810-MJ	23-0810-FJ
1/2"	-08	1-1/16"-12	-12	23-0812-MJ	23-0812-FJ
5/8"	-10	3/4"-16	-08	23-1008-MJ	23-1008-FJ
5/8"	-10	7/8"-14	-10	23-1010-MJ	23-1010-FJ
5/8"	-10	1-1/16"-12	-12	23-1012-MJ	23-1012-FJ
3/4"	-12	7/8"-14	-10	23-1210-MJ	23-1210-FJ
3/4"	-12	1-1/16"-12	-12	23-1212-MJ	23-1212-FJ
3/4"	-12	1-5/16"-12	-16	23-1216-MJ	23-1216-FJ
1"	-16	1-5/16"-12	-16	23-1616-MJ	23-1616-FJ
1"	-16	1-7/8"-12	-20	23-1620-MJ	23-1620-FJ

**JIC FLARE
FEMALE 45° & 90°**



HOSE		THREAD		PART NUMBER	
I.D. (INCH)	Dash Size	JIC (INCH)	Dash Size	Male Steel Stem Only	Female Steel Stem Only
3/16"	-03	7/16"-20	-04	23-0302-FJ45	23-0302-FJ90
1/4"	-04	7/16"-20	-04	23-0404-FJ45	23-0404-FJ90
1/4"	-04	1/2"-20	-05	23-0405-FJ45	23-0405-FJ90
1/4"	-04	9/16"-18	-06	23-0406-FJ45	23-0406-FJ90
5/16"	-05	1/2"-20	-05	23-0505-FJ45	23-0505-FJ90
5/16"	-05	9/16"-18	-06	23-0506-FJ45	23-0506-FJ90
3/8"	-06	9/16"-18	-06	23-0606-FJ45	23-0606-FJ90
3/8"	-06	3/4"-16	-08	23-0608-FJ45	23-0608-FJ90
3/8"	-06	7/8"-14	-10	23-0610-FJ45	23-0610-FJ90
1/2"	-08	9/16"-18	-06	23-0806-FJ45	23-0806-FJ90
1/2"	-08	3/4"-16	-08	23-0808-FJ45	23-0808-FJ90
1/2"	-08	7/8"-14	-10	23-0810-FJ45	23-0810-FJ90
1/2"	-08	1-1/16"-12	-12	23-0812-FJ45	23-0812-FJ90
5/8"	-10	3/4"-16	-08	23-1008-FJ45	23-1008-FJ90
5/8"	-10	7/8"-14	-10	23-1010-FJ45	23-1010-FJ90
5/8"	-10	1-1/16"-12	-12	23-1012-FJ45	23-1012-FJ90
3/4"	-12	7/8"-14	-10	23-1210-FJ45	23-1210-FJ90
3/4"	-12	1-1/16"-12	-12	23-1212-FJ45	23-1212-FJ90
3/4"	-12	1-5/16"-12	-16	23-1216-FJ45	23-1216-FJ90
1"	-16	1-5/16"-12	-16	23-1616-FJ45	23-1616-FJ90
1"	-16	1-7/8"-12	-20	23-1620-FJ45	23-1620-FJ90

O' RING FACE SEAL MALE & FEMALE



HOSE		THREAD		PART NUMBER	
I.D. (INCH)	Dash Size	JIC (INCH)	Dash Size	Male Steel Stem Only	Female Steel Stem Only
1/4"	-04	9/16"-18	-04	23-0404-OFTM	23-0404-OFT
1/4"	-04	11/16"-18	-06	23-0406-OFTM	23-0406-OFT
5/16"	-05	11/16"-18	-06	23-0506-OFTM	23-0506-OFT
3/8"	-06	9/16"-18	-04	23-0604-OFTM	23-0604-OFT
3/8"	-06	11/16"-18	-06	23-0606-OFTM	23-0606-OFT
3/8"	-06	13/16"-16	-08	23-0608-OFTM	23-0608-OFT
1/2"	-08	11/16"-18	-06	23-0806-OFTM	23-0806-OFT
1/2"	-08	13/16"-16	-08	23-0808-OFTM	23-0808-OFT
1/2"	-08	1"-14	-10	23-0810-OFTM	23-0810-OFT
1/2"	-08	1-3/16"-12	-12	23-0812-OFTM	23-0812-OFT
5/8"	-10	13/16"-16	-08	23-1008-OFTM	23-1008-OFT
5/8"	-10	1"-14	-10	23-1010-OFTM	23-1010-OFT
5/8"	-10	1-3/16"-12	-12	23-1012-OFTM	23-1012-OFT
3/4"	-12	1"-14	-10	23-1210-OFTM	23-1210-OFT
3/4"	-12	1-3/16"-12	-12	23-1212-OFTM	23-1212-OFT
3/4"	-12	1-7/16"-12	-16	23-1216-OFTM	23-1216-OFT
1"	-16	1-3/16"-12	-12	23-1612-OFTM	23-1612-OFT
1"	-16	1-7/16"-12	-16	23-1616-OFTM	23-1616-OFT

**O' RING FACE SEAL
FEMALE 45° & 90°**



HOSE		THREAD		PART NUMBER	
I.D. (INCH)	Dash Size	JIC (INCH)	Dash Size	Male Steel Stem Only	Female Steel Stem Only
1/4"	-04	9/16"-18	-04	23-0404-OF45	23-0404-OF90
1/4"	-04	11/16"-18	-06	23-0406-OF45	23-0406-OF90
5/16"	-05	11/16"-18	-06	23-0506-OF45	23-0506-OF90
3/8"	-06	9/16"-18	-04	23-0604-OF45	23-0604-OF90
3/8"	-06	11/16"-18	-06	23-0606-OF45	23-0606-OF90
3/8"	-06	13/16"-16	-08	23-0608-OF45	23-0608-OF90
1/2"	-08	11/16"-18	-06	23-0806-OF45	23-0806-OF90
1/2"	-08	13/16"-16	-08	23-0808-OF45	23-0808-OF90
1/2"	-08	1"-14	-10	23-0810-OF45	23-0810-OF90
1/2"	-08	1-3/16"-12	-12	23-0812-OF45	23-0812-OF90
5/8"	-10	13/16"-16	-08	23-1008-OF45	23-1008-OF90
5/8"	-10	1"-14	-10	23-1010-OF45	23-1010-OF90
5/8"	-10	1-3/16"-12	-12	23-1012-OF45	23-1012-OF90
3/4"	-12	1"-14	-10	23-1210-OF45	23-1210-OF90
3/4"	-12	1-3/16"-12	-12	23-1212-OF45	23-1212-OF90
3/4"	-12	1-7/16"-12	-16	23-1216-OF45	23-1216-OF90
1"	-16	1-3/16"-12	-12	23-1612-OF45	23-1612-OF90
1"	-16	1-7/16"-12	-16	23-1616-OF45	23-1616-OF90

BSPP MALE & FEMALE



HOSE		THREAD		PART NUMBER	
I.D. (INCH)	Dash Size	BSPP (INCH)	Dash Size	Male Steel Stem Only	Female Steel Stem Only
3/16"	-03	1/8"-28	-02	23-0302-BPM	23-0302-BSPXF
3/16"	-03	1/4"-19	-04	23-0304-BPM	23-0304-BSPXF
1/4"	-04	1/8"-28	-02	23-0402-BPM	23-0402-BSPXF
1/4"	-04	1/4"-19	-04	23-0404-BPM	23-0404-BSPXF
1/4"	-04	3/8"-19	-06	23-0406-BPM	23-0406-BSPXF
1/4"	-04	1/2"-14	-08	23-0408-BPM	23-0408-BSPXF
5/16"	-05	1/4"-19	-04	23-0504-BPM	23-0504-BSPXF
5/16"	-05	3/8"-19	-06	23-0506-BPM	23-0506-BSPXF
5/16"	-05	1/2"-14	-08	23-0508-BPM	23-0508-BSPXF
3/8"	-06	3/8"-19	-06	23-0606-BPM	23-0606-BSPXF
3/8"	-06	1/2"-14	-08	23-0608-BPM	23-0608-BSPXF
1/2"	-08	1/2"-14	-08	23-0808-BPM	23-0808-BSPXF
1/2"	-08	5/8"-14	-10	23-0810-BPM	23-0810-BSPXF
5/8"	-10	5/8"-14	-10	23-1010-BPM	23-1010-BSPXF
5/8"	-10	3/4"-14	-12	23-1012-BPM	23-1012-BSPXF
3/4"	-12	3/4"-14	-12	23-1212-BPM	23-1212-BSPXF
3/4"	-12	1"-11	-16	23-1216-BPM	23-1216-BSPXF
1"	-16	1"-11	-16	23-1616-BPM	23-1616-BSPXF



Refer to technical section for correct selection, installation, and usage of hose and fittings prior to service.



**BSPF
FEMALE 45° & 90°**



HOSE		THREAD		PART NUMBER	
I.D. (INCH)	Dash Size	BSPF (INCH)	Dash Size	Male Steel Stem Only	Female Steel Stem Only
3/16"	-03	1/8"-28	-02	23-0302-BSPXF45	23-0302-BSPXF90
3/16"	-03	1/4"-19	-04	23-0304-BSPXF45	23-0304-BSPXF90
1/4"	-04	1/8"-28	-02	23-0402-BSPXF45	23-0402-BSPXF90
1/4"	-04	1/4"-19	-04	23-0404-BSPXF45	23-0404-BSPXF90
1/4"	-04	3/8"-19	-06	23-0406-BSPXF45	23-0406-BSPXF90
1/4"	-04	1/2"-14	-08	23-0408-BSPXF45	23-0408-BSPXF90
5/16"	-05	1/4"-19	-04	23-0504-BSPXF45	23-0504-BSPXF90
5/16"	-05	3/8"-19	-06	23-0506-BSPXF45	23-0506-BSPXF90
5/16"	-05	1/2"-14	-08	23-0508-BSPXF45	23-0508-BSPXF90
3/8"	-06	3/8"-19	-06	23-0606-BSPXF45	23-0606-BSPXF90
3/8"	-06	1/2"-14	-08	23-0608-BSPXF45	23-0608-BSPXF90
1/2"	-08	1/2"-14	-08	23-0808-BSPXF45	23-0808-BSPXF90
1/2"	-08	5/8"-14	-10	23-0810-BSPXF45	23-0810-BSPXF90
5/8"	-10	5/8"-14	-10	23-1010-BSPXF45	23-1010-BSPXF90
5/8"	-10	3/4"-14	-12	23-1012-BSPXF45	23-1012-BSPXF90
3/4"	-12	3/4"-14	-12	23-1212-BSPXF45	23-1212-BSPXF90
3/4"	-12	1"-11	-16	23-1216-BSPXF45	23-1216-BSPXF90
1"	-16	1"-11	-16	23-1616-BSPXF45	23-1616-BSPXF90

**MALE NPT PIPE
RIGID - PM**



HOSE		THREAD		PART NUMBER
I.D. (INCH)	Dash Size	NPTF (INCH)	Dash Size	
3/16"	-04	1/8"-27	-02	R5-0402-PM
3/16"	-04	1/4"-18	-04	R5-0404-PM
1/4"	-05	1/4"-18	-04	R5-0504-PM
5/16"	-06	1/4"-18	-04	R5-0604-PM
5/16"	-06	3/8"-18	-06	R5-0606-PM
13/32"	-08	3/8"-18	-06	R5-0806-PM
13/32"	-08	1/2"-14	-08	R5-0808-PM
1/2"	-10	1/2"-14	-08	R5-1008-PM
5/8"	-12	3/4"-14	-12	R5-1212-PM
7/8"	-16	1"-11.5	-16	R5-1616-PM
1-1/8"	-20	1-1/4"-11.5	-20	R5-2020-PM
1-3/8"	-24	1-1/2"-11.5	-24	R5-2424-PM
1-13/16"	-32	2"-11.5	-32	R5-3232-PM

**FEMALE SAE 45° FLARE
SWIVEL - SFS**



HOSE		THREAD		PART NUMBER
I.D. (INCH)	Dash Size	NPTF (INCH)	Dash Size	
5/16"	-06	5/8"-18	-06	R5-0606-SFS
5/8"	-12	1-1/16"-14	-12	R5-1212-SFS

**FEMALE SAE 45° FLARE 90° ELBOW
SWIVEL - SFS90**

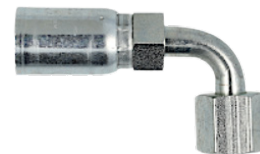

HOSE		THREAD		PART NUMBER
I.D. (INCH)	Dash Size	NPTF (INCH)	Dash Size	
5/16"	-06	5/8"-18	-06	R5-0606-SFS

100R5 Crimp Fittings

MALE JIC FLARE RIGID - JM



HOSE		THREAD		PART NUMBER
I.D. (INCH)	Dash Size	JIC (INCH)	Dash Size	
3/16"	-04	7/16"-20	-04	R5-0404-JM
1/4"	-05	1/2"-20	-05	R5-0505-JM
5/16"	-06	9/16"-18	-06	R5-0606-JM
13/32"	-08	3/4"-16	-08	R5-0808-JM
5/8"	-12	7/8"-14	-10	R5-1010-JM
5/8"	-12	1-1/16"-12	-12	R5-1212-JM
7/8"	-16	1-5/16"-12	-16	R5-1616-JM

FEMALE JIC FLARE SWIVEL - JFS



HOSE		THREAD		PART NUMBER
I.D. (INCH)	Dash Size	JIC (INCH)	Dash Size	
3/16"	-04	7/16"-20	-04	R5-0404-JFS
1/4"	-05	1/2"-20	-05	R5-0505-JFS
5/16"	-06	9/16"-18	-06	R5-0606-JFS
5/16"	-06	3/4"-16	-08	R5-0608-JFS
13/32"	-08	3/4"-16	-08	R5-0808-JFS
1/2"	-10	7/8"-14	-10	R5-0810-JFS
1/2"	-10	3/4"-16	-08	R5-1008-JFS
5/8"	-12	7/8"-14	-10	R5-1010-JFS
5/8"	-12	1-1/16"-12	-12	R5-1212-JFS
7/8"	-16	1-5/16"-12	-16	R5-1616-JFS
1-1/8"	-20	1-5/8"-12	-20	R5-2020-JFS
1-3/8"	-24	1-7/8"-12	-24	R5-2424-JFS
1-13/16"	-32	2-1/2"-12	-32	R5-3232-JFS



Refer to technical section for correct selection, installation, and usage of hose and fittings prior to service.



FEMALE JIC FLARE 45° ELBOW SWIVEL - JFS45



HOSE		THREAD		PART NUMBER
I.D. (INCH)	Dash Size	JIC (INCH)	Dash Size	
3/16"	-04	7/16"-20	-04	R5-0404-JFS45
1/4"	-05	1/2"-20	-05	R5-0505-JFS45
5/16"	-06	9/16"-18	-06	R5-0606-JFS45
13/32"	-08	3/4"-16	-08	R5-0808-JFS45
5/8"	-12	7/8"-14	-10	R5-1010-JFS45
5/8"	-12	1-1/16"-12	-12	R5-1212-JFS45
7/8"	-16	1-5/16"-12	-16	R5-1616-JFS45
1-1/8"	-20	1-5/8"-12	-20	R5-2020-JFS45
1-3/8"	-24	1-7/8"-12	-24	R5-2424-JFS45
1-13/16"	-32	2-1/2"-12	-32	R5-3232-JFS45

FEMALE JIC FLARE 90° ELBOW SWIVEL - JFS90

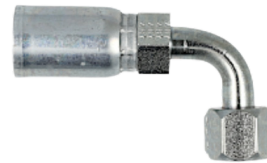

HOSE		THREAD		PART NUMBER
I.D. (INCH)	Dash Size	JIC (INCH)	Dash Size	
3/16"	-04	7/16"-20	-04	R5-0404-JFS90
1/4"	-05	1/2"-20	-05	R5-0505-JFS90
5/16"	-06	9/16"-18	-06	R5-0606-JFS90
13/32"	-08	3/4"-16	-08	R5-0808-JFS90
5/8"	-12	7/8"-14	-10	R5-1010-JFS90
5/8"	-12	1-1/16"-12	-12	R5-1212-JFS90
7/8"	-16	1-5/16"-12	-16	R5-1616-JFS90
1-1/8"	-20	1-5/8"-12	-20	R5-2020-JFS90
1-3/8"	-24	1-7/8"-12	-24	R5-2424-JFS90
1-13/16"	-32	2-1/2"-12	-32	R5-3232-JFS90

FEMALE ORFS SWIVEL - OFS



HOSE		THREAD		PART NUMBER
I.D. (INCH)	Dash Size	ORFS (INCH)	Dash Size	
3/16"	-04	9/16"-18	-04	R5-0404-OFS
5/16"	-06	11/16"-16	-06	R5-0606-OFS
13/32"	-08	13/16"-16	-08	R5-0808-OFS
5/8"	-12	1-3/16"-12	-12	R5-1212-OFS

FEMALE ORFS 45° ELBOW SWIVEL - OFS45



HOSE		THREAD		PART NUMBER
I.D. (INCH)	Dash Size	ORFS (INCH)	Dash Size	
3/16"	-04	9/16"-18	-04	R5-0404-OFS45
5/16"	-06	11/16"-16	-06	R5-0606-OFS45
13/32"	-08	13/16"-16	-08	R5-0808-OFS45

FEMALE ORFS 90° ELBOW SWIVEL - OFS90

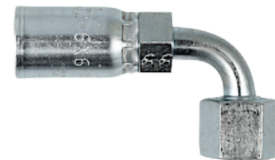

HOSE		THREAD		PART NUMBER
I.D. (INCH)	Dash Size	ORFS (INCH)	Dash Size	
3/16"	-04	9/16"-18	-04	R5-0404-OFS90
5/16"	-06	11/16"-16	-06	R5-0606-OFS90
13/32"	-08	13/16"-16	-08	R5-0808-OFS90
5/8"	-12	1-3/16"-12	-12	R5-1212-OFS90

100RS Crimp Fittings

**MALE NPT PIPE
RIGID - PM
REUSABLE/FIELD SERVICABLE**



HOSE		THREAD		PART NUMBER
I.D. (INCH)	Dash Size	NPTF (INCH)	Dash Size	Reusable/Field Servicable
3/16"	-04	1/8"-27	-02	R5-RU-0402-PM
3/16"	-04	1/4"-18	-04	R5-RU-0404-PM
5/16"	-06	3/8"-18	-06	R5-RU-0606-PM
13/32"	-08	1/2"-14	-08	R5-RU-0808-PM
1/2"	-10	1/2"-14	-08	R5-RU-1008-PM
5/8"	-12	3/4"-14	-12	R5-RU-1212-PM
7/8"	-16	1"-11.5	-16	R5-RU-1616-PM
1-1/8"	-20	1-1/4"-11.5	-20	R5-RU-2020-PM
1-3/8"	-24	1-1/2"-11.5	-24	R5-RU-2424-PM
1-13/16"	-32	2"-11.5	-32	R5-RU-3232-PM

**FEMALE SAE 45° FLARE
SWIVEL - SFS
REUSABLE/FIELD SERVICABLE**



HOSE		THREAD		PART NUMBER
I.D. (INCH)	Dash Size	NPTF (INCH)	Dash Size	Reusable/Field Servicable
5/16"	-06	5/8"-18	-06	R5-RU-0606-SFS
5/8"	-12	1-1/16"-14	-12	R5-RU-1212-SFS

**FEMALE SAE 45° FLARE 90° ELBOW
SWIVEL - SFS90
REUSABLE/FIELD SERVICABLE**



HOSE		THREAD		PART NUMBER
I.D. (INCH)	Dash Size	NPTF (INCH)	Dash Size	Reusable/Field Servicable
5/16"	-06	5/8"-18	-06	R5-RU-0606-SFS90

FEMALE JIC FLARE SWIVEL- JFS REUSABLE/FIELD SERVICABLE



HOSE		THREAD		PART NUMBER
I.D. (INCH)	Dash Size	JIC (INCH)	Dash Size	
3/16"	-04	7/16"-20	-04	R5-RU-0404-JFS
1/4"	-05	1/2"-20	-05	R5-RU-0505-JFS
5/16"	-06	9/16"-18	-06	R5-RU-0606-JFS
13/32"	-08	3/4"-16	-08	R5-RU-0808-JFS
5/8"	-12	7/8"-14	-10	R5-RU-1010-JFS
5/8"	-12	1-1/16"-12	-12	R5-RU-1212-JFS
7/8"	-16	1-5/16"-12	-16	R5-RU-1616-JFS
1-1/8"	-20	1-5/8"-12	-20	R5-RU-2020-JFS
1-3/8"	-24	1-7/8"-12	-24	R5-RU-2424-JFS
1-13/16"	-32	2-1/2"-12	-32	R5-RU-3232-JFS

FEMALE JIC FLARE 45° ELBOW SWIVEL - JFS45 REUSABLE/FIELD SERVICABLE



HOSE		THREAD		PART NUMBER
I.D. (INCH)	Dash Size	JIC (INCH)	Dash Size	
3/16"	-04	7/16"-20	-04	R5-RU-0404-JFS45
5/16"	-06	9/16"-18	-06	R5-RU-0606-JFS45
13/32"	-08	3/4"-16	-08	R5-RU-0808-JFS45
5/8"	-12	7/8"-14	-10	R5-RU-1010-JFS45
5/8"	-12	1-1/16"-12	-12	R5-RU-1212-JFS45
7/8"	-16	1-5/16"-12	-16	R5-RU-1616-JFS45

FEMALE JIC FLARE 90° ELBOW SWIVEL - JFS90 REUSABLE/FIELD SERVICABLE



HOSE		THREAD		PART NUMBER
I.D. (INCH)	Dash Size	JIC (INCH)	Dash Size	
3/16"	-04	7/16"-20	-04	R5-RU-0404-JFS90
5/16"	-06	9/16"-18	-06	R5-RU-0606-JFS90
13/32"	-08	3/4"-16	-08	R5-RU-0808-JFS90
5/8"	-12	7/8"-14	-10	R5-RU-1010-JFS90
5/8"	-12	1-1/16"-12	-12	R5-RU-1212-JFS90
7/8"	-16	1-5/16"-12	-16	R5-RU-1616-JFS90

NYLON HOSE SLEEVE

SELF-RENEWING ABRASION PROTECTION



Protec Nylon Hose Sleeve is a self-renewing, abrasion-resistant fabric sleeve that meets **MSHA** guidelines for use in underground mines. It is designed to protect hydraulic hoses and provide limited burst and containment protection to your most valuable asset, your employees.

Woven from thousands of nylon filaments, as it is scuffed and worn, its filaments frizz, forming an even thicker, protective shield. This smooth-bore sleeve is easily installed over hose, chain, cable, or springs and may be secured with nylon cable ties or band-clamps.

I.D. (INCH)	Covers Hoses	Length	Part Number
0.77"	1/4"	100' Coils, By the foot	NHS-077-FT
1.00"	3/8" & 1/2"	100' Coils, By the foot	NHS-100-FT
1.25"	5/8"	100' Coils, By the foot	NHS-125-FT
1.38"	3/4" 2 Wire	100' Coils, By the foot	NHS-138-FT
1.53"	3/4" 4 Wire	100' Coils, By the foot	NHS-153-FT
1.75"	1"	100' Coils, By the foot	NHS-175-FT
2.07"	1-1/4"	100' Coils, By the foot	NHS-207-FT
2.25"	1-1/2"	100' Coils, By the foot	NHS-225-FT
2.96"	2"	100' Coils, By the foot	NHS-296-FT
3.66"	2-1/2"	100' Coils, By the foot	NHS-366-FT

PROWRAP HOSE COIL

EXTEND THE LIFE OF YOUR HOSES & CABLES



Hose Protection

Extend the life of expensive hydraulic hoses and cables with **ProWrap Plus**. It installs easily without disconnecting any lines. Wrap individual lines or bundle hoses. Use different colors to help match and identify lines. Sizes fit from 1/4" hose to 8" bundles.

- ✔ Dual-beveled edges ease installation and reduce risk of exposed sharp edges
- ✔ Bundled hoses may exit at any point
- ✔ Tight grip prevents sliding or leap-frogging
- ✔ Manufactured from tough **HDPE** for ultimate protection against abrasive wear and crushing damage, it's resistant to chemical attack and suitable for use with all hydraulic fluids including glycol and phosphate ester based products.



ID Range	Covers Hoses	Length	Part Number				
			Black	Red	Blue	Yellow	Green
7/16" - 5/8"	1/4"	66' Boxes	PWP-16	PWP-16R	PWP-16B	PWP-16Y	PWP-16G
5/8" - 7/8"	3/8"	66' Boxes	PWP-20	PWP-20R	PWP-20B	PWP-20Y	PWP-20G
7/8" - 1-3/8"	1/2" & 5/8"	66' Boxes	PWP-25	PWP-25R	PWP-25B	PWP-25Y	PWP-25G
1-1/8" - 1-3/8"	3/4"	66' Boxes	PWP-32	PWP-32R	PWP-32B	PWP-32Y	PWP-32G
1-1/2" - 1-5/8"	1"	66' Boxes	PWP-40	PWP-40R	PWP-40B	PWP-40Y	PWP-40G
1-3/4" - 2-1/2"	1-1/4" & 1-1/2"	66' Boxes	PWP-50	PWP-50R	PWP-50B	PWP-50Y	PWP-50G
2" - 3"	2" & 2-1/2"	66' Boxes	PWP-63	PWP-63R	PWP-63B	PWP-63Y	PWP-63G
3" - 5"	Bundles	66' Boxes	PWP-90	PWP-90R	PWP-90B	PWP-90Y	PWP-90G
3-7/8" - 6"	Bundles	66' Boxes	PWP-110	PWP-110R	PWP-110B	PWP-110Y	PWP-110G

STEEL SPRING HOSE GUARD

MAXIMUM PROTECTION IN HARSH ENVIRONMENTS ///



RHINO Spring Guard is a high-strength hose protection solution designed for applications that require superior cut, crush, and impact resistance. Made from plated steel with tightly pitched coils, it helps prevent hose kinking while providing maximum protection in harsh working environments.

RHINO Spring Guard is ideal for demanding industries such as construction, mining, demolition, recycling, and forestry/logging where durable, heavy-duty hose protection is essential.

- ✓ High-strength plated steel construction for superior cut, crush, and impact resistance
- ✓ Tightly pitched coils help prevent hose kinking
- ✓ Maintains hose flexibility while providing maximum protection
- ✓ Ideal for construction, mining, demolition, recycling, and forestry/logging applications
- ✓ Extends the life of expensive hoses and reduces downtime

I.D. (INCH)	Covers Hoses	Length	Part Number
0.53"	1/4" 1 Wire Hose	20' Coils	RSP-53
0.61"	1/4" 2 Wire Hose	20' Coils	RSP-61
0.66"	3/8" 1 Wire Hose	20' Coils	RSP-66
0.75"	3/8" 2 Wire Hose	20' Coils	RSP-75
0.84"	1/2" 1&2 Wire Hose	20' Coils	RSP-84
0.99"	5/8" 1&2 Wire Hose	20' Coils	RSP-99
1.05"	3/4" 1&2 Wire Hose	20' Coils	RSP-105
1.34"	3/4" 4 Wire Hose	20' Coils	RSP-134
1.64"	1" 2/4 Wire Hose	20' Coils	RSP-164
1.88"	1-1/2" 2/4 Wire Hose	20' Coils	RSP-188

FIRE SLEEVE HOSE PROTECTOR

EXTREME HEAT PROTECTION FOR HOSES, CABLES & WIRES



Fire Sleeve is a heat resistant silicone coated fiberglass sleeving, that protects hoses, cables and wires from molten metal splash, high heat hazards and occasional exposure to flame. Used in steel plants, glass plants, foundries, cutting and welding shops, and similar extreme environments.

Fire Sleeve withstands continuous exposure up to 500°F and short-term exposure up to 2200°F. It is resistant to hydraulic fluids, fuels, and lubricating oils and remains extremely flexible and conformable through out the entire size range at working temperatures.

It also reduces energy loss and offers personnel burn protection by insulating hot oil, steam lines or pipe surfaces.

- ✓ Heat resistant silicone coated fiberglass construction
- ✓ Withstands continuous exposure up to 500°F and short-term exposure up to 2200°F
- ✓ Resistant to hydraulic fluids, fuels, and lubricating oils
- ✓ Maintains flexibility and conformability across the entire size range
- ✓ Insulates hot oil, steam lines or pipe surfaces and reduces energy loss
- ✓ Provides personnel burn protection in high temperature environments

I.D. (INCH)	Covers Hoses	Length	Part Number
0.625"	1/4"	50' Coils	PT10100-10
0.75"	3/8"	50' Coils	PT12100-10
1.00"	1/2"	50' Coils	PT16100-10
1.25"	5/8"	50' Coils	PT20100-10
1.375"	3/4"	50' Coils	PT22100-10
1.50"	1"	50' Coils	PT24100-10
1.75"	1-1/4"	50' Coils	PT28100-10
2.00"	1-1/2"	50' Coils	PT32100-10
2.25"	Bundle	50' Coils	PT36100-10
2.50"	Bundle	50' Coils	PT40100-10

Hose Protection

ALUMINUM HEAT SHIELD

HIGH TEMPERATURE PROTECTION FOR CRITICAL COMPONENTS



Protect wires, cables, hoses and fuel lines against radiant and convective heat found in engine bays and around mechanical machinery. Taking two materials that provide high heat protection and joining them to create a high temperature heat shield.

By using a **two layer design**, the outer aluminum foil layer redirect up to 90% of the radiant energy from hot steel slabs, molten metals, engine exhaust manifolds and open flames. The inner layer of fiberglass is designed for long term continuous operation temperatures of more than 400°C.

Material: Outer Layer-Aluminum Foil; Inner Layer-Fiberglass

Melting Point: 600+°C **Working Temp:** -50°C to +200°C **RoHS** Compliant

- ✓ Dual layer construction for superior heat protection
- ✓ Outer aluminum layer reflects up to 90% of radiant heat
- ✓ Inner fiberglass layer withstands continuous temps over 400°C
- ✓ Protects against radiant and convective heat, molten metal splash, and open flames
- ✓ Easy to install on hoses, cables, wires and fuel lines
- ✓ Ideal for engine bays, steel plants, foundries, welding and cutting operations

I.D. (INCH)	Covers Hoses	Length	Part Number
0.625"	1/4"	25' Coils	AFHS-10
0.75"	3/8"	25' Coils	AFHS-12
1.00"	1/2"	25' Coils	AFHS-16
1.50"	5/8" - 1"	25' Coils	AFHS-24
2.00"	1-1/4"	25' Coils	AFHS-32

HOSE PROTECTORS

DURABLE WEAR SHIELDS FOR MAXIMUM HOSE PROTECTION



Hose Protectors are durable wear shields made of an abrasion and hydrocarbon resistant material which is impervious to solvents, oils, grease and gasoline. They are highly abrasion resistant, with a wide range of operating temperatures (-40 degrees to 400 degrees F), and will protect your equipment in even the harshest of conditions. Easy installation in minutes, with no system disassembly required.

Available in three colors: black, yellow, and orange.

- ✓ Durable abrasion and hydrocarbon resistant material
- ✓ Impervious to solvents, oils, grease and gasoline
- ✓ Wide operating temperature range: -40°F to 400°F
- ✓ Protects hoses in even the harshest conditions
- ✓ Easy installation in minutes
- ✓ No system disassembly required
- ✓ Available in three colors: black, yellow, and orange
- ✓ Ideal for hoses in industrial, construction, agriculture and mobile equipment applications

Length	Part Number		
	Black	Yellow	Orange
4"	HP-04B	HP-04Y	HP-04O
6"	HP-06B	HP-06Y	HP-06O
8"	HP-08B	HP-08Y	HP-08O
10"	HP-10B	HP-10Y	HP-10O
12"	HP-12B	HP-12Y	HP-12O

Hose Protection

COLOR CODING SHRINK TUBES

QUICK IDENTIFICATION AND COLOR CODING FOR HOSE ASSEMBLIES

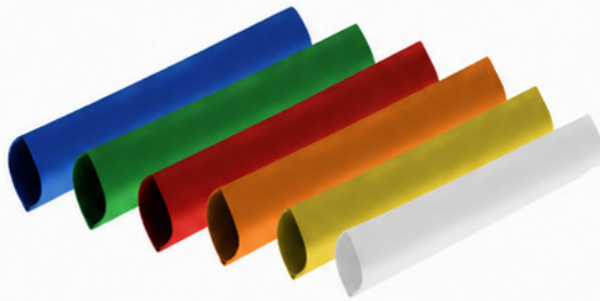

RHINO Color Coding Shrink Tubing is a highly flexible, non-adhesive lined shrink tubing solution designed for quick hose identification, wire marking, and color coding of hose assemblies. Built for general-purpose applications, it offers flame resistance, a 2:1 shrink ratio, and a wide operating temperature range from -57°F to +275°F.

Available in multiple colors, RHINO Color Coding Shrink Tubing provides a clean, durable way to improve organization, visibility, and identification across hydraulic hose assemblies.

- ✔ Highly flexible, non-adhesive lined shrink tubing
- ✔ Quick and easy hose identification
- ✔ Flame resistant
- ✔ 2:1 shrink ratio
- ✔ Wide operating temperature range: -57°F to +275°F
- ✔ Clean, durable, and long lasting
- ✔ Improves organization, visibility, and identification

I.D. (INCH)	Part Number							
	Black	Blue	Clear	Green	Orange	Red	White	Yellow
1.00"	RCT-1.00-B	RCT-1.00-BL	RCT-1.00-CL	RCT-1.00-GR	RCT-1.00-O	RCT-1.00-R	RCT-1.00-W	RCT-1.00-Y
1.50"	RCT-1.50-B	RCT-1.50-BL	RCT-1.50-CL	RCT-1.50-GR	RCT-1.50-O	RCT-1.50-R	RCT-1.50-W	RCT-1.50-Y
2.00"	RCT-2.00-B	RCT-2.00-BL	RCT-2.00-CL	RCT-2.00-GR	RCT-2.00-O	RCT-2.00-R	RCT-2.00-W	RCT-3.00-Y
3.00"	RCT-3.00-B	RCT-3.00-BL	RCT-3.00-CL	RCT-3.00-GR	RCT-3.00-O	RCT-3.00-R	RCT-3.00-W	RCT-3.00-Y
4.00"	RCT-4.00-B	RCT-4.00-BL	RCT-4.00-CL	RCT-4.00-GR	RCT-4.00-O	RCT-4.00-R	RCT-4.00-W	RCT-4.00-Y

WE KIT PROJECTS SO YOU CAN BUILD

COMPLETE HOSE, FITTING & ACCESSORY KITS – READY WHEN YOU NEED THEM

Save time. Eliminate guesswork. Reduce downtime. We kit everything you need for your project – hoses, fittings, adapters, protection and more – all organized, labeled and ready to go.

Each kit is clearly labeled with part numbers for easy identification, reordering, and consistent assembly every time.



KIT SOLUTIONS INCLUDE:

- ✔ Custom hose assemblies
- ✔ Fittings, adapters & couplers
- ✔ Hose protection (sleeves, guards, wraps)
- ✔ Color coding & identification
- ✔ Part number labeling on every item
- ✔ Kits organized by machine, attachment or system
- ✔ Delivered ready for install

EVERYTHING YOU NEED.
ONE KIT.



SAVE TIME

Pre-assembled and organized for fast, easy installation



REDUCE DOWNTIME

Keep your equipment running with the right parts on hand



CONSISTENT & RELIABLE

Standardize your equipment with the same quality parts every time

PERFECT FOR:

- ✔ OEMs outfitting attachments and equipment
- ✔ Maintenance kits for machines and fleet equipment
- ✔ Retrofit and repair projects
- ✔ Emergency spare part kits
- ✔ Plant and facility maintenance



PROJECT KIT EXCAVATOR BUCKET ATTACHMENT		
CONTENTS		
QTY	DESCRIPTION	PART NUMBER
2	HOSE ASSEMBLY 3/8" X 72'	HSAE-06-06FJ-06FJ-72
2	HOSE ASSEMBLY 3/8" X 48'	HSAE-06-06FJ-06FJ-48
4	JIC 3/8" MALE 90° SWIVEL	2404-06-06
2	JIC 3/8" FEMALE SWIVEL	2404-06-06F
2	ORB 3/8" MALE X JIC 3/8" FEM	6304-06-06
2	HOSE GUARD 3/8" X 24" YELLOW	HP-08Y-34
6	COLOR SHIRINK TUBE YELLOW	ICT-1.00-Y

ON-SITE SOLUTIONS. REAL RESULTS.

Our team can come to your facility to inspect and evaluate your equipment. We'll:

- ✔ Review problem areas and failures
- ✔ Identify, measure and document all hoses and connections
- ✔ Create custom item numbers for easy reordering
- ✔ Provide solutions that improve reliability and reduce downtime



WE DO THE WORK. YOU GET THE RESULTS.

KITTED. LABELED. DELIVERED. READY.

THREAD INFORMATION

Thread Identification



JIC (37° Flare) Fittings

JIC fittings use a 37° flare seating surface to create a dependable metal-to-metal seal. With straight threads and no need for sealant, they offer a durable, reusable connection ideal for high-pressure hydraulic and fluid transfer applications.

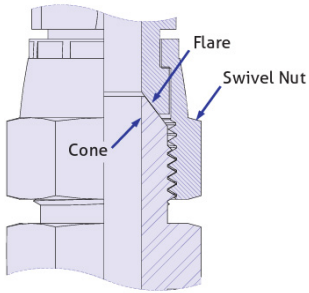

Dash Size	Tube Size	Thread	Working Pressure	
			Male	Female Swivel Nut
			(psi)	(psi)
02	1/8	5/16-24	5000	5000
03	3/16	3/8-24	5000	5000
04	1/4	7/16-20	5000	4500
05	5/16	1/2-20	5000	4000
06	3/8	9/16-18	5000	4000
08	1/2	3/4-16	4500	4000
10	5/8	7/8-14	3500	3000
12	3/4	1-1/16-12	3500	3000
14	7/8	1-3/16-12	3000	2500
16	1	1-5/16-12	3000	2500
20	1 1/4	1-5/8-12	2500	2000
24	1 1/2	1-7/8-12	2000	1500
32	2	2-1/2-12	1500	1125

ORB (O-Ring Boss) Fittings

ORB fittings use straight threads with an O-ring at the base to create a secure, leak-free seal. Designed for reliable performance without thread sealant, they are ideal for hydraulic systems and other high-pressure fluid applications. Elbows and tees feature adjustable lock nuts, allowing for proper orientation during installation without compromising the seal.

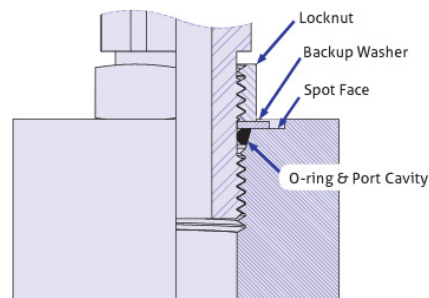
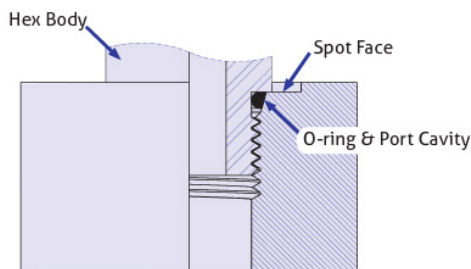

NPT (National Pipe Thread) Fittings

NPT fittings use tapered threads that seal through thread interference, creating a tight connection as they are tightened. Thread sealant or PTFE tape is required to ensure a leak-free seal. Commonly used in low to medium pressure applications, NPT fittings are widely found in hydraulic, plumbing, and general fluid transfer systems.

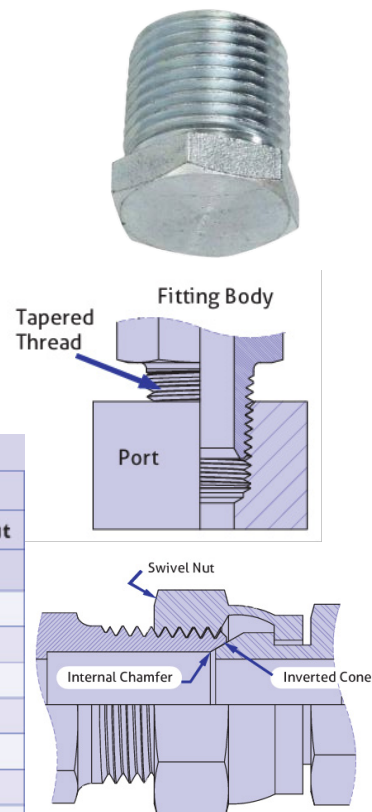

NPT, NPTF, and NPSM Pipe Specifications				
Dash Size	Thread Size	Major OD* (inch)	Working Pressure	
			NPT, NPTF Male and Female (psi)	NPSM Female Swivel Nut (psi)
02	1/8-27	.405	5000	5000
04	1/4-18	.540	5000	5000
06	3/8-18	.675	4000	4000
08	1/2-14	.84	3000	3500
12	3/4-14	1.050	2500	2250
16	1-11 1/2	1.315	2000	2000
20	1 1/4-11 1/2	1.660	1150	1625
24	1 1/2-11 1/2	1.900	1000	1250
32	2-11 1/2	2.375	1000	1125

Thread Identification

ORFS (O-Ring Face Seal) Fittings

ORFS fittings use a flat face sealing surface with an O-ring to create a reliable, leak-free connection. The seal is formed by compressing the O-ring between two flat faces, making them ideal for high-pressure and vibration-heavy applications. ORFS fittings are commonly used in hydraulic systems where leak prevention is critical.

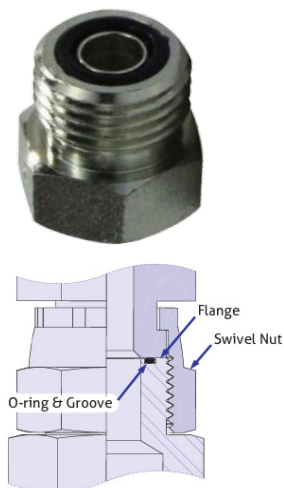

Dash Size	Tube Size	Thread Size	Working Pressure	
			Male (psi)	Female Swivel Nut (psi)
04	1/4	9/16-18	6000	6000
06	3/8	11/16-16	6000	6000
08	1/2	13/16-16	6000	6000
10	5/8	1-14	6000	6000
12	3/4	1-3/16-12	6000	6000
16	1	1-7/16-12	6000	5000
20	1 1/4	1-11/16-12	4000	4000
24	1 1/2	2-12	4000	3000

SAE Code 61 / Code 62 Flange Fittings

SAE Code 61 and Code 62 flange fittings provide a secure, high-strength connection for hydraulic systems using a flat face seal with an O-ring. The connection is clamped together with a split flange and bolts, ensuring even load distribution and a reliable seal.

Code 61 flanges are typically used in standard-pressure applications, while Code 62 flanges are designed for higher-pressure systems. These fittings are commonly found in heavy equipment and industrial applications where durability and leak resistance are critical.

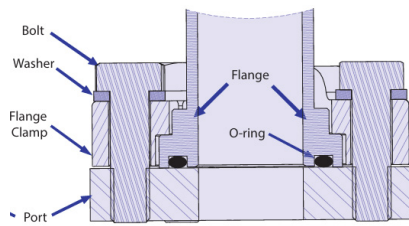

Flange Code 61 Dimensions								
Dash Size	Tube Size	C	E	Q	GG	A	Z INCH Threads	Z METRIC Threads
08	1/2	1.188	0.268	1.5	0.688	0.50	5/16-18	M8 x 1.25
12	3/4	1.500	0.268	1.875	0.875	0.75	3/8-16	M10 x 1.5
16	1	1.750	0.315	2.063	1.031	1.00	3/8-16	M10 x 1.5
20	1 1/4	2.000	0.315	2.312	1.188	1.25	7/16-14	M10 x 1.5
24	1 1/2	2.375	0.315	2.750	1.406	1.50	1/2-13	M12 x 1.75
32	2	2.812	0.378	3.062	1.688	2.00	1/2-13	M12 x 1.75
40	2 1/2	3.312	0.378	3.500	2.000	2.50	1/2-13	M12 x 1.75
48	3	4.000	0.378	4.188	2.438	3.00	5/8-11	M16 x 2
56	3 1/2	4.500	0.445	4.750	2.750	3.50	5/8-11	M16 x 2
64	4	5.000	0.445	5.125	3.062	4.00	5/8-11	M16 x 2

Hex head bolts are grade 5 and socket head cap bolts are grade 8.

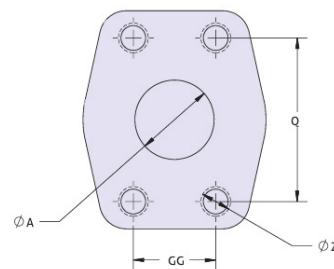
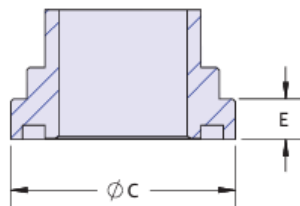

Flange Code 62 Dimensions								
Dash Size	Tube Size	C	E	Q	GG	A	Z INCH Threads	Z METRIC Threads
08	1/2	1.250	0.305	1.594	0.718	0.50	5/16-18	M8 x 1.25
12	3/4	1.625	0.345	2.00	0.937	0.75	3/8-16	M10 x 1.5
16	1	1.875	0.375	2.250	1.093	1.00	7/16-14	M12 x 1.75
20	1 1/4	2.125	0.405	2.625	1.250	1.25	1/2-13	M14 x 2.0
24	1 1/2	2.500	0.495	3.125	1.437	1.50	5/8-11	M16 x 2.0
32	2	3.125	0.495	3.812	1.750	2.00	3/4-10	M20 x 2.5

Note: Hex head bolts are grade 5 and socket head cap bolts are grade 8.

Thread Identification

BSPP (British Standard Pipe Parallel) Fittings

BSPP fittings use straight (parallel) threads and seal using a bonded washer, O-ring, or metal-to-metal seat rather than the threads themselves. Because of this, they do not require thread sealant when used with the proper sealing method.

Elbows and tees are available with jam nuts, allowing for easy orientation during installation while maintaining a proper seal.

Commonly used in European and international equipment, BSPP fittings are found in hydraulic and fluid transfer systems where a reliable, reusable connection is required.

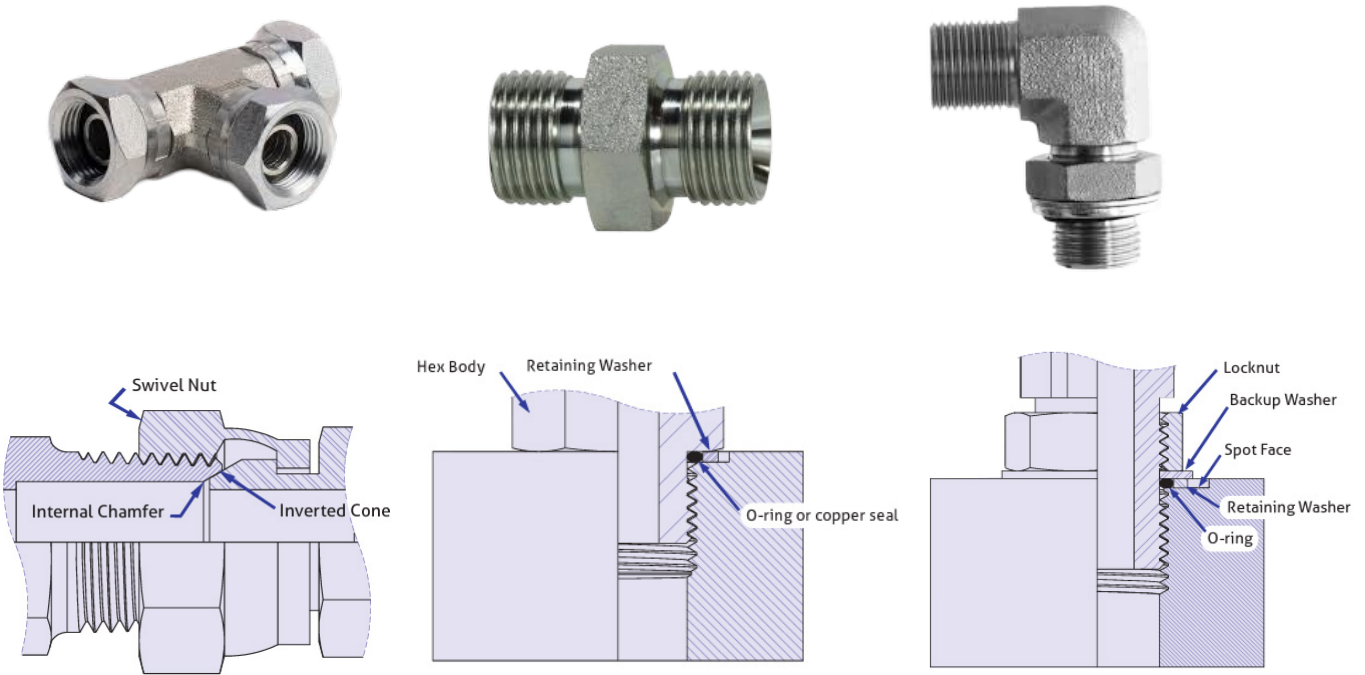

Dash Size	BSPT & BSPP	
	THREAD SIZE	MAJOR OD*
		(inch)
02	1/8-28	0.383
04	1/4-19	0.518
06	3/8-19	0.656
08	1/2-14	0.825
10	5/8-14	0.929
12	3/4-14	1.041
16	1-11	1.309
20	1 1/4-11	1.650
24	1 1/2-11	1.882
32	2-11	2.347

Metric Port Fittings

Metric port fittings use straight metric threads and seal with an O-ring or sealing washer at the base of the port. The seal is created independently of the threads, providing a reliable, leak-free connection without the need for thread sealant.

Commonly found in European and imported equipment, metric port fittings are used in hydraulic systems where consistent sealing and easy serviceability are required.



Metric Port (retained & captive seal)
(ISO 9974-1 & 9974-2)

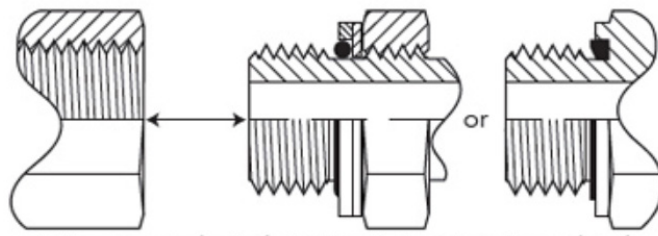

This category also includes bonded washers & metal seals

Metric Port (boss seal)
(ISO 6149)

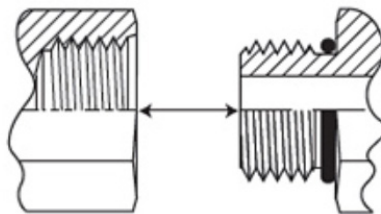

Employs seal without retaining ring

Metric Compression Fittings

Metric port fittings use a compression style connection that can either accept hoses or tubes interchangeably. The size of fitting is based on the tube diameter and thread size. L series fittings are typically found on 1/4" - 1/2" high pressure, but tend to be lower pressure above 1/2". S Series fittings are typically found on large diameter hoses and tend to be high pressure applications only.

Commonly found in European and imported equipment, metric fittings are used in hydraulic systems where consistent sealing and easy serviceability are required.

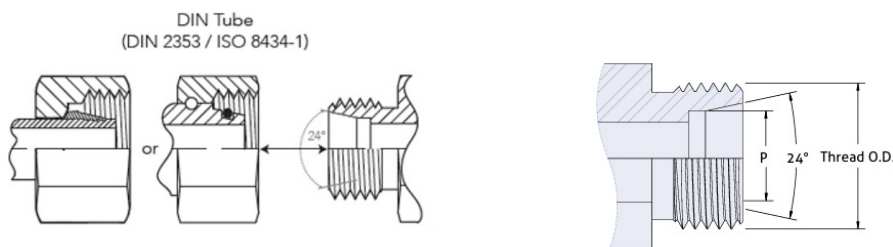

DIN L			
Metric Tube O.D. Size	Thread O.D.	Tube (P)ilot	Pressure
(mm)	(mm)	(mm)	(psi)
6	12 x 1.5	6	3600
8	14 x 1.5	8	3600
10	16 x 1.5	10	3600
12	18 x 1.5	12	3600
15	22 x 1.5	15	3600
18	26 x 1.5	18	2300
22	30 x 2.0	22	2300
28	36 x 2.0	28	1500
35	45 x 2.0	35	1500
42	52 x 2.0	42	1500

DIN S			
Metric Tube O.D. Size	Thread O.D.	Tube (P)ilot	Pressure
(mm)	(mm)	(mm)	(psi)
6	14 x 1.5	6	9000
8	16 x 1.5	8	9000
10	18 x 1.5	10	9000
12	20 x 1.5	12	9000
14	22 x 1.5	14	5800
16	24 x 1.5	16	5800
20	30 x 2.0	20	5800
25	36 x 2.0	25	5800
30	42 x 2.0	30	3600
38	52 x 2.0	38	3600

Thread Identification

JIS Metric Komatsu

Komatsu fittings have a 1.5mm thread pitch in all sizes and seals via a 30°/60° cone seat. If you identify a Metric thread with a nose cone be very careful to distinguish if it's actually a 30°/60° (Komatsu) cone seat instead of 37°/74° (GB Chinese).

Commonly found Komatsu equipment, metric fittings are used in hydraulic systems where consistent sealing and easy serviceability are required.

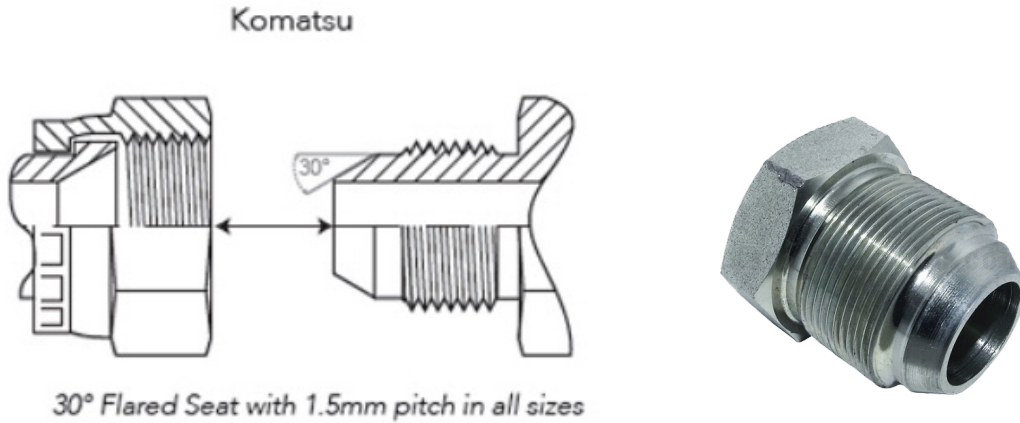

JIS BSPP

Komatsu fittings have a 1.5mm thread pitch in all sizes and seals via a 30°/60° cone seat. If you identify a Metric thread with a nose cone be very careful to distinguish if it's actually a 30°/60° (Komatsu) cone seat instead of 37°/74° (GB Chinese).

Commonly found Komatsu equipment, metric fittings are used in hydraulic systems where consistent sealing and easy serviceability are required.

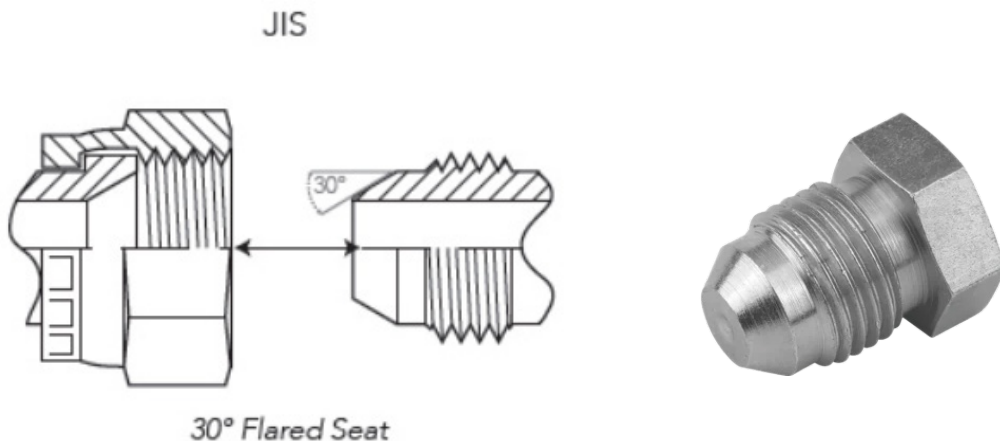

PRODUCT CATALOG

QH HOSE SHOP



SCAN TO SHOP
QHHOESHOP.COM

FIND WHAT YOU NEED. FAST & EASY. //

01



HYDRAULIC
ADAPTERS

02



HOSE CRIMPERS
AND EQUIPMENT

03



HYDRAULIC
HOSE & FITTINGS

04



BRASS
ADAPTERS

05



INDUSTRIAL HOSE,
FITTINGS, VALVES,
CLAMPS

06



QUICK DISCONNECT
FITTINGS

07



FASTENERS
AND HARDWARE

08



SHOP SUPPLIES,
METAL WORKING,
RIGGING



2460 COMMERCIAL BLVD
STATE COLLEGE, PA 16801



(814) 954-5752



SALES@QHHOESHOP.COM



WWW.QHHOESHOP.COM



TOTAL HYDRAULIC &
INDUSTRIAL SOLUTIONS



SCAN TO SHOP
QHHOSESHOP.COM

HYDRAULIC HOSE AND COUPLINGS CATALOG

/// 2026 EDITION ///



PREMIUM QUALITY PRODUCTS

Engineered for reliability and performance.



EXTENSIVE PRODUCT RANGE

Hoses, fittings, valves, clamps and accessories for any industrial application.



FAST & RELIABLE SERVICE

Quick processing and on-time delivery you can count on.



EXPERT SUPPORT

Knowledgeable team ready to help you find the right solution.



2460 COMMERCIAL BLVD
STATE COLLEGE, PA 16801



(814) 954-5752



SALES@QHHOSESHOP.COM